

19" RACKMOUNT

Industrial Computer Chassis



ISO 9001
BUREAU VERITAS
Certification



TW07002Q

www.premiercomputer.de



M

anagement Philosophy

Frugality

Sincerity

Innovation

Accountable

Company Profile

Established in 1972, Guanghsing located in the northern part of Taiwan, is one of the leaders in providing 19" Rackmount chassis, Storage, Wall Mount, and Compact PCI enclosures to Industrial Automation, Networking, ISP, Computer Telephony and Medical field. From custom designed rackmount chassis to our custom designed enclosures, Guanghsing products has been perennially recognized and well acknowledged by our customers as an Innovative, Top-Quality and Cost-Effective products.

By utilizing the advanced CAD/CAM design tools, Guanghsing's enclosures are one of the best cases available today. All of Guanghsing's in-house designed products are rugged, stable and made from premium quality steel. In order to ensure the quality and reduce total cost of ownership, Guanghsing documents every process and procedure to ensure that ISO is practiced and implemented through out the whole operation.

Guanghsing is dedicated to putting the same level of commitment and care to producing customized products as we are to customer service. We have an ongoing relationship with all our customers to discuss and review materials and production planning. From designing to final assembly, Guanghsing has the capability to meet all customization requirements.

In our 100,000+ square feet facility, manufacturing process is controlled by sophisticated equipment, well trained employees and each chassis is put through our strict Quality Management Team to ensure high standards and low failure rates. Our Sales Team are always dedicated to the prompt service and our engineers provide adaptive solutions for all customers' needs. We are here to achieve Total Customer Satisfaction!

Our facilities currently consist of these machineries:

Press Line:

Cross-Shaft Precision Press 25ton-250ton: 16 sets.
Shuttle Robot Line Precision Press 150ton: 6 sets.
Shuttle Robot Line Precision Press 200ton: 6 sets.

Spot Welding Line:

Spot Welding Machine: 16 sets.
Cap Spot Welding Machine: 2 sets.
Multi-Spindle Spot Welding Machine: 2 sets.
Multi-Spindle Rivet Fastening Machine: 6 sets.

Assembly Line:

Assembly Line 30M: 3 lines.

Guanghsing is perpetually researching and developing innovative and cost effective methods to provide quality products at reasonable pricing. We are striving forward in order to provide YOU with the latest technology. Our goal is to deliver:

Quality Assured, Cost Effective Chassis Solutions





RACKMOUNT CHASSIS SERIES

GHI-100/101	1U Rackmount Chassis	11
GHI-104/104DX	2U Rackmount Chassis	12
GHI-105/105DX	1U Rackmount Chassis	13
GHI-106	1U Rackmount Chassis	14
GHI-107	1U Rackmount Chassis	15
GHI-107A	1U Rackmount Chassis	16
GHI-108	1U Rackmount Chassis	17
GHI-109	1U Rackmount Chassis	18
GHI-110	1U Rackmount Chassis	19
GHI-112	1U Rackmount Chassis	20
GHI-113	1U Rackmount Chassis	21
GHI-114	1U Rackmount Chassis	22
GHI-142	1U Rackmount Chassis	23
GHI-160	1U Rackmount Chassis	24
GHI-170	1U Rackmount Chassis	25
new GHI-171	1U Rackmount Chassis	26
GHI-180	1U Rackmount Chassis	27
GHI-181	1U Rackmount Chassis	28
new GHI-182	1U Rackmount Chassis	29
GH-188ATX	1U Rackmount Chassis	30
GHI-189	1U Rackmount Chassis	31
GHI-192	1U Rackmount Chassis	32
GHI-200	2U Rackmount Chassis	33
GHI-201	2U Rackmount Chassis	34
GHI-202	2U Rackmount Chassis	35
GHI-210	2U Rackmount Chassis	36
GH-212ATX	2U Rackmount Chassis	37
GHI-213	2U Rackmount Chassis	38
GHI-214	2U Rackmount Chassis	39
GHI-220	2U Rackmount Chassis	40
GHI-221	2U Rackmount Chassis	41
GH-231ATX	2U Rackmount Chassis	42
GH-232ATX	2U Rackmount Chassis	43
GHI-240	2U Rackmount Chassis	44
GHI-243	2U Rackmount Chassis	45
GHI-246	2U Rackmount Chassis	46
GHI-247	2U Rackmount Chassis	47
new GHI-248	2U Rackmount Chassis	48
new GHI-249	2U Rackmount Chassis	49
GHI-250	2U Rackmount Chassis	50
GHI-251	2U Rackmount Chassis	51
GHI-252V/252H	2U Rackmount Chassis	52
GHI-253	2U Rackmount Chassis	53
new GHI-254	2U Rackmount Chassis	54
new GHI-255	2U Rackmount Chassis	55
GHI-260	2U Rackmount Chassis	56
GHI-270	2U Rackmount Chassis	57
GHI-280/280V	2U Rackmount Chassis	58
GHI-281/281V	2U Rackmount Chassis	59
GHI-282/282V	2U Rackmount Chassis	60
GHI-283/283V	2U Rackmount Chassis	61
GH-288SR	2U Rackmount Chassis	62
GHI-289	2U Rackmount Chassis	63
GHI-290/290V	2U Rackmount Chassis	64
GHI-293/293V	2U Rackmount Chassis	65
GHI-XP2	2U Rackmount Chassis	66
GH-310ATXR	3U Rackmount Chassis	67
GHI-312	3U Rackmount Chassis	68
GHI-313	3U Rackmount Chassis	69
GHI-314	3U Rackmount Chassis	70
GHI-315	3U Rackmount Chassis	71
GHI-342ATX	3U Rackmount Chassis	72
GHI-346	3U Rackmount Chassis	73
new GHI-347	3U Rackmount Chassis	74
GHI-350	3U Rackmount Chassis	75
GHI-351	3U Rackmount Chassis	76
GHI-352	3U Rackmount Chassis	77
GHI-353	3U Rackmount Chassis	78
GHI-354	3U Rackmount Chassis	79
GHI-359	3U Rackmount Chassis	80
GHI-360	3U Rackmount Chassis	81
GHI-380	3U Rackmount Chassis	82
GHI-381	3U Rackmount Chassis	83
GHI-390	3U Rackmount Chassis	84
GHI-A30	3U Rackmount Chassis	85
GHI-A31	3U Rackmount Chassis	86
GHI-A32	3U Rackmount Chassis	87
GHI-A33	3U Rackmount Chassis	88
new GHI-C30	3U Rackmount Chassis	89
GHI-M30	3U Rackmount Chassis	90
new GHI-M31	3U Rackmount Chassis	91
GH-400ATX/400S	4U Rackmount Chassis	92
GH-402ATXR/402SR	4U Rackmount Chassis	93
GHI-403ATXR/403SR	4U Rackmount Chassis	94
GHI-404	4U Rackmount Chassis	95
GHI-405	4U Rackmount Chassis	96
GHI-406ATXR/406SR	4U Rackmount Chassis	97
GHI-407	4U Rackmount Chassis	98
new GHI-408ATXR/SR	4U Rackmount Chassis	99
new GH-410ATXR/410SR	4U Rackmount Chassis	100
GH-411ATXR/411SR	4U Rackmount Chassis	101
GH-414ATXR/414SR	4U Rackmount Chassis	102
GHI-415ATXR/415SR	4U Rackmount Chassis	103
GH-416ATXR/416SR	4U Rackmount Chassis	104
GH-418ATXR/418SR	4U Rackmount Chassis	105
GHI-419ATXR/419SR	4U Rackmount Chassis	106
GH-430ATXR/430SR	4U Rackmount Chassis	107
GH-431ATXR/431SR	4U Rackmount Chassis	108
GH-432ATXR/432SR	4U Rackmount Chassis	109
GHI-433	4U Rackmount Chassis	110
GHI-440	4U Rackmount Chassis	111
GHI-441	4U Rackmount Chassis	112
GHI-442	4U Rackmount Chassis	113
GHI-443	4U Rackmount Chassis	114
GHI-450	4U Rackmount Chassis	115
GHI-451ATXR/451SR	4U Rackmount Chassis	116
GHI-460	4U Rackmount Chassis	117
GHI-479	4U Rackmount Chassis	118
GHI-480	4U Rackmount Chassis	119
GHI-481	4U Rackmount Chassis	120

GHI-4F1ATXR/4F1SR	4U Rackmount Chassis	121
GHI-4F2	4U Rackmount Chassis	122
GHI-M40ATXR/M40SR	4U Rackmount Chassis	123
GHI-M41ATXR/M41SR	4U Rackmount Chassis	124
GHI-P02	4U Rackmount Chassis	125
new GH-520SR/530ATXR	5U Rackmount Chassis	126
GHI-528	5U Rackmount Chassis	127
GHI-580	5U Rackmount Chassis	128
GHI-581	5U Rackmount Chassis	129
GHI-583	5U Rackmount Chassis	130
GHI-584	5U Rackmount Chassis	131
new GHI-591	5U Rackmount Chassis	132
GH-600ATXR/620SR	6U Rackmount Chassis	133
GHI-611ATXR/611SR	6U Rackmount Chassis	134
GHI-690	6U Rackmount Chassis	135
GHI-691	6U Rackmount Chassis	136
GHI-791	7U Rackmount Chassis	137
GH-800ATXR/820SR	8U Rackmount Chassis	138
GHI-891	8U Rackmount Chassis	139
GHI-P01	8U Rackmount Chassis	140
GHB-B01	Multi-Funtion Chassis	141
GHB-B04	6U-1/4 Rackmount Chassis	142
GHB-B05	Multi-Funtion Chassis	143
GHB-B08	6U-1/2 Rackmount Chassis	144
GHB-030	5U-1/4 Rackmount 3-Slot Micro Box	145
GHB-042	6U-1/4 Rackmount Chassis	146
GHB-043	6U-1/4 Rackmount Chassis	147
GHB-060	6-Slot Micro Box Chassis	148
GHB-061	6-Slot Micro Box Chassis	149
GHB-062-6	6-Slot Micro Box Chassis	150
GHB-062-8	8-Slot Micro Box Chassis	151
GHB-080	8-Slot Micro Box Chassis	152
new GHB-081	8-Slot Micro Box Chassis	153
GHB-082-8	8-Slot Micro Box Chassis	154
GHB-082-10	10-Slot Micro Box Chassis	155
GHB-083-8	8-Slot Micro Box Chassis	156
GHB-083-10	10-Slot Micro Box Chassis	157
GHB-120ATXR/120SR	Flex/Micro ATX or 10/12 Slot Micro Box	158
GHK-M01	1U 15" LCD Monitor	159
GHK-M02	1U 15" LCD Monitor with 8 Ports KVM	160
GHK-M03	1U 17" LCD Monitor	161
GHK-M04	1U 17" LCD Monitor with 8 Ports KVM	162
GH-K02	1U Rackmount Keyboard Drawer	163
GH-KD1	1U Rackmount Keyboard Drawer	163
GH-KD4	1U Rackmount Keyboard Drawer	163

COMPACT PCI SERIES

GHC-C01	1U Compact PCI	164
GHC-C02	2U Compact PCI	165
GHC-C03	3U Compact PCI	166
GHC-C04	4U Compact PCI	167
GHC-P03	8U Compact PCI	168
OEM		169

STORAGE & SERVER SERIES

GHR-190	1U Rackmount Storage Chassis	170
GHR-192	1U Rackmount Storage Chassis	171
GHR-219	2U Rackmount Storage Chassis	172
GHR-290	2U Rackmount Storage Chassis	173
GHR-390	3U Rackmount Storage Chassis	174
GHR-422	4U Rackmount Storage Chassis	175
GHS-1500	Server Case	176
GHS-2000	Server Case	177
GHK-325	Hot-Swappable Disk Array	178
GHK-425	Hot-Swappable Disk Array	178
GHK-431/541	Hot-Swappable Disk Array	179

ACCESSORIES

GHA-CO01	Thermal Management Card	180
GHA-CO02	Thermal Management Card	
GHA-CO03	Thermal Management Card	
GHA-CO04	Thermal Management Card	
GHA-CO05	Thermal Management Card	
GHA-BRM1	IPC Accessory	
GHA-SL20/SL24/SL26	Slide Rail	181
GHA-SL20-1U/SL24-1U	Slide Rail	
RL-CC1001-99-0104/	Slide Rail	
CC3001-00-0240/	Slide Rail	
CC3001-00-0260	Slide Rail	
GHA-RSP-1U	Rackmount Extension Bracket	
GHA-RSP-2U	Rackmount Extension Bracket	
GHA-H199	3.5" HDD Bracket	182
GHA-H300	3.5" HDD Bracket	
GHA-H432	3.5" HDD Bracket	
GHA-H211	3.5" HDD Bracket	
GHA-H311	3.5" HDD Bracket	
GHA-H414	3.5" HDD Bracket	
GHA-H431	3.5" HDD Bracket	183
GHA-410	Hold Down Bar	
GHA-418	Hold Down Bar	
GHA-TE01	Hold Down Bar	
GHA-YT01	Hold Down Bar	
GHA-SR242	Slim CD-ROM	
GHA-D353	Slim FDD	184
SDW-082S	Slim DVD-RW	
SDR-083	Slim DVD-R	
GHA-H280	3.5" HDD Bracket	
GHA-H380	3.5" HDD Bracket	
GHA-H480	3.5" HDD Bracket	
GHA-F123	Cooling Fan	185
GHA-F418	Cooling Fan	
GHA-F520	Cooling Fan	
GHA-SAS-A	SAS Expander	
GHA-SAS-B	SAS Expander	
GHA-SAS-C	SAS Expander	
GHA-4HL	IPC Accessory	186
GHA-4UL	IPC Accessory	
GHA-4UH	IPC Accessory	
GHA-3UA/GHA-4UA	IPC Accessory	
GHA-K005	USB & PS2 Adapter	
GHA-K006	USB Adapter	

GHA-K002	Coupling Adapter	187
GHA-K003	Adapter	
GHA-K004	Adapter	
GHA-K007	Adapter	
GHA-K008	Adapter	
GHA-K009	Adapter	
GHA-690A/B/C/D	GHI-690/691 Extra Device	188
GHA-M06	1U 17" LCD Module	
GHA-M07	1U 17" LCD Module	
GHA-FM01	Drive Adapter	189
GHA-FM03/FH03	Drive Adapter	
GHA-FM04/FH04	Drive Adapter	
GHA-FM05/FH05	Drive Adapter	
GHA-FM06	Drive Adapter	
GHA-FM07	Drive Adapter	
GHA-FM09	Drive Adapter	190
GHA-F10	Drive Adapter	
GHA-F11	Drive Adapter	
GHA-FM801	Drive Adapter	
GHA-H01	Drive Adapter	
GHA-1520	Rackmount Accessory	
GHA-DVR-17H	DVR Rear Window	191
GHA-BW205	2-slots Rear Window	
GHA-BW206	2-slots Rear Window	
GHA-BW256	2-slots Rear Window	
GHA-BW305	3-slots Rear Window	
GHA-BW306	3-slots Rear Window	

PASSIVE BACKPLANE & RISER CARD

GHP-100	1-slot Riser Card	193
GHP-R0101	1-slot Riser Card	
GHP-R0102	1-slot Riser Card	
GHP-R0103	1-slot Riser Card	
GHP-PCI106H	1-slot Riser Card	
GHP-R0110(GHP-141)	1-slot Riser Card	
GHP-R0111	1-slot Riser Card	
GHP-R0119	1-slot Riser Card	
GHP-R0309	1-slots Riser Card	
GHP-08X16	1-slot Riser Card	
GHP-R0112	1-slots Riser Card	194
GHP-R0113	1-slots Riser Card	
GHP-19X16	1-slot Riser Card	
GHP-R0104	1-slot Riser Card	
GHP-200	3-slots Riser Card	
GHP-R0321	3-slots Riser Card	
GHP-R0322	3-slots Riser Card	
GHP-R0323	3-slots Riser Card	
GHP-R0324	3-slots Riser Card	195
GHP-R0325	3-slots Riser Card	
GHP-R0326	3-slots Riser Card	
GHP-U740	3-slots Riser Card	
GHP-U746-C9	3-slots Riser Card	
GHP-U756	3-slots Riser Card	
GHP-U780	3-slots Riser Card	
GHP-U790	3-slots Riser Card	
GHP-205	1-slots Riser Card	196
GHP-206	1-slots Riser Card	
GHP-R0301	3-slots Riser Card	
GHP-R0302	3-slots Riser Card	
GHP-R0303	3-slots Riser Card	
GHP-R0304	3-slots Riser Card	
GHP-R0308	3-slots Riser Card	
GHP-2UX16	1-slots Riser Card	
GHP-3002	2-slots Backplane	197
GHP-3102	2-slots Backplane	
GHP-B2SD	2-slots Backplane	
GHP-G1UG1	2-slots Backplane	
GHP-AD3S2	3-slots Backplane	
GHP-N2UP5	5-slots Backplane	198
GHP-B4PS1	5-slots Backplane	
GHP-AD6S4	5-slots Backplane	
GHP-B6SD	6-slots Backplane	
GHP-P2UP4	6-slots Backplane	
GHP-2004	4-slots Backplane	199
GHP-2204	4-slots Backplane	
GHP-2006	6-slots Backplane	
GHP-2206	6-slots Backplane	
GHP-2308	8-slots Backplane	
GHP-2008	8-slots Backplane	
GHP-2208	8-slots Backplane	
GHP-2014	14-slots Backplane	
GHP-2214	14-slots Backplane	200
GHP-P14P4	14-slots Backplane	
GHP-2214D	14-slots Backplane	
GHP-2020S	20-slots Backplane	
GHP-2220	20-slots Backplane	
GHP-2220G	20-slots Backplane	
GHP-2220Q	20-slots Backplane	
GHP-2020	20-slots Backplane	
GHP-3305	5-slots Backplane	201
GHP-3410	10-slots Backplane	
GHP-3414	14-slots Backplane	
GHP-3608	8-slots Backplane	
GHP-3712	12-slots Backplane	
GHP-P14P12	14-slots Backplane	

19" OPEN RACK SERIES

19" Open Rack Series	202
19" Open Rack Series	203

Chassis Comparison Chart

Model	Mounting Configuration options			Board Options		Max. Number of Slots	Power Supply Options		Fan space#				
	Rack	Tower	Wall/ Panel	Passive B/P	M/B		Watts	P/S Type	4 cm	6 cm	8 cm	9 cm	12 cm
GHI-100	x			x		3	250~350	1U Single	3				
GHI-101	x			x		3	250~350	1U Single	3				
GHI-104	x				12"x13"	1	250~500	1U Single	3+2/6				
GHI-105	x				12"x9.6"	1	250~500	1U Single	3+2/5				
GHI-106	x				6.7"x6.7"	1	150~300	1U Single	★2				
GHI-107	x				12"x9.6"	1	250~400	1U Single	2				
GHI-107A	x				12"x10.5"	1	250~400	1U Single	3				
GHI-108	x				6.7"x6.7"	1	150~300	1U Single	3/4				
GHI-109	x				6.7"x6.7"	1	150~300	1U Single	(Heat Pipe)				
GHI-110	x				12"x9.6"	1	250~350	1U Single	2+3				
GHI-112	x				12"x9.6"	1	250~350	1U Single	3				
GHI-113	x				12"x13"	1	250~500	1U Single	7				
GHI-114	x				12"x13"	1	500	1U Single	6				
GHI-142	x				12"x13"	1	250~400	1U Redundant	7				
GHI-160	x				12"x13"	1	250~500	1U Single	6				
GHI-170	x				6.0"x13"x2	1+1	200~250	1U Single	6+2				
GHI-171	x				6.7"x6.7"x2		200	1U Single x2	3				
GHI-180	x				12"x13"	1	250~400	1U Single	6				
GHI-181	x				12"x13"	1	250~500	1U Single	6				
GHI-182	x				12"x13"	1	400W	1U Redundant	5				
GH-188ATX	x				12"x9.6"	1	180~300	1U Single	2+1				
GHI-189	x			x			250~500	1U Single	6+1				
GHI-192	x				12"x10.5"	1	250~500	1U Single	6				
GHI-200	x			x		6	250~400	PS/2 or Mini Redundant			3		
GHI-201	x			x		6	300~500	PS/2 Single or Mini Redundant			3		
GHI-202	x			x		3	250~300	1U Single			3		
GHI-210	x				12"x9.6"	3	250~400	PS/2 or Mini Redundant			3		
GH-212ATX	x				12"x9.6"	3	250~460	PS/2		1	1		
GHI-213	x				12"x9.6"	3	250~400	2U Single or Redundant			3		
GHI-214	x				12"x13"	3	600	2U Single or Redundant			3		
GHI-220	x				12"x10.5"	3	400	2U Single or Redundant			4		
GHI-221	x				12"x13"	3	600	2U Single or Redundant		1	4		
GH-231ATX	x				12"x13"	3	250~400	2U Single or Redundant			3		
GH-232ATX	x				12"x13"	3	250~460	PS/2		1	3		
GHI-240	x				16"x13"	3	600	2U Redundant	2		4		
GHI-243	x				12"x10.5"	3	250~400	2U			4		
GHI-246	x				12"x13"	3	600	2U Single or Redundant			4		
GHI-247	x				12"x13"	3	600	2U Single or Redundant			4		
GHI-248	x				12"x10.5"	3	400	2U Single or Redundant			3		
GHI-249	x				12"x13"	3	600	2U Single or Redundant			4		
GHI-250	x				12"x9.6"	5	250~300	1U Single			2		
GHI-251	x				12"x9.6"	7	250~300	1U Single			2		
GHI-252V	x				12"x9.6"	7	250~300	1U Single	2		1		
GHI-252H	x				12"x9.6"	3	250~300	1U Single	2		1		
GHI-253H	x				12"x9.6"	3	300	1U Single	2		1		
GHI-254	x				12"x9.6"	4	400	PS/2			1		
GHI-255	x				12"x9.6"	4	400	PS/2			1		
GHI-260	x				12"x13"	3	600	2U Single or Redundant			4		
GHI-270	x				6.7"x6.7"x2	1+1	150~250	1U Single x2			4		
GHI-280	x				12"x13"	3	600	2U Single or Redundant			4		
GHI-280V	x				12"x13"	7	600	2U Single or Redundant			4		
GHI-281	x				12"x13"	3	600	2U Single or Redundant			4		
GHI-281V	x				12"x13"	7	600	2U Single or Redundant			4		
GHI-282	x				12"x9.6"	3	510	2U Single or Redundant			4		
GHI-282V	x				12"x9.6"	7	510	2U Single or Redundant			4		
GHI-283	x				12"x13"	3	600	2U Single or Redundant			4		
GHI-283V	x				12"x13"	7	600	2U Single or Redundant			4		
GH-288SR	x			x		6	250~500	PS/2 or Mini Redundant			2		
GHI-289	x			x		6	300~600	2U Single or Redundant	1		4		
GHI-290	x				12"x13"	3	500	2U Single or Redundant			4		

Chassis Comparison Chart

Air Flow	Disk Mounting VD =Vibration Damping					Keyboard Connector		Dimensions (millimeters/inch)			Front Panel Indicator					Front Panel Controls					
	CFM/ EACH	2.5" Int	3.5" Int	3.5" H.S.	3.5" F.P.	5.25" F.P.	Front	Rear	Width	Height	Depth	P.S.	HD	Over Heat	Fan Fail	LAN	On/Off	LAN	USB	Reset	Keylock
7.0	1	2		Δ1	Δ1	x	x	483/19"	44/1.7"	450/17.7"	x	x				x		x	x		
7.0	1	2		Δ1	Δ1	x	x	483/19"	44/1.7"	450/17.7"	x	x				x		x	x		
10.8/15.3		2		1	1	x	x	483/19"	44/1.7"	605/23.8"	x	x				x		x	x		
10.8/15.3		2		1	1	x	x	483/19"	44/1.7"	542/21.3"	x	x				x		x	x		
7	1			1	1	x	x	483/19"	44/1.7"	220/8.7"	x	x				x		x	x		
15.3		2				x		483/19"	44/1.7"	382/15.0"	x	x				x			x		
15.3	1				Δ1	x	x	483/19"	44/1.7"	300/8.7"	x	x				x		x	x		
7	1	1			Δ1	x		483/19"	44/1.7"	382/15.0"	x	x				x		x	x		
N/A	1	1		1	Δ1	x	x	483/19"	44/1.7"	302/11.9"	x	x				x		x	x		
7.0/8.6		3		Δ1	Δ1	x	x	483/19"	44/1.7"	450/17.7"	x	x				x		x	x		
15.3		1		Δ1	Δ1	x	x	483/19"	44/1.7"	407/16.0"	x	x				x		x	x		
15.3			1	1	1		x	483/19"	44/1.7"	650/25.6"	x	x				x			x		
15.3		1		1	1	x	x	483/19"	44/1.7"	543/21.4"	x	x				x		x	x		
15.3		2		Δ1	Δ1		x	483/19"	44/1.7"	650/25.6"	x	x	x	x	x	x			x		
15.3	1		8(2.5")		Δ1	x	x	483/19"	44/1.7"	650/25.6"	x	x	x	x		x		x	x		
7/15.3		2				x	x	483/19"	44/1.7"	302/11.9"	x	x				x		x	x		
15.3			2					483/19"	44/1.7"	400/15.8"	x	x				x		x	x		
15.3			4	1	1	x	x	483/19"	44/1.7"	650/25.6"	x	x	x	x	x	x		x	x		
15.3			2		1	x	x	483/19"	44/1.7"	650/25.6"	x	x	x	x	x	x		x	x		
15.3			4	1	1			483/19"	44/1.7"	650/25.6"	x	x			x	x		x	x		
7.0	1			1	2		x	483/19"	44/1.7"	520/20.5"	x	x				x			x		
15.3/7			2		1	x	x	483/19"	44/1.7"	700/27.5"	x	x			x	x		x	x		
7.0			2		1+Δ1		x	483/19"	44/1.7"	560/22.1"	x	x				x		x	x		
42.5				1	1	x	x	483/19"	88/3.5"	450/17.7"	x	x				x		x	x		
42.5			2		Δ1	x	x	483/19"	88/3.5"	450/17.7"	x	x				x		x	x		
42.5		3			1	x	x	483/19"	88/3.5"	300/11.9"	x	x			x	x		x	x		
42.5		3		1	1		x	483/19"	88/3.5"	450/17.7"	x	x				x		x	x		
23.5/42.5		3		1	1	x	x	483/19"	88/3.5"	501/19.7"	x	x				x		x	x	x	
42.5		3		1	1	x	x	483/19"	88/3.5"	450/17.7"	x	x				x		x	x		
42.5		3		1	1+Δ1		x	483/19"	88/3.5"	510/20.1"	x	x				x		x	x		
42.5		2		1	4	x	x	483/19"	88/3.5"	570/22.4"	x	x			x	x		x	x		
23.5/42.5		2		1	4	x	x	483/19"	88/3.5"	650/25.6"	x	x			x	x		x	x		
42.5		3		2	2	x	x	483/19"	88/3.5"	650/25.6"	x	x				x		x	x	x	
23.5/42.5		5		1	1	x	x	483/19"	88/3.5"	650/25.6"	x	x				x		x	x	x	
15.3/42.5			4		Δ1	x	x	483/19"	88/3.5"	710/28.0"	x	x	x	x		x		x	x		
42.5		4		1	1		x	480/18.9"	88/3.5"	558/22.0"	x	x				x		x	x		
42.5			4		1	x	x	483/19"	88/3.5"	650/25.6"	x	x				x		x	x		
42.5			4		2+Δ1	x	x	483/19"	88/3.5"	650/25.6"	x	x	x	x	x	x		x	x		
42.5	2				4			483/19"	88/3.5"	570/22.4"	x	x				x		x	x		
42.5			4	1x3	1x5			483/19"	88/3.5"	650/25.6"	x	x				x		x	x		
42.5		1		Δ1	1		x	483/19"	88/3.5"	355/13.9"	x	x			x	x			x		
42.5		2			1	x	x	483/19"	88/3.5"	355/13.9"	x	x			x	x		x	x		
42.5/7.0		3		Δ1	1	x	x	483/19"	88/3.5"	355/13.9"	x	x			x	x		x	x		
42.5/7.0		3		Δ1	1	x	x	483/19"	88/3.5"	355/13.9"	x	x			x	x		x	x		
7.0/42.5		2			1	x	x	483/19"	88/3.5"	357/14.1"	x	x			x	x		x	x		
42.5		2	2		Δ1	x	x	483/19"	88/3.5"	383/15.1"	x	x				x		x	x		
42.5			2		1	x	x	483/19"	88/3.5"	383/15.1"	x	x				x		x	x		
42.5			16(2.5")		1	x	x	483/19"	88/3.5"	650/25.6"	x	x	x	x		x		x	x		
42.5		4				x	x	483/19"	88/3.5"	356/14.0"	x	x				x		x	x		
42.5	2		8	Δ1	Δ1	x	x	483/19"	88/3.5"	650/25.6"	x	x	x	x	x	x		x	x		
42.5	2		8	Δ1	Δ1	x	x	483/19"	88/3.5"	650/25.6"	x	x	x	x	x	x		x	x		
42.5	1		6	Δ1	1	x	x	483/19"	88/3.5"	650/25.6"	x	x	x	x	x	x		x	x		
42.5	1		6	Δ1	1	x	x	483/19"	88/3.5"	650/25.6"	x	x	x	x	x	x		x	x		
42.5	2		8	Δ1	Δ1	x	x	483/19"	88/3.5"	650/25.6"	x	x	x	x	x	x		x	x		
42.5	2		8	Δ1	Δ1	x	x	483/19"	88/3.5"	650/25.6"	x	x	x	x	x	x		x	x		
42.5		1	4		2	x	x	483/19"	88/3.5"	650/25.6"	x	x	x	x	x	x		x	x		
42.5		1	4		2	x	x	483/19"	88/3.5"	650/25.6"	x	x	x	x	x	x		x	x		
42.5		2		1	1	x	x	483/19"	88/3.5"	526/20.7"	x	x				x		x	x	x	
42.5	1		6	Δ1	1	x	x	483/19"	88/3.5"	700/27.5"	x	x	x	x	x	x		x	x		
42.5			12				x	483/19"	88/3.5"	650/25.6"	x	x	x	x	x	x		x	x		

(F)=Front (H)=Horizontal (V)=Vertical ☆=Optional kit for 3.5" internal Disk Mounting ★= Optional Fan Δ=For Slim Type Disk

Chassis Comparison Chart

Model	Mounting Configuration options			Board Options		Max. Number of Slots	Power Supply Options		Fan space#				
	Rack	Tower	Wall/ Panel	Passive B/P	M/B		Watts	P/S Type	4 cm	6 cm	8 cm	9 cm	12 cm
GHI-293	x				12"x10.5"	3	550	2U Single or Redundant			3		
GHI-XP2					12"x10.5"	3	240	Flex ATX		(Heat Pipe)			
GH-310ATXR	x				12"x9.6"	7	230~700	PS/2 or Mini Redundant			1	2	
GHI-312	x				12"x13"	7	460~700	2U Single or Redundant		1		5	
GHI-313	x				12"x10.5"	7	460~600	2U Single or Redundant		1		2	
GHI-314	x				12"x10.5"	7	460~700	2U Single or Redundant	4	2			1
GHI-315	x				12"x9.6"	7	460~700	2U Single or Redundant	2	2			
GHI-342	x				12"x13"	7	460~700	2U Single or Redundant		1		3	
GHI-346	x				12"x13"	7	460~650	2U/3U Single or Redundant		2		4	
GHI-347	x				12"x10.5"	7	700W	2U/3U Single or Redundant		★2		4	
GHI-350	x				12"x9.6"	7	300~460	2U Single	2	★1	2		
GHI-351	x				12"x9.6"	7	300~400	2U Single or Redundant		★2	2		
GHI-352	x				12"x9.6"	7	300~460	2U Single or Redundant	2	★1	1		
GHI-353	x				12"x10.5"	7	300~460	2U Single or Redundant	2	★2	1		
GHI-354	x				9.6"x9.6"	4	460	PS/2 or Mini Redundant		★1			1
GHI-359	x				12"x10.5"	7	300~700	2U/3U Single or Redundant	3	2			
GHI-360	x				12"x13"	7	460~650	2U Single or Redundant	2	1		4	
GHI-380	x				12"x13"	7	460~650	2U/3U Single or Redundant		2		4	
GHI-381	x				12"x13"	7	460~650	2U/3U Single or Redundant		2		4	
GHI-390	x				12"x13"	7	460~650	2U/3U Single or Redundant		2		4	
GHI-A30	x				12"x9.6"	7	500~600	2U/3U Single or Redundant	2	2	1		1
GHI-A31	x				12"x13"	7	300~650	2U Single or Redundant		2	3		
GHI-A32	x				12"x13"	7	300~650	2U Single or Redundant		2		3	
GHI-A33	x				12"x9.6"	7	500~700	2U Single or Redundant		2			2
GHI-C30	x				12"x13"	7	460~650	2U/3U Single or Redundant		2		4	
GHI-M30	x				12"x9.6"	7	500~600	2U Single or Redundant	2	2			
GHI-M31	x				12"x9.6"	7	500~600	2U Single or Redundant	2	2			
GH-400ATX	x				12"x9.6"	7	230~700	PS/2 Single			2		
GH-400S	x			x		14	230~700	PS/2 Single			2		
GH-402ATXR	x				12"x9.6"	7	230~700	PS/2 or Mini Redundant				2	
GH-402SR	x			x		14/15	230~700	PS/2 or Mini Redundant				2	
GHI-403ATXR	x				12"x9.6"	7	230~700	PS/2 or Mini Redundant				2	
GHI-403SR	x			x		14/15	230~700	PS/2 or Mini Redundant				2	
GHI-404	x				12"x13"	7	500~700	PS/2 or Redundant		★2		2	
GHI-405	x				12"x10.5"	7	500~700	PS/2 Single or Mini Redundant			3		1
GHI-406ATX	x				9.6"x9.6"	4	500~700	PS/2 Single or Mini Redundant		★2		2	
GHI-407	x				12"x9.6"	7	230~700	PS/2 or Mini Redundant		2		2	
GHI-408ATXR	x				12"x9.6"	7	230~700	PS/2 or Mini Redundant				2	
GHI-408SR	x			x		14/15	230~700	PS/2 or Mini Redundant				2	
GH-410ATXR	x				12"x9.6"	7	230~700	PS/2 or Mini Redundant					1+★1
GH-410SR	x			x		14/15	230~700	PS/2 or Mini Redundant					1+★1
GH-411ATXR	x				12"x9.6"	7	230~700	PS/2 or Mini Redundant					1
GH-411SR	x			x		14/15	230~700	PS/2 or Mini Redundant					1
GH-414ATXR	x				12"x9.6"	7	230~700	PS/2 or Mini Redundant					1+★1
GH-414SR	x			x		14/15	230~700	PS/2 or Mini Redundant					1+★1
GHI-415ATXR	x				12"x13"	7	230~700	PS/2 or Mini Redundant		★2		3	
GH-416ATXR	x				12"x9.6"	7	230~700	PS/2 or Mini Redundant					1+★1
GH-416SR	x			x		14/15	230~700	PS/2 or Mini Redundant					1+★1
GH-418ATXR	x				12"x9.6"	7	230~700	PS/2 or Mini Redundant				★3	1
GH-418SR	x			x		14	230~700	PS/2 or Mini Redundant				★3	1
GHI-419ATX	x				12"x13"	7	230~700	PS/2 or Mini Redundant		★2		2	
GHI-419SR	x			x		14/15	230~700	PS/2 or Mini Redundant		★2		2	
GH-430ATXR	x				12"x13"	7	300~700	PS/2 or Mini Redundant			★1	4	
GH-430SR	x			x		19	300~700	Vertical Redundant(F)				4	
GH-431ATXR	x				12"x13"	7	230~700	PS/2 or Mini Redundant				4	
GH-431SR	x			x		14/15	230~700	PS/2 or Mini Redundant				4	
GH-432ATXR	x				12"x13"	7	230~700	PS/2 or Mini Redundant(F)			★1	4	
GH-432SR	x			x		19	230~700	PS/2 or Mini Redundant(F)				4	
GHI-433	x				12"x10.5"	7	500~700	PS/2 Single or Mini Redundant		★2			3
GHI-440	x				12"x13"	7	230~700	PS/2 or Mini Redundant		★2			3
GHI-441	x				12"x10.5"	7	230~700	PS/2 or Mini Redundant		★2			3
GHI-442	x				12"x13"	7	230~700	PS/2 or Mini Redundant		★2			3
GHI-443	x				12"x13"	7	500~700	PS/2 or Mini Redundant		★2			3

Chassis Comparison Chart

Air Flow	Disk Mounting VD =Vibration Damping					Keyboard Connector		Dimensions (millimeters/inch)			Front Panel Indicator					Front Panel Controls					
	CFM/ EACH	2.5" Int	3.5" Int	3.5" H.S.	3.5" F.P.	5.25" F.P.	Front	Rear	Width	Height	Depth	P.S.	HD	Over Heat	Fan Fail	LAN	On/Off	LAN	USB	Reset	Keylock
42.5			4	1	2	x	x	483/19"	88/3.5"	560/22.1"	x	x			x	x		x	x		
N/A	2				1	x	x	420/16.5"	89/3.5"	385/15.2"	x	x	x			x		x	x		
42.5/51		3		1	2	x	x	483/19"	133/5.2"	526/20.7"	x	x				x			x	x	
23.5/51		7+☆2		1	2	x	x	483/19"	133/5.2"	650/25.6"	x	x				x		x	x	x	
23.5/51		7+☆1		1	2	x	x	483/19"	133/5.2"	526/20.7"	x	x			x			x	x	x	
15.3/23.5/108			4		2	x	x	483/19"	133/5.2"	526/20.7"	x	x			x		x	x	x	x	
7/23.5/51			3		△1	x	x	483/19"	133/5.2"	526/20.7"	x	x			x			x	x	x	
23.5/51			6	1	2		x	483/19"	133/5.2"	650/25.6"	x	x	x	x		x			x	x	
7/51		2		1	6	x	x	483/19"	133/5.2"	650/25.6"	x	x			x			x	x		
23.5/51			☆1		6	x	x	483/19"	133/5.2"	560/22.1"	x	x			x			x	x		
7/42.5		2			1		x	483/19"	133/5.2"	400/15.7"	x	x			x					x	
23.5/42.5		2		1	1	x	x	483/19"	133/5.2"	400/15.7"	x	x			x			x	x		
7/42.5		1	2	1	△1	x	x	483/19"	133/5.2"	400/15.7"	x	x			x			x	x		
7/23.5			2	1	1	x	x	483/19"	133/5.2"	400/15.7"	x	x			x			x	x		
23.5/90		2+☆1			1	x	x	483/19"	133/5.2"	400/15.7"	x	x						x	x		
15.3/23.5			6		3	x	x	483/19"	133/5.2"	510/20.1"	x	x			x			x	x		
15.3/23.5/51			26(2.5")		1	x	x	483/19"	133/5.2"	650/25.6"	x	x	x	x		x			x	x	
23.5/51		☆2	12	△1	△1	x	x	483/19"	133/5.2"	650/25.6"	x	x	x	x	x	x		x	x		
23.5/51			10	△1	1+△1	x	x	483/19"	133/5.2"	650/25.6"	x	x	x	x	x	x		x	x		
23.5/51			16		△1	x	x	483/19"	133/5.2"	650/25.6"	x	x	x	x	x	x		x	x		
7/23.5/42.5/90		2	4	1	2	x	x	483/19"	177/7.0"	624/24.5"	x	x			x			x	x	x	
23.5/42.5			8	1	2	x	x	483/19"	133/5.2"	610/24.0"	x	x			x			x	x	x	
23.5/51		☆1	8	1	2	x	x	483/19"	133/5.2"	650/25.6"	x	x			x			x	x	x	
23.5/90			6	1	2	x	x	483/19"	133/5.2"	560/22.1"	x	x			x			x	x	x	
23.5/51			16		△1	x	x	483/19"	133/5.2"	650/25.6"	x	x	x	x	x	x		x	x		
7/23.5			3	1	2	x	x	483/19"	133/5.2"	524/20.6"	x	x			x			x	x	x	
7/23.5			3	1	2	x	x	483/19"	133/5.2"	524/20.6"	x	x			x			x	x	x	
42.5		1		1	2	x	x	483/19"	178/7"	427/16.8"	x	x					x		x	x	x
42.5		1		1	2	x	x	483/19"	178/7"	427/16.8"	x	x					x		x	x	x
51				1	3	x	x	483/19"	178/7"	451/17.8"	x	x					x		x	x	x
51				1	3	x	x	483/19"	178/7"	451/17.8"	x	x					x		x	x	x
51				1	3	x	x	483/19"	178/7"	451/17.8"	x	x					x		x	x	x
51				1	3	x	x	483/19"	178/7"	451/17.8"	x	x					x		x	x	x
23.5/51		1			2	x	x	483/19"	177/7"	408/16.1"	x	x					x		x	x	
42.5/90		2			1	x	x	483/19"	177/7.0"	355/14"	x	x					x		x	x	
23.5/51	4				2	x	x	483/19"	177/7"	300/11.9"	x	x					x		x	x	
23.5/51			2		1			483/19"	177/7"	407/16"	x	x					x		x	x	
51				1	3	x	x	483/19"	178/7"	451/17.8"	x	x					x		x	x	x
51				1	3	x	x	483/19"	178/7"	451/17.8"	x	x					x		x	x	x
108		1+☆1			3	x	x	483/19"	178/7"	510/20.1"	x	x					x		x	x	x
108		1+☆1			3	x	x	483/19"	178/7"	510/20.1"	x	x					x		x	x	x
108		☆1		1	4	x	x	483/19"	178/7"	510/20.1"	x	x					x		x	x	x
108		☆1		1	4	x	x	483/19"	178/7"	510/20.1"	x	x					x		x	x	x
108		☆1		1	3	x	x	483/19"	178/7"	510/20.1"	x	x					x		x	x	x
108		☆1		1	3	x	x	483/19"	178/7"	510/20.1"	x	x					x		x	x	x
23.5/51		1			△1	x	x	483/19"	178/7"	490/19.3"	x	x					x		x		
108		☆1		1	3	x	x	483/19"	178/7"	510/20.1"	x	x					x		x	x	x
108		☆1		1	3	x	x	483/19"	178/7"	510/20.1"	x	x					x		x	x	x
32/90		2		1	3	x	x	483/19"	178/7"	510/20.1"	x	x					x		x	x	x
32/90		2		1	3	x	x	483/19"	178/7"	510/20.1"	x	x					x		x	x	x
23.5/51		5		1	2	x	x	483/19"	178/7"	510/20.1"	x	x					x		x	x	x
23.5/51		5+☆1		1	2	x	x	483/19"	178/7"	510/20.1"	x	x					x		x	x	x
42.5/51		☆2		1	3	x	x	480/18.9"	178/7"	671/26.4"	x	x	x	x			x		x	x	x
42.5/51		☆2		1	3	x	x	480/18.9"	178/7"	671/26.4"	x	x	x	x			x		x	x	x
51		1+☆2		1	6	x	x	480/18.9"	178/7"	671/26.4"	x	x	x	x			x		x	x	x
51		1+☆2		1	6	x	x	480/18.9"	178/7"	671/26.4"	x	x	x	x			x		x	x	x
51		2+☆2		1	3	x	x	480/18.9"	178/7"	671/26.4"	x	x	x	x			x		x	x	x
51		2+☆2		1	3	x	x	480/18.9"	178/7"	671/26.4"	x	x	x	x			x		x	x	x
23.5/90		1		1	6	x	x	483/19"	178/7"	573/22.6"	x	x			x			x	x	x	x
90		4		1	8	x	x	483/19"	178/7"	624/24.5"	x	x			x			x	x		
90		4		1	8	x	x	483/19"	178/7"	574/22.5"	x	x			x			x	x		
90					10	x	x	483/19"	178/7"	624/24.5"	x	x			x			x	x		
23.5/90			10		3	x	x	483/19"	177/7"	624/24.5"	x	x			x			x	x		

(F)=Front (H)=Horizontal (V)=Vertical ☆=Optional kit for 3.5" internal Disk Mounting ★= Optional Fan △=For Slim Type Disk

Chassis Comparison Chart

Model	Mounting Configuration options			Board Options		Max. Number of Slots	Power Supply Options		Fan space#				
	Rack	Tower	Wall/ Panel	Passive B/P	M/B		Watts	P/S Type	4 cm	6 cm	8 cm	9 cm	12 cm
GHI-450	x				12"x13"	7	230~700	PS/2 or Mini Redundant					4
GHI-451					12"x13"	7	500~700	PS/2 or Mini Redundant					4
GHI-460	x	x			12"x13"	7	950	3U N+1 Redundant			2	3	
GHI-479	x				12"x13"	14/15	500~700	PS/2 Slinge or Mini Redundant		★2	2		
GHI-480	x				12"x13"	7	950	3U N+1 Redundant		★2			3
GHI-481	x				12"x13"	7	950	3U N+1 Redundant		★2			3
GHI-4F1ATX	x				12"x13"	7	500~700	PS/2 Slinge or Mini Redundant		★2		2	
GHI-4F1SR	x			x		14/15	500~700	PS/2 Slinge or Mini Redundant				2	
GHI-4F2	x				12"x13"	7		3U N+1 Redundant				2	
GHI-M40ATXR	x				12"x10.5"	7	230~700	PS/2 or Mini Redundant		★2		3	
GHI-M40SR	x				12"x10.5"	14	230~700	PS/2 or Mini Redundant				3	
GHI-M41ATXR	x				12"x10.5"	7	230~700	PS/2 or Mini Redundant		★2		3	
GHI-M41SR	x					14	230~700	PS/2 or Mini Redundant				3	
GHI-P02	x				6"x13"		270/ea.	1U Slinge x10	2x10			4	
GH-520SR	x			x		20	300~400	Vertical Redundant(F) or DC 48V				4	★3
GHI-528	x			x		20	1350/1650	1U Redundant			4		
GH-530ATXR	x				12"x16"	7	300~400	Vertical Redundant(F) or DC 48V				4	★3
GHI-580	x				12"x13"	7	500x2	3U N+1 Redundant x2		2	1		3
GHI-581	x				12"x13"	7	500x2	3U N+1 Redundant x2		2	1		3
GHI-583	x				13"x16"	7	1350/1650	1U Redundant		3		4	
GHI-584	x				13"x16"	7	1350/1650	1U Redundant		6			2
GHI-591	x				13"x16"	7	1350/1650	1U Redundant			3		3
GH-600ATXR	x				13"x16"	7	300~700	PS/2 or Horizontal Redundant				4	
GHI-611SR	x			x		20	300~550	PS/2 or Horizontal Redundant				4	
GH-620SR	x			x		20	250~400	PS/2 or Horizontal Redundant				4	
GHI-690	x				13"x16"	7	1350/1650	1U Redundant		5			2
GHI-691	x				13"x16"	7	1350/1650	1U Redundant		5			2
GHI-791-1	x				13"x16"	7	1650	1U Redundant			2	4	2
GHI-791-2	x				13"x16"	7	1650	1U Redundant		3		4	3
GH-800ATXR	x				13"x16"	7	300~400	PS/2 or Horizontal Redundant				4	1
GH-820SR	x			x		20	300~400	PS/2 or Horizontal Redundant				4	1
GHI-891	x				13"x16"	7	1650/950	1U or 3U N+1 Redundant x2		5	1	4	5
GHI-P01	x				12"x13"	1x10	200~460	1U Slinge x10		9x10			
GHB-B01					9.6"x9.6"	4	150~300	1U W=80mm		2			
GHB-B04		x	x	x		4	150	Special				1	
GHB-B05			x			2	200	Flex ATX		1			
GHB-B08	x	x	x	x		8	250~400	PS/2 or Mini Redundant				2	
GHB-030	x			x		3	250~350	1U Single				1	
GHB-042		x	x	x		4	200~300	1U Slinge				1	
GHB-043		x	x	x		4	250~300	1U Single		1		1	
GHB-060		x	x	x		6	230~300	PS/2 or Mini Redundant					1
GHB-061		x	x		9.6"x9.6"	4	250~300	1U Single				1	
GHB-062-6		x	x	x		6	230~300	PS/2 or Mini Redundant					1
GHB-062-8		x	x	x		8	200~350	1U					1
GHB-080		x	x	x		8	230~400	PS/2 or Mini Redundant					1
GHB-081		x	x		12"x10.5"	7	250~500	1U Slinge		★1			1
GHB-082-8		x	x	x		8	200~400	PS/2 or Mini Redundant					1
GHB-082-10		x	x	x		10	200~300	1U Slinge					1
GHB-083-8		x	x	x		8	200~300	1U Single					1
GHB-083-10		x	x	x		10	200~300	1U Single					1
GHB-120ATXR		x	x		9.6"x9.6"	4	230~400	PS/2 or Mini Redundant					1
GHB-120SR		x	x	x		10/12	230~400	PS/2 or Mini Redundant					1
GHC-C01	x				Compact PCI	2	200~400	1U Single	4				
GHC-C02	x				Compact PCI	4	200~400	1U Slinge			2		
GHC-C03	x				Compact PCI	5	300~320	1U Single			1	1	
GHC-C04	x				Compact PCI	7	300~320	1U Slinge			1	2	
GHC-P03	x				Compact PCI	9	300~460	PS/2 or Mini Redundant				2	2+1
GHR-190	x				Storage		400	1U Slinge	6				
GHR-192	x				Storage		300	1U Redundant	6				
GHR-219	x				Storage		250~400	PS/2 or Mini Redundant			4		
GHR-290	x				Storage		250~400	2U Single or Redundant				4	
GHR-390	x				Storage		230~700	PS/2 or Mini Redundant				4+★2	
GHR-422	x				Storage		230~460	PS/2 or Mini Redundant				2+★1	
GHS-1500		x		x	12"x13"	7~14	250~1200	PS/2 or Redundant				5	
GHS-2000		x		x	16"x13"	7~20	250~1200	PS/2 or Redundant				8	2

Chassis Comparison Chart

Chassis Comparison Chart																				
Air Flow	Disk Mounting VD =Vibration Damping					Keyboard Connector		Dimensions (millimeters/inch)			Front Panel Indicator					Front Panel Controls				
CFM/ EACH	2.5" Int	3.5" Int	3.5" H.S.	3.5" F.P.	5.25" F.P.	Front	Rear	Width	Height	Depth	P.S.	HD	Over Heat	Fan Fail	LAN	On/Off	LAN	USB	Reset	Keylock
51		2		Δ1	Δ1		x	431/17"	222/8.7"	557/21.9"	x	x				x			x	x
51		2		Δ1	Δ1		x	431/17"	222/8.7"	557/21.9"	x	x			x	x			x	x
42.5/51			5		3	x	x	483/19"	178/7"	710/28.0"	x	x	x	x	x	x		x	x	
23.5/42.5				2	6	x	x	483/19"	177/7"	510/20.1"	x	x				x		x	x	x
23.5/90	2	☆3	16	Δ1	Δ1	x	x	480/18.9"	178/7"	650/25.6"	x	x	x	x	x	x		x	x	
23.5/90			14	Δ1	1+Δ1	x	x	480/18.9"	178/7"	650/25.6"	x	x	x	x	x	x		x	x	
23.5/51		2		1	Δ1	x	x	483/19"	177/7.0"	447/17.6"	x	x				x		x	x	
51		2		1	Δ1	x		483/19"	177/7.0"	447/17.6"	x	x				x		x	x	
51		2		1	1	x		483/19"	177/7.0"	447/17.6"	x	x				x		x	x	
23.5/51		3	4		Δ1	x	x	483/19"	177/7"	510/20.1"	x	x				x		x	x	x
51		3	4		Δ1	x	x	483/19"	177/7"	510/20.1"	x	x				x		x	x	x
23.5/51		3	4		Δ1	x	x	483/19"	177/7"	510/20.1"	x	x				x		x	x	x
51		3	4		Δ1	x	x	483/19"	177/7"	510/20.1"	x	x				x		x	x	x
15/52	2x10					x		483/19"	177/7"	650/25.6"	x	x				x	x	x	x	
51/90				1	4		x	483/19"	222/8.7"	671/26.4"	x	x	x	x		x			x	x
42.5				1	8		x	483/19"	222/8.7"	671/26.4"	x	x	x	x		x			x	
51/90				1	4		x	483/19"	222/8.7"	671/26.4"	x	x	x	x		x			x	x
23.5/42.5/90	2	☆2	24	Δ1	Δ1	x	x	483/19"	222/8.7"	650/25.6"	x	x	x	x	x	x		x	x	
23.5/42.5/90	2	☆2	22	Δ1	Δ1	x	x	483/19"	222/8.7"	650/25.6"	x	x	x	x	x	x		x	x	
23.5/51	2	☆2	24	Δ1	Δ1	x	x	483/19"	222/8.7"	650/25.6"	x	x	x	x	x	x		x	x	
23.5/90	2	☆2	24	Δ1	Δ1	x	x	483/19"	222/8.7"	650/25.6"	x	x	x	x	x	x		x	x	
42.5/90	1	☆3	22	1	1	x	x	483/19"	222/8.7"	650/25.6"	x	x	x	x	x	x		x	x	
51				1	7		x	483/19"	267/10.5"	671/26.4"	x	x	x	x		x			x	x
51		1		1	4	x	x	483/19"	267/10.5"	671/26.4"	x	x	x	x		x		x	x	x
51				1	7		x	483/19"	267/10.5"	671/26.4"	x	x	x	x		x			x	x
23.5/108			36	Δ1	Δ1	x	x	483/19"	267/10.5"	671/26.4"	x	x	x	x	x	x			x	
23.5/108			32	Δ1	Δ1	x	x	483/19"	267/10.5"	671/26.4"	x	x	x	x	x	x		x	x	
42.5/51/90			36	Δ1	Δ1	x	x	483/19"	311/12.2"	666/26.2"	x	x	x	x	x	x		x	x	
23.5/51/90			36	Δ1	Δ1	x	x	483/19"	311/12.2"	666/26.2"	x	x	x	x	x	x		x	x	
51/108				1	7		x	483/19"	356/14"	510/20.1"	x	x	x	x		x			x	x
51/108				1	7		x	483/19"	356/14"	510/20.1"	x	x	x	x		x			x	x
23.5/42.5/51/90			40	Δ1	Δ1	x	x	483/19"	354/13.9"	666/26.2"	x	x	x	x	x	x	x	x	x	
8/15		2x10				x		483/19"	356/14"	830/32.7"	x	x				x	x		x	
23.5	2				Δ1	x	x	350/13.8"	89/3.5"	337/13.3"	x	x				x		x	x	
51		1		1		x	x	110/4.3"	267/10.5"	450/17.7"	x	x				x		x	x	
23.5	4				Δ1	x	x	280/11.0"	77.0/3.0"	268/10.6"	x	x				x		x	x	
51		1		1	1	x	x	220/8.7"	267/10.5"	450/17.7"	x	x				x		x	x	
51		1				x	x	110/4.3"	221.5/8.7"	250/9.8"	x	x				x		x	x	
51		1		1		x	x	110/4.3"	267/10.5"	450/17.7"	x	x				x		x	x	
23.5/51		1		1	Δ1	x	x	160/6.3"	220/8.6"	260/10.2"	x	x				x		x	x	
90		1+☆1		1	1	x	x	307/12.1"	177/7"	420/16.5"	x	x	x	x		x			x	
51		1+☆1		1	1	x	x	307/12.1"	177/7"	420/16.5"	x	x	x	x		x		x	x	
90		1+☆1		1	1	x	x	307/12.1"	177/7"	420/16.5"	x	x	x	x		x		x	x	
90		1+☆1		1	1	x	x	307/12.1"	177/7"	420/16.5"	x	x	x	x		x		x	x	
90		1		1	2	x	x	350/13.8"	177/7"	420/16.5"	x	x	x	x		x		x	x	
90			1	1	2			350/13.8"	177/7"	411/16.2"	x	x	x	x	x	x		x	x	
90		1		1	2	x	x	350/13.8"	177/7"	411/16.1"	x	x	x	x		x		x	x	
90		1		1	2	x	x	350/13.8"	177/7"	411/16.1"	x	x	x	x		x		x	x	
90		1		1	1	x	x	280/11"	237/9.3"	260/10.2"	x	x			x		x	x	x	
90		1		1	1	x	x	280/11"	237/9.3"	260/10.2"	x	x			x		x	x	x	
90		1		2	2	x	x	400/15.7"	177/7"	420/16.5"	x	x	x	x		x		x	x	
90		1		2	2	x	x	400/15.7"	177/7"	420/16.5"	x	x	x	x		x		x	x	
10.8								483/19"	44/1.7"	323/12.7"	x	x				x			x	
42.5			1					483/19"	88/3.5"	296/11.7"	x	x				x			x	
42.5/51			1	Δ1	Δ1			483/19"	133/5.2"	296/11.7"	x	x				x			x	
42.5/51			2	Δ1	Δ1			483/19"	178/7"	296/11.7"	x	x				x			x	
32.5/51/90				1	3			483/19"	355/14"	365/14.4"	x	x				x			x	
15.3			4					483/19"	44/1.7"	450/17.7"	x	x	x	x		x			x	
15.3			4					483/19"	44/1.7"	610/24.0"	x	x	x	x		x			x	
42.5			9					483/19"	88/3.5"	450/17.7"	x	x	x	x		x			x	
42.5			12					483/19"	88/3.5"	650/25.6"	x	x	x	x		x			x	
51			15					483/19"	88/3.5"	507/20.0"	x	x	x	x		x			x	
51					9			483/19"	177/7"	510/20.1"	x	x	x	x		x			x	
51					15		x	410/16.2"	416/16.4"	710/28"	x	x	x	x		x			x	x
51/108					23		x	410/16.2"	600/23.6"	710/28"	x	x	x	x		x			x	x

(F)=Front (H)=Horizontal (V)=Vertical ☆=Optional kit for 3.5" internal Disk Mounting ★= Optional Fan Δ=For Slim Type Disk

GHI-100/101

1U Rackmount Chassis



Specifications

- **EIA RS-310C 19" Rackmount Standard**
- **Construction:** Heavy Duty Cold Rolled Electroplated Steel
- **Color:** Black (standard), Beige or Custom
- **System Boards:** 2 slot (GHI-100) or 3 slot (GHI-101)
Passive Backplane
- **Drive Capacity:** (Option A): 1x Slim CD-ROM, 3.5" HDD, & 1x Slim FDD, 3.5" HDD & 1x2.5"HDD(Optional)
(Option B): 1x 5.25" & 1x 3.5" & 1x 2.5"HDD(Optional)
- **Power Supply(Optional):** 1U Single up to 350W ATX P/S (Rear Installation) Max. Depth 205mm
- **Cooling:** 3x (40x20mm = 7CFM ea.) Fans
- **Front Door:** Single Door with 2 Thumbscrews
- **Connector Port (Front):** 2x USB & 1x PS/2 Ports
- **Indicators:** LEDs for Power ON/OFF, HDD Activity
- **Switch:** Power ON/OFF Momentary (Rocker), System Reset
- **Dimensions (WxHxD):** 483 x 44 x 450mm (19" x 1.7" x 17.7")
- **Cuft:** 2.3
- **GW:** 10.0 kgs / 22.1 lbs
- **Carton Size(cm):** 61.5 x 17.9 x 60 (24.2" x 7" x 23.6")
- **Humidity:** 5% - 95% Non-condensing

Dimension

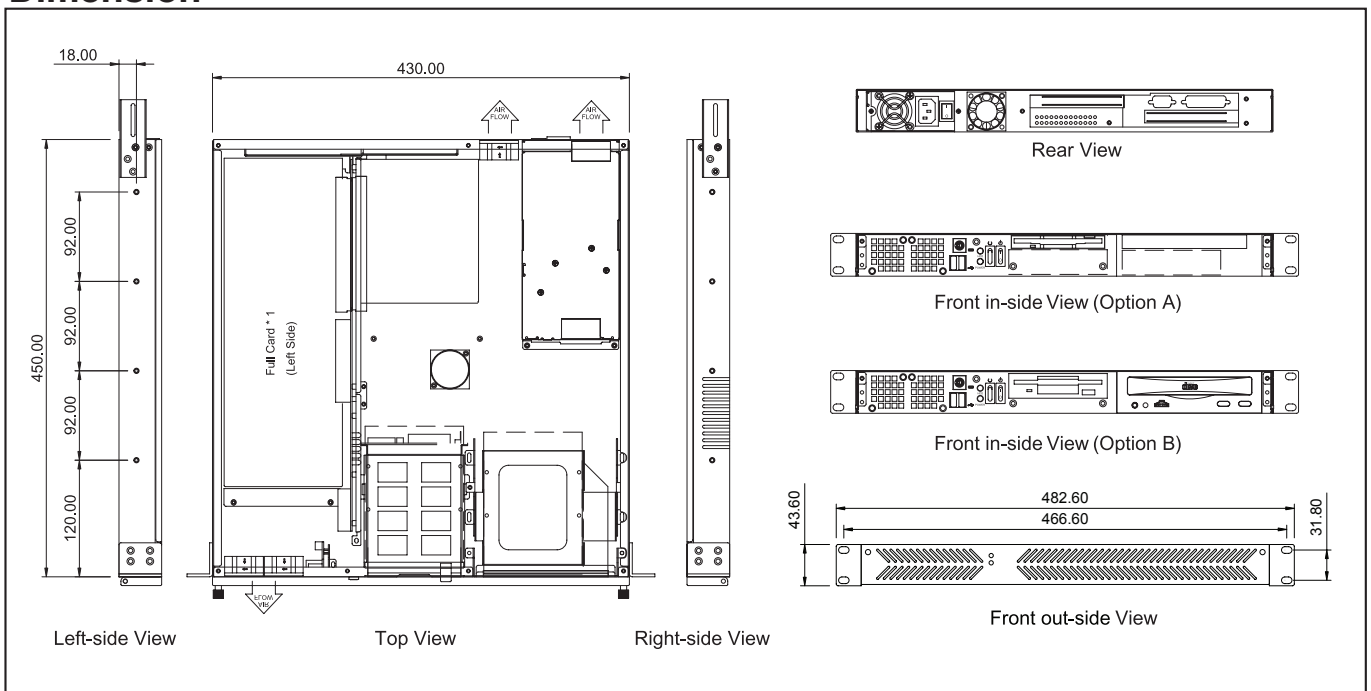

GHI-104/104DX

1U Rackmount Chassis



19" Rackmount

Specifications

- **EIA RS-310C 19" Rackmount Standard**
- **Construction:** Heavy Duty Cold Rolled Electroplated Steel
- **Color:** Black (Standard), Beige or Custom
- **System Boards:** Dual Xeon, Pentium 4, Athlon 64, Dual Operton
- **Support EATX M/B (12"x 13") SSI EEB 3.0**
- **Drive Capacity:**
(Option A): 1x 5.25" & 1x 3.5" & 2x 3.5"HDD
(Option B): 2x 5.25" & 1x 3.5"
- **Power Supply(Optional):** 1U Single up to 500W ATX P/S(Mid Installation) Max. Depth 225mm
- **Cooling:** 3x(40 x 20mm) Fans(7.0CFM ea.) & 2x (40 x 28mm) Fans(15.3CFM ea.)(GHI-104) or 5x (40 x 28mm = 15.3CFM ea.) Fans (GHI-104DX)
- **Front Door:** Single Door with 1 Thumbscrew
- **Riser Card:** Please Check Page 193-194 For Optional 1U Riser Card
- **Connector Port(Front):** 2x USB Ports
- **Expansion Slots:** 1x Horizontal PCI Slot
- **Indicators:** LEDs for Power ON/OFF, HDD Activity
- **Switch:** Power ON/OFF, System Reset
- **Dimensions (WxHxD):** 483x44x605mm(19" x 1.7" x 23.8")
- **Cuft:** 2.8
- **GW:** 10.0kgs / 22.1lbs
- **Carton Size(cm):** 74.5 x 18.5 x 57.3 (29.3" x 7.3" x 22.6")
- **Humidity:** 5% - 95% Non-condensing

Dimension

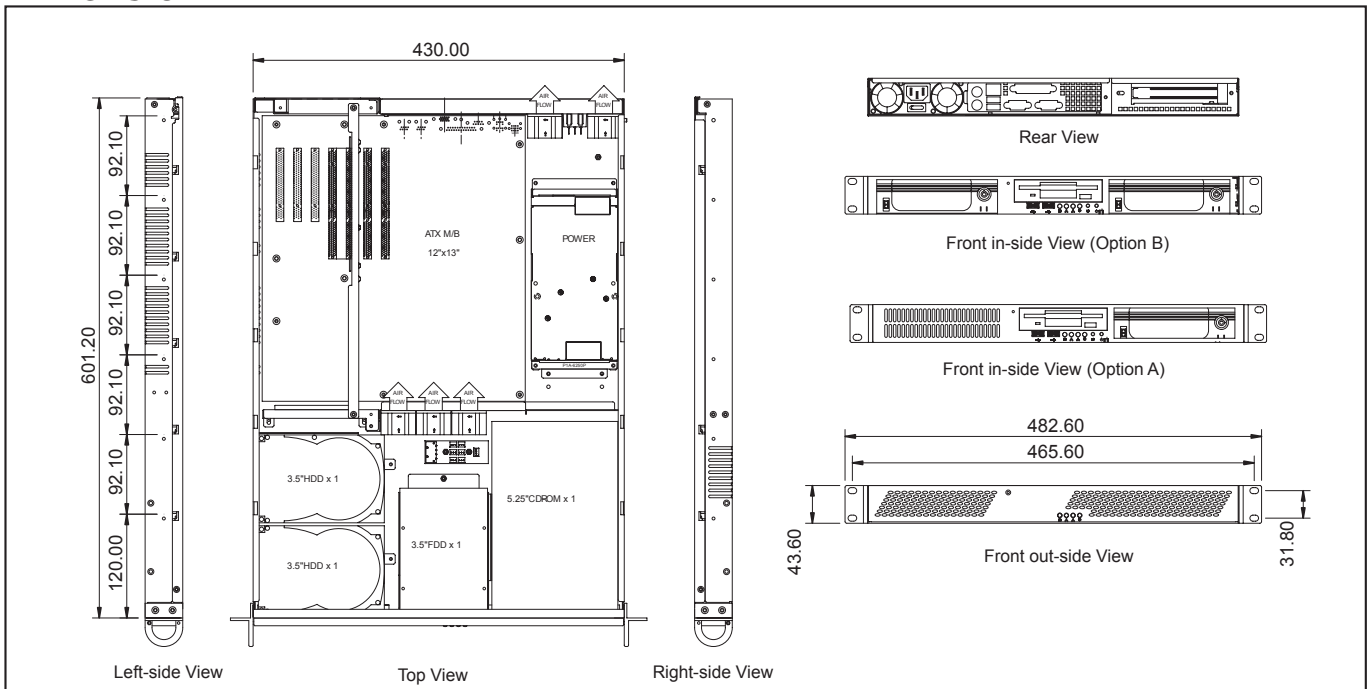

GHI-105/105DX

1U Rackmount Chassis



Specifications

- **EIA RS-310C 19" Rackmount Standard**
- **Construction:** Heavy Duty Cold Rolled Electroplated Steel
- **Color:** Black (Standard), Beige or Custom
- **System Boards:** Dual Xeon, Pentium 4, Athlon 64, Opteron
- **Support ATX M/B (Max. to 12" x 10.5")**
- **Drive Capacity:**
 (Option A): 1x 5.25" & 1x 3.5" & 2x 3.5" HDD
 (Option B): 2x 5.25" & 1x 3.5"
- **Power Supply(Optional):** 1U Single up to 500W ATX P/S(Mid Installation) Max. Depth 215mm
- **Cooling:** 3x (40 x 20mm = 7CFM ea.) & 2x (40 x 28mm = 15.3CFM ea.) Fans (GHI-105), or 5x(40 x 28mm = 15.3CFM ea.) Fans (GHI-105DX), Extra 2x40mm Mid Installation Fans (Optional)
- **Front Door:** Single Door with 1 Thumbscrew
- **Riser Card:** Please Check Page 193-194 For Optional 1U Riser Card
- **Connector Port(Front):** 2x USB Ports
- **Expansion Slots:** 1x Horizontal PCI Slot
- **Indicators:** LEDs for Power ON/OFF, HDD Activity
- **Switch:** Power ON/OFF, System Reset
- **Dimensions(WxHxD):** 483x44x542mm (19" x 1.7" x 21.3")
- **Cuft:** 2.6
- **GW:** 10.1 kgs / 22.3 lbs
- **Carton Size(cm):** 68.5 x 18.5 x 57.3 (27" x 7.3" x 22.6")
- **Humidity:** 5% - 95% Non-condensing

Dimension

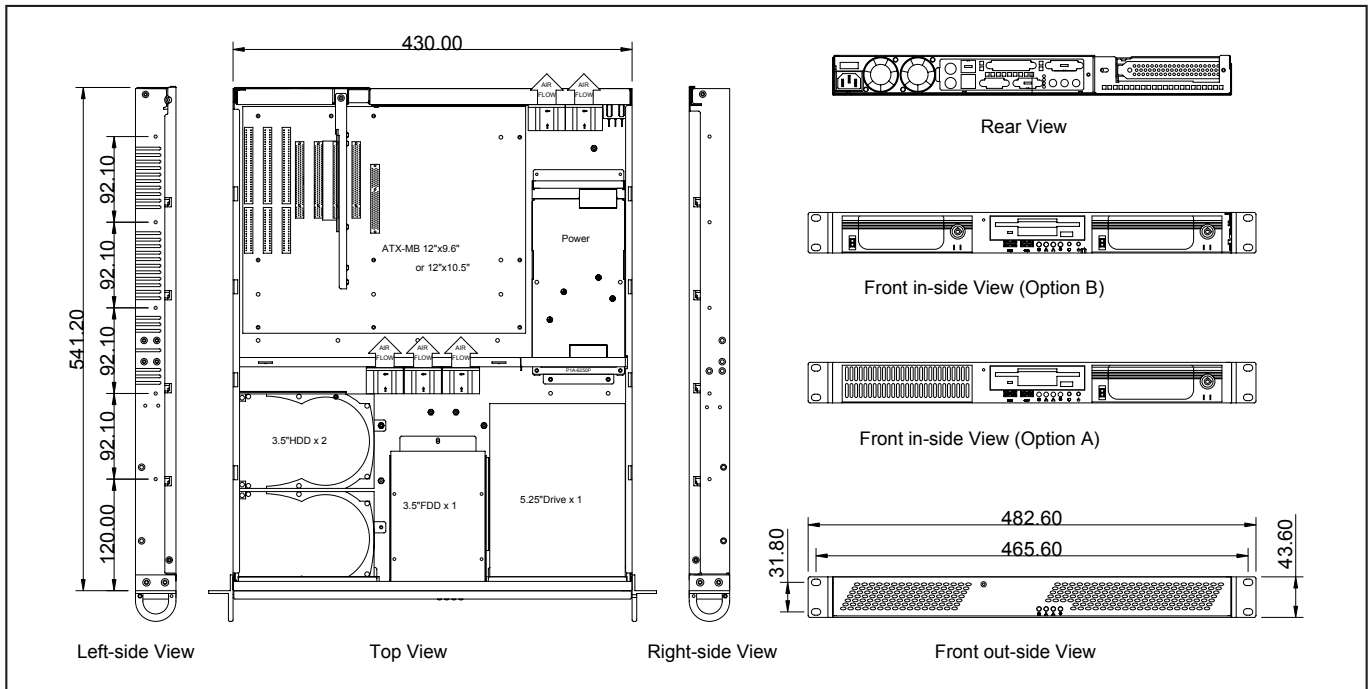

GHI-106

1U Rackmount Chassis



Specifications

- **EIA RS-310C 19" Rackmount Standard**
- **Construction:** Heavy Duty Cold Rolled Electroplated Steel
- **Color:** Black (Standard), Beige or Custom
- **Support Mini-ITX M/B (Max. to 6.7" x 6.7")**
- **Drive Capacity:**
(Option A): 1x Slim CD-ROM, 1x Slim FDD, 1x 2.5"HDD
(Option B): 1x Slim CD-ROM, 1x 3.5" HDD
- **Power Supply(Optional):** 1U Single 200W ATX P/S(Rear Installation) Max. Depth 150mm
- **Cooling:** 2 x (40 x 20mm = 7CFM ea) Fans (Optional)
- **Riser Card:** Please Check Page 193-194 For Optional 1U Riser Card
- **Connector Port(Front):** 2x USB Ports
- **Indicators:** LEDs for Power ON/OFF, HDD Activity
- **Switch:** Power ON/OFF Momentary (Square), System Reset
- **Dimensions (WxHxD):** 483 x 43 x 220mm(19" x 1.7" x 8.7")
- **Cuft:** 1.3
- **GW:** 3.8 kgs / 8.4 lbs
- **Carton Size(cm):** 57.3 x 18.5 x 35.5 (22.6" x 7.3" x 14")
- **Humidity :** 5% - 95% Non-condensing

Dimension

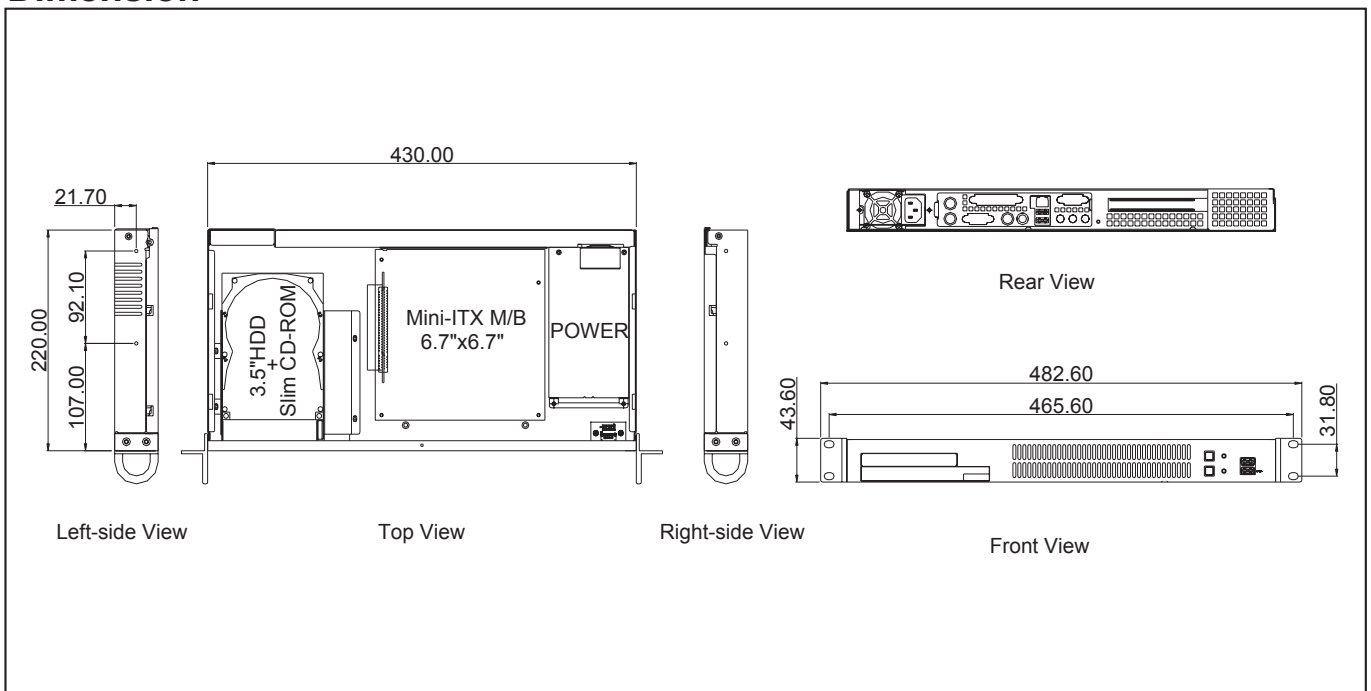

GHI-107

1U Rackmount Chassis



Specifications

- **EIA RS-310C 19" Rackmount Standard**
- **Construction:** Heavy Duty Cold Rolled Electroplated Steel
- **Color:** Black (Standard), Beige or Custom
- **System Boards:** Dual Xeon, Dual Opteron, Pentium 4, Dual Pentium III
- **Support ATX M/B (Max. to 12" x 9.6") SSI EEB 3.0**
- **Drive Capacity:** 2x 3.5" HDD
- **Power Supply(Optional):** 1U 250~400W ATX P/S, Max. Depth 190mm
- **Changeable Front and Rear Rackmount**
- **Cooling:** 2x (40 x 28mm = 15.3CFM ea.) Fans
- **Riser Card:** Please Check Page 193-194 For Optional 1U Riser Card
- **Expansion Slots:** 1x Horizontal PCI Slot
- **Indicators:** LEDs for Power ON/OFF, HDD Activity
- **Switch:** Power ON/OFF, System Reset
- **Dimensions (W x H x D):** 483 x 44 x 382mm (19" x 1.7" x 15")
- **Cuft:** 2.0
- **GW:** 7.6 kgs / 16.8 lbs
- **Carton Size(cm):** 53.5 x 18 x 58.3 (21.1" x 7.1" x 23")
- **Humidity:** 5% - 95% Non-condensing

Dimension

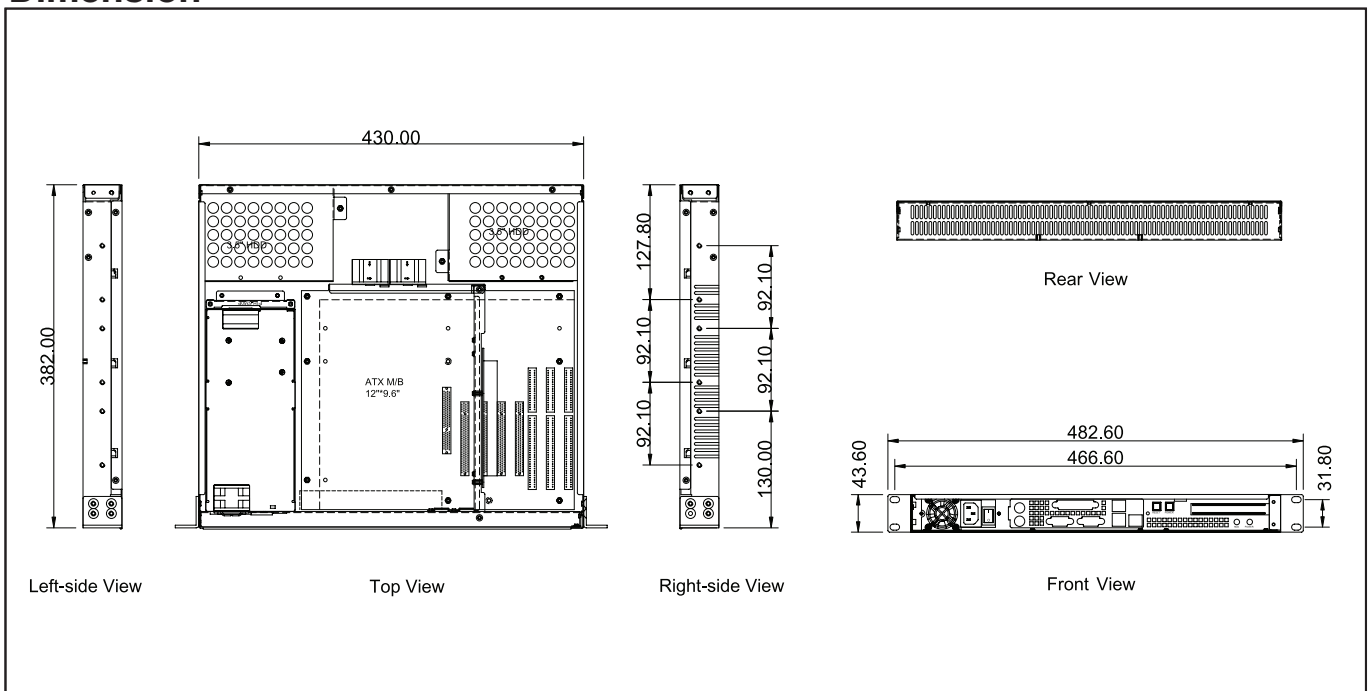

GHI-107A

1U Rackmount Chassis



19" Rackmount

Specifications

- **EIA RS-310C 19" Rackmount Standard**
- **Construction:** Heavy Duty Cold Rolled Electroplated Steel
- **Color:** Black (Standard), Beige or Custom
- **System Boards:** Dual Xeon, Dual Operton, Pentium 4, Dual Pentium III
- **Support ATX M/B (Max. to 12" x 10.5")**
- **Changeable Front and Rear Rackmount**
- **Drive Capacity:** 1x Slim CD-ROM & 1x 2.5" HDD (for 12" x 10.5" M/B) or 1x 3.5" HDD (for 12" x 9.6" M/B)
- **Power Supply(Optional):** 1U up to 400W ATX P/S, Max. Depth 190mm
- **Cooling:** 3x (40x28mm = 15.3CFM ea.) Fans
- **Riser Card:** Please Check Page 193-194 For Optional 1U Riser Card
- **Connector Port(Front):** 2x USB Ports
- **Expansion Slots:** 1x Horizontal PCI Slot
- **Indicators:** LEDs for Power ON/OFF, HDD Activity
- **Switch:** Power ON/OFF, System Reset
- **Dimensions (W x H x D):** 483 x 44 x 386mm (19" x 1.7" x 15.2")
- **Cuft:** 2.1
- **GW:** 7.3 kgs / 16.1 lbs
- **Carton Size(cm):** 52 x 19 x 59 (20.5" x 7.5" x 23.2")
- **Humidity:** 5% - 95% Non-condensing

Dimension

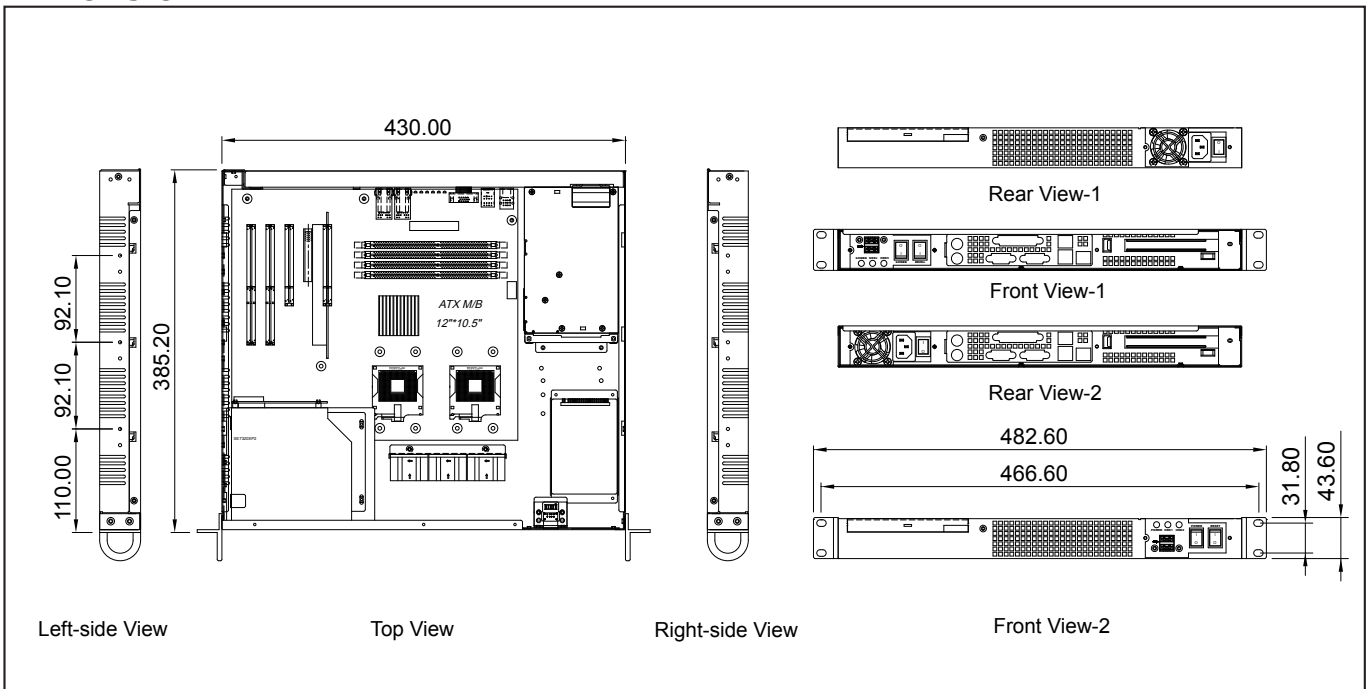

GHI-108

1U Rackmount Chassis



Specifications

- **EIA RS-310C 19" Rackmount Standard**
- **Construction:** Heavy Duty Cold Rolled Electroplated Steel
- **Color:** Black (Standard), Beige or Custom
- **Support Mini-ITX M/B (Max. to 6.7" X 6.7")**
- **Drive Capacity:** 1x Slim CD-ROM & 1x 3.5" HDD & 1x 2.5" HDD
- **Power Supply(Optional):** 1U Single up to 200W ATX P/S(Rear Installation) Max. Depth 150mm
- **Cooling:** 3x (40 x 20mm=7CFM ea.) Fans & 1x (40 x 20mm=7CFM ea.) Fan (Optional)
- **Riser Card:** Please Check Page 193-194 For Optional 1U Riser Card
- **Extension Port(Front):** 2x USB Ports
- **Indicators:** LEDs for Power ON/OFF, HDD Activity
- **Switch:** Power ON/OFF Momentary (Square), System Reset
- **Dimensions (W x H x D):** 483 x 44 x 300mm (19" x 1.7" x 11.8")
- **Cuft:** 1.3
- **GW:** 6.2 kgs / 13.7 lbs
- **Carton Size(cm):** 43 x 15.4 x 56 (16.9" x 6.1" x 22")
- **Humidity :** 5% - 95% Non-condensing

Dimension

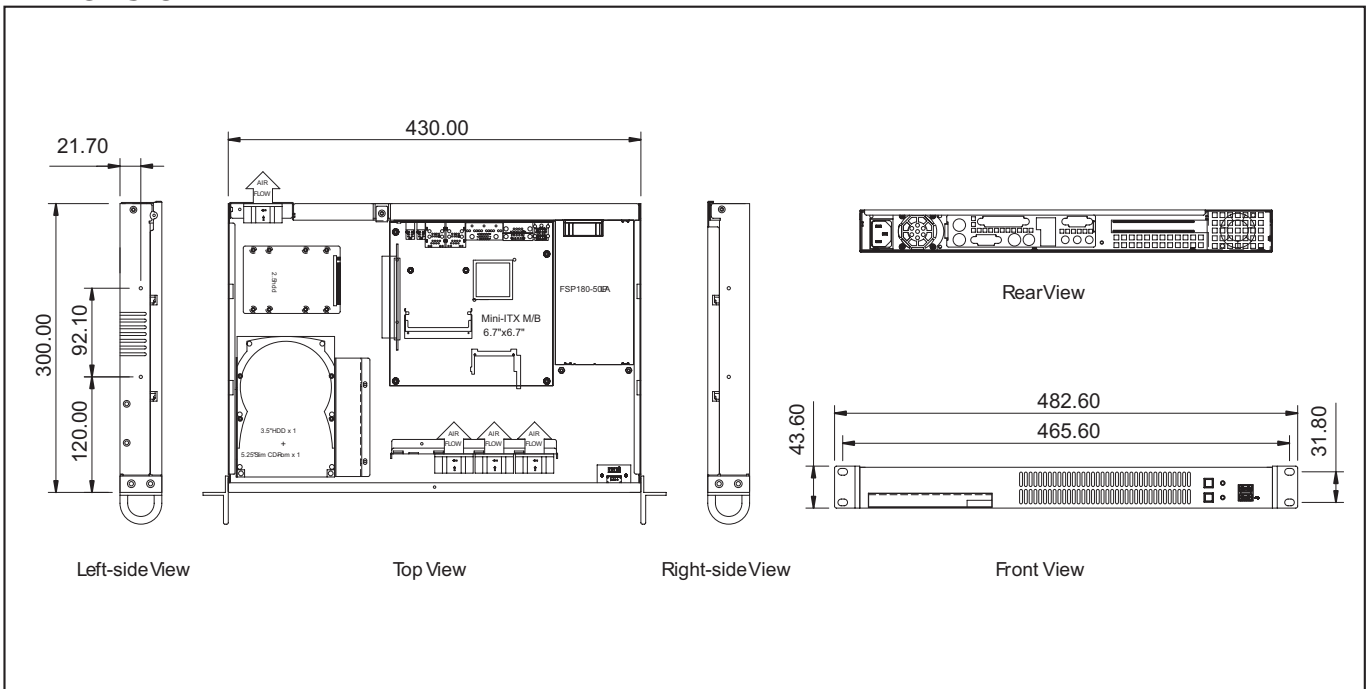

GHI-109

1U Rackmount Fanless Chassis



Specifications

- **EIA RS-310C 19" Rackmount Standard**
- **Construction:** Heavy Duty Cold Rolled Electroplated Steel
- **Color:** Black (Standard), Beige or Custom
- **Support Mini-ITX M/B (6.7" x 6.7")**
- **Drive Capacity:** 1x Slim CD-ROM & 1x 3.5"HDD & 1x 2.5"HDD
- **Power Supply(Optional):** 1U up to 400W ATX P/S, (Rear Installation) Max. Depth 190mm
- **Cooling:** With Heat Sink and Heat Pipe (for CPU and Chip) Fanless Designed
- **Connector Port(Front):** 2x USB Ports
- **Riser Card:** Please Check Page 193-194 For Optional 1U Riser Card
- **Expansion Slots:** 1x Horizontal PCI Slot
- **Indicators:** LEDs for Power ON/OFF, HDD Activity
- **Switch:** Power ON/OFF, System Reset
- **Dimensions (W x H x D):** 483 x 44 x 302mm (19" x 1.7" x 11.9")
- **Cuft:** 1.3
- **GW:** 6.9 kgs / 15.2 lbs
- **Carton Size(cm):** 43 x 15.4 x 56 (16.9" x 6.1" x 22")
- **Humidity:** 5% - 95% Non-condensing

Dimension

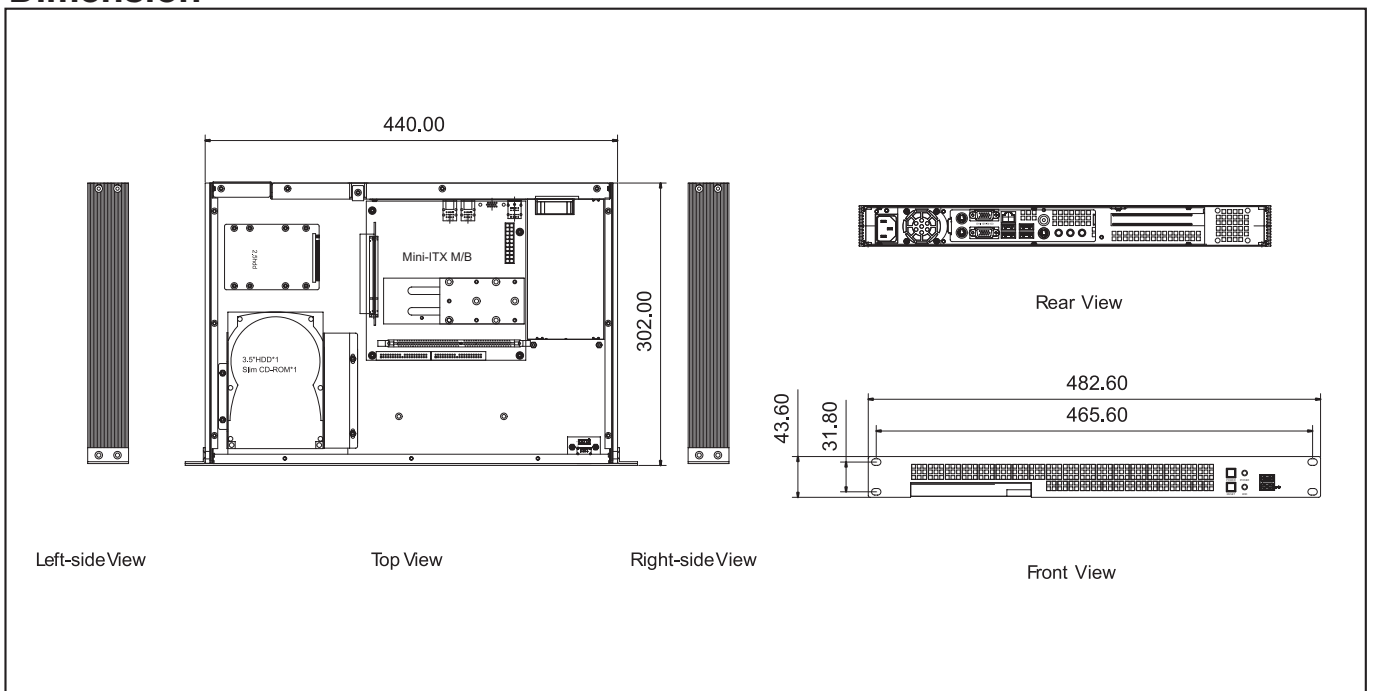

GHI-110

1U Rackmount Chassis



Specifications

- **EIA RS-310C 19" Rackmount Standard**
- **Construction:** Heavy Duty Cold Rolled Electroplated Steel
- **Color:** Black (Standard), Beige or Custom
- **System Boards:** Pentium 4
- **Support ATX M/B (Max. to 12" x 9.6")**
- **Drive Capacity:** (Option A): 1x Slim CD-ROM, 3.5"HDD & 1x Slim FDD, 3.5"HDD & 1x 3.5"HDD
(Option B): 1x5.25" & 1x3.5"FDD & 1x3.5"HDD
- **Power Supply(Optional):** 1U Single up to 350W ATX P/S(Rear Installation) Max. Depth 205mm
- **Cooling:** 2x (40 x 20mm = 7CFM ea.) & 3x (40 x 10mm) Fans
- **Front Door:** Single Door With 2 Thumbscrews
- **Riser Card:** Please Check Page 193-194 For Optional 1U Riser Card
- **Connector Port(Front):** 2x USB Ports
- **Expansion Slots:** 1x Horizontal PCI Slot
- **Indicators:** LEDs for Power ON/OFF, HDD Activity
- **Switch:** Power ON/OFF Momentary (Rocker), System Reset
- **Dimensions (WxHxD):** 483 x 44 x 450mm (19" x 1.7" x 17.7")
- **Cuft:** 2.3
- **GW:** 10.0kgs / 22.1lbs
- **Carton Size(cm):** 61.5 x 17.9 x 60 (24.2" x 7.1" x 23.6")
- **Humidity :** 5% - 95% Non-condensing

Dimension

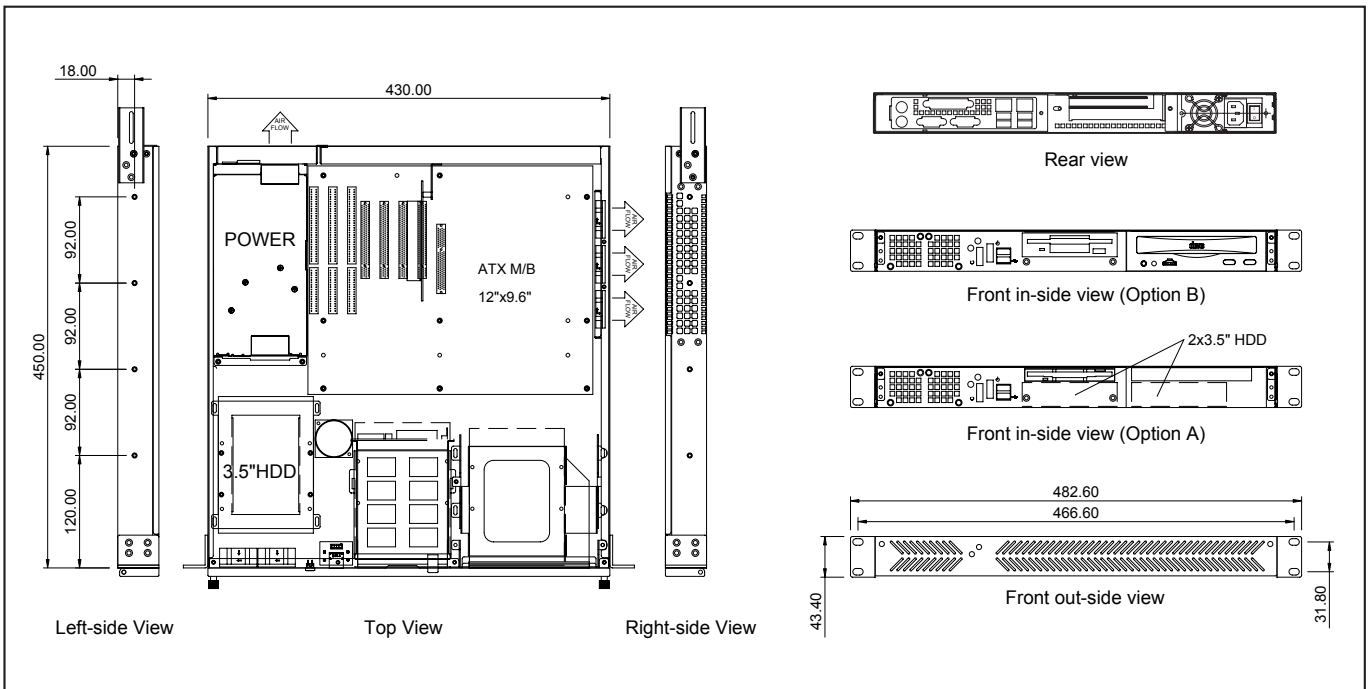

GHI-112

1U Rackmount Chassis



Specifications

- **EIA RS-310C 19" Rackmount Standard**
- **Construction:** Heavy Duty Cold Rolled Electroplated Steel
- **Color:** Black (Standard), Beige or Custom
- **System Boards:** Pentium 4, Dual Xeon, Athlon 64, Opteron
- **Support ATX M/B (Max. to 12" x 9.6")**
- **Drive Capacity:** 1x Slim CD-ROM & 1x Slim FDD & 1x 3.5"HDD
- **Power Supply(Optional):** 1U Single up to 350W ATX P/S (Rear Installation) Max. Depth 205mm
- **Cooling:** 3x (40 x 28mm = 15.3CFM ea.) Fans
- **Connector Port(Front):** 2x USB Ports
- **Front Door:** Single Door With 1 Thumbscrew
- **Riser Card:** Please Check Page 193-194 For Optional 1U Riser Card
- **Expansion Slots:** 1x Horizontal PCI Slot
- **Indicators:** LEDs for Power ON/OFF, HDD Activity
- **Switch:** Power ON/OFF Momentary (Oval), System Reset
- **Dimensions (W x H x D):** 483 x 44 x 407mm (19" x 1.7" x 16")
- **Cuft:** 2.1
- **GW:** 8.1 kgs / 17.9 lbs
- **Carton Size(cm):** 58 x 18.5 x 55.5 (22.8" x 7.3" x 21.9")
- **Humidity :** 5% - 95% Non-condensing

Dimension

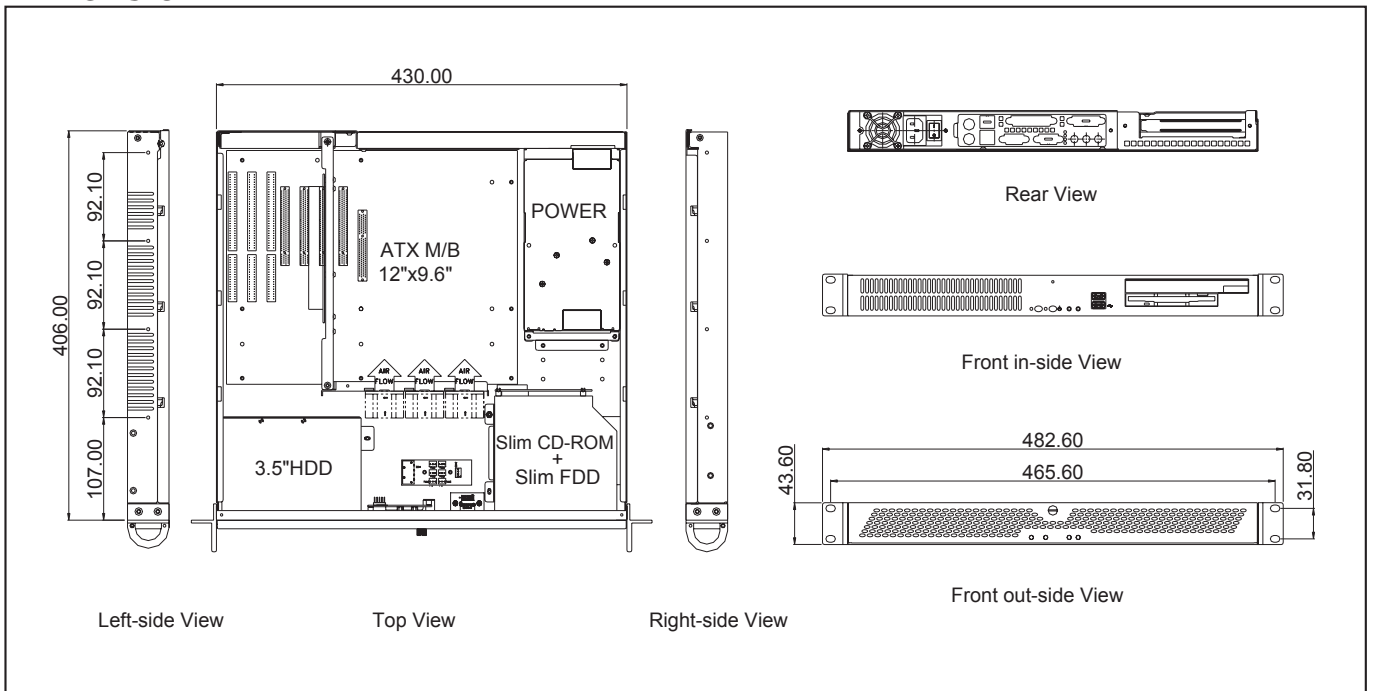

GHI-113

1U Rackmount Chassis



Specifications

- **EIA RS-310C 19" Rackmount Standard**
- **Construction:** Heavy Duty Cold Rolled Electroplated Steel
- **Color:** Black (Standard), Beige or Custom
- **System Boards:** Dual Xeon, Pentium 4, Athlon 64, Dual Opteron
- **Support EATX M/B (Max. to 12" x 13") SSI EEB 3.0**
- **Drive Capacity:**
 (Option A): 1x 5.25", 1x 3.5" Open & 1x 3.5" Swappable Tray
 (Option B): 1x 5.25" & 2x 3.5" Swappable Trays
- **Drive Interface:** PATA, SATA, SCSI320 or SAS
- **Power Supply(Optional):** 1U Single up to 500W ATX P/S(Mid Installation) Max. Depth 250mm
- **Cooling:** 7x (40 x 28mm = 15.3CFM ea.) Fans
- **Front Door:** Single Door with 1 Thumbscrew
- **Riser Card:** Please Check Page 193-194 For Optional 1U Riser Card
- **Expansion Slots:** 1x Horizontal PCI Slot
- **Indicators:** LEDs for Power ON/OFF, HDD Activity
- **Switch:** Power ON/OFF Momentary (Square), System Reset
- **Dimensions (WxHxD):** 483 x 44 x 650mm (19" x 1.7" x 25.6")
- **Cuft:** 3.1
- **GW:** 14.5kgs / 32lbs
- **Carton Size(cm):** 59.4 x 18.2 x 81.8 (23.4" x 7.2" x 32.2")
- **Humidity:** 5% - 95% Non-condensing

Dimension

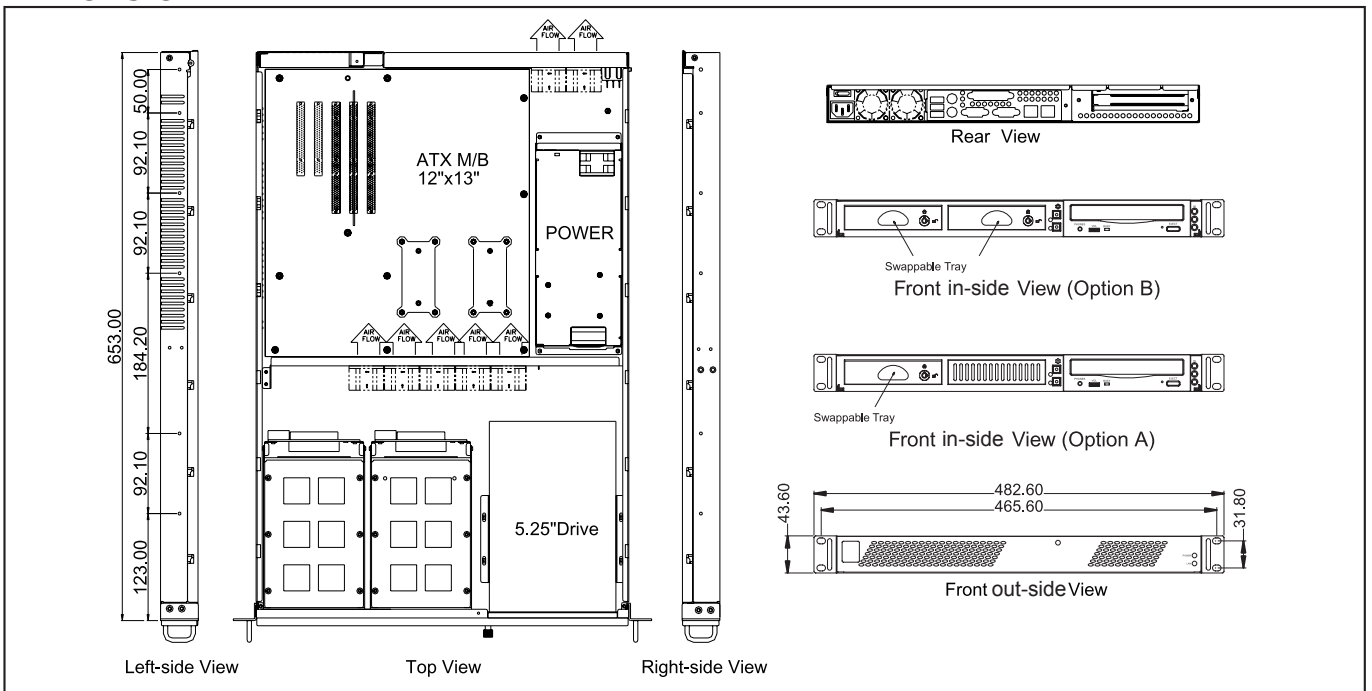

GHI-114

1U Rackmount Chassis



19" Rackmount

Specifications

- **EIA RS-310C 19" Rackmount Standard**
- **Construction:** Heavy Duty Cold Rolled Electroplated Steel
- **Color:** Black (Standard), Beige or Custom
- **System Boards:** Dual Xeon, Pentium 4, Athlon 64, Dual Opteron
- **Support EATX M/B (Max. to 12" x 13") SSI EEB 3.0**
- **Drive Capacity:** 1x Slim CD-ROM & 1x Slim FDD & 1x 3.5" HDD
- **Power Supply(Optional):** 1U Single up to 500W ATX P/S(Mid Installation) Max. Depth 225mm
- **Cooling:** 6x (40 x 28mm = 15.3CFM ea.) Fans
- **Front Door:** Single Door With 1 Thumbscrew
- **Riser Card:** Please Check Page 193-194 For Optional 1U Riser Card
- **Connector Port(Front):** 2x USB Ports
- **Expansion Slots:** 1xHorizontal PCI Slot
- **Indicators:** LEDs for Power ON/OFF, LAN, HDD Activity
- **Switch:** Power ON/OFF Momentary (Oval), System Reset
- **Dimensions (WxHxD):** 483 x 44 x 543mm (19" x 1.7" x 21.4")
- **Cuft:** 2.5
- **GW:** 10.2 kgs / 22.5 lbs
- **Carton Size(cm):** 67.1 x 18.5 x 56 (26.4" x 7.3" x 22.1")
- **Humidity:** 5% - 95% Non-condensing

Dimension

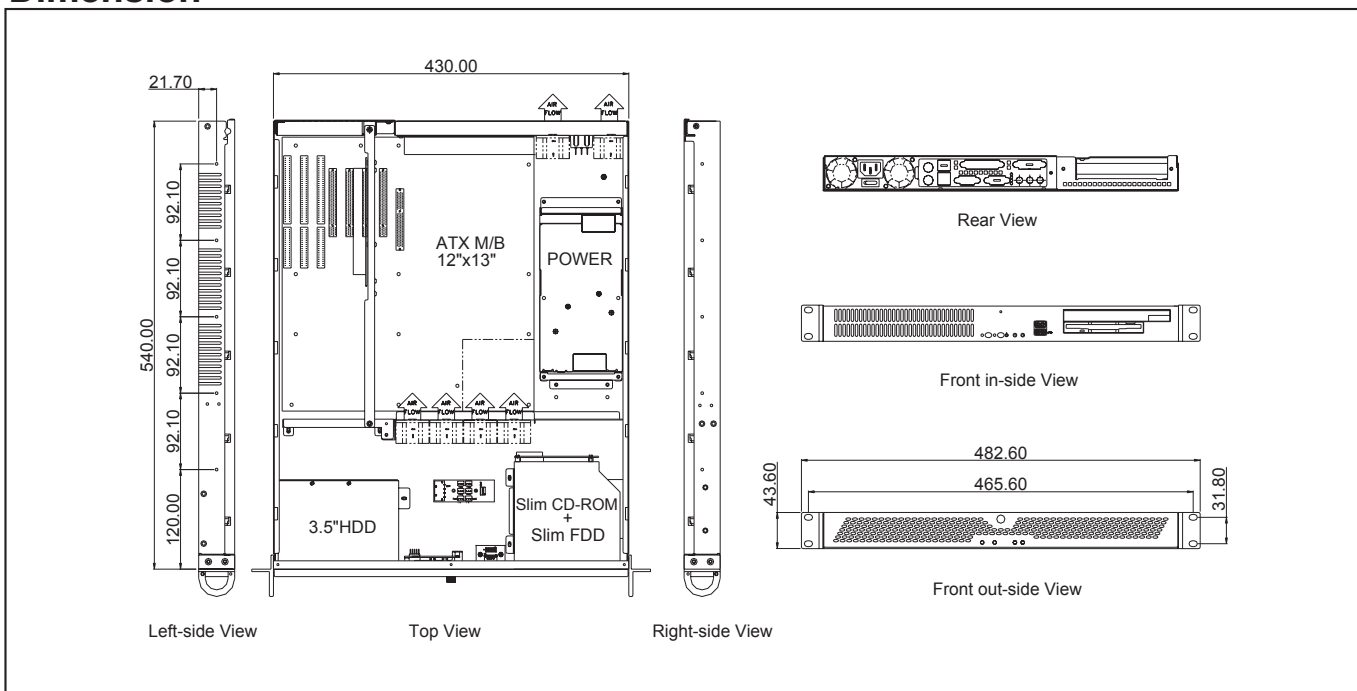

GHI-142

1U Rackmount Chassis

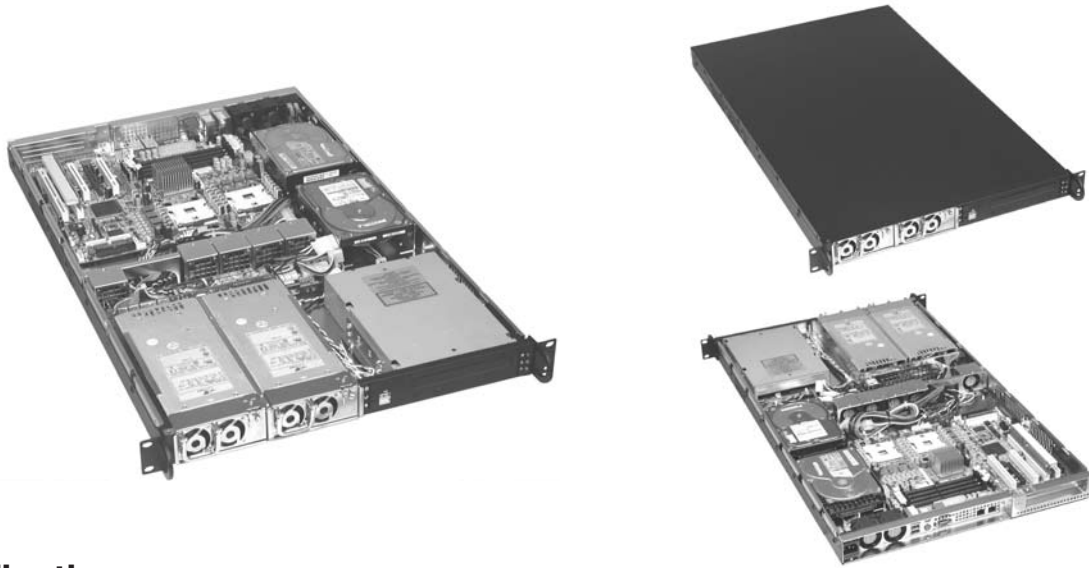

Specifications

- **EIA RS-310C 19" Rackmount Standard**
- **Construction:** Heavy Duty Cold Rolled Electroplated Steel
- **Color:** Black (Standard), Beige or Custom
- **Support EATX M/B (Max. to 12" x 13")**
- **Drive Capacity:** 1x Slim CD-ROM & 1x Slim FDD (or 1x5.25" CD-ROM) & 2x 3.5" HDD
- **Power Supply(Optional):** 1U Redundant up to 400W ATX P/S(Front Installation)
- **Cooling:** 7x (40x28 mm = 15.3CFM ea.) Fans
- **Connector Port(Front):** 2x USB Ports
- **Riser Card:** Please Check Page 193-194 For Optional 1U Riser Card
- **Expansion Slots:** 1x Horizontal PCI Slot
- **Thermal Management Card:** GHA-CO04
- **Indicators:** LEDs for Power ON/OFF, LAN, HDD Activity, Fans, Temperature
- **Switch:** Power ON/OFF Momentary (Square), System Reset, Buzzer Reset
- **Dimensions (WxHxD):** 483 x 44 x 700mm (19" x 1.7" x 27.6")
- **Cuft:** 3.1
- **GW:** 14.5kgs / 32.0lbs
- **Carton Size(cm):** 59.4 x 18.2 x 81.8(23.4" x 7.2" x 32.2")
- **Humidity:** 5% - 95% Non-condensing

Dimension

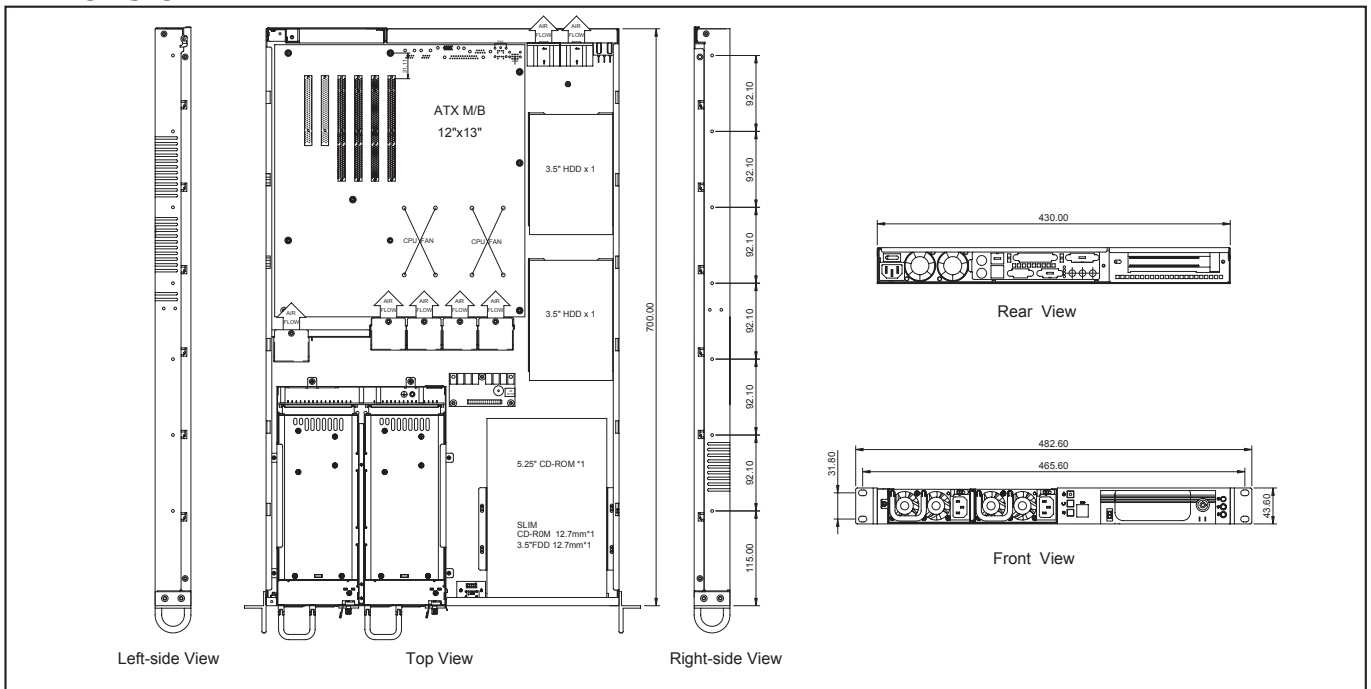

GHI-160

1U Rackmount Chassis

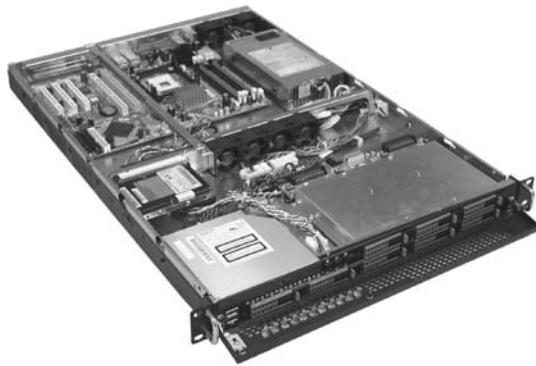

Specifications

- **EIA RS-310C 19" Rackmount Standard**
- **Construction:** Heavy Duty Cold Rolled Electroplated Steel
- **Color:** Black (Standard), Beige or Custom
- **System Boards:** Pentium 4, Dual Xeon, Athlon 64, Dual Opteron
- **Supports EATX M/B (Max. to 12" x 13") SSI EEB 3.0**
- **Drive Capacity:** 8x Hot Swap 2.5" Drive Tray & 1x Slim CD-ROM & 1x 2.5"HDD
- **Drive Interface:** SCSI320 or SAS
- **Power Supply (Optional):** 1U Single up to 500W ATX P/S (Mid Installation) Max. Depth 225mm
- **Cooling:** 6x (40 x 28mm = 15.3CFM ea.) Fans
- **Front Door:** Single Door with 1 Thumbscrew
- **Riser Card:** Please Check Page 193-194 For Optional 1U Riser Card
- **Connector Port (Front):** 2x USB Ports
- **Expansion Slots:** 1x Horizontal PCI Slot
- **Thermal Management Card:** GHA-CO02
- **Indicators:** LEDs for Power ON/OFF, HDD Activity, Fan, Temperature
- **Switch:** Power ON/OFF Momentary (Pushbutton), System Reset, Buzzer Reset
- **Dimensions (WxHxD):** 483 x 44 x 650mm (19" x 1.75" x 25.6")
- **Cuft:** 3.1
- **GW:** 13.8kgs / 30.4 lbs
- **Carton Size (cm):** 59.4 x 18.2 x 81.8 (23.4" x 7.2" x 32.2")
- **Humidity:** 5% - 95% Non-condensing

Dimension

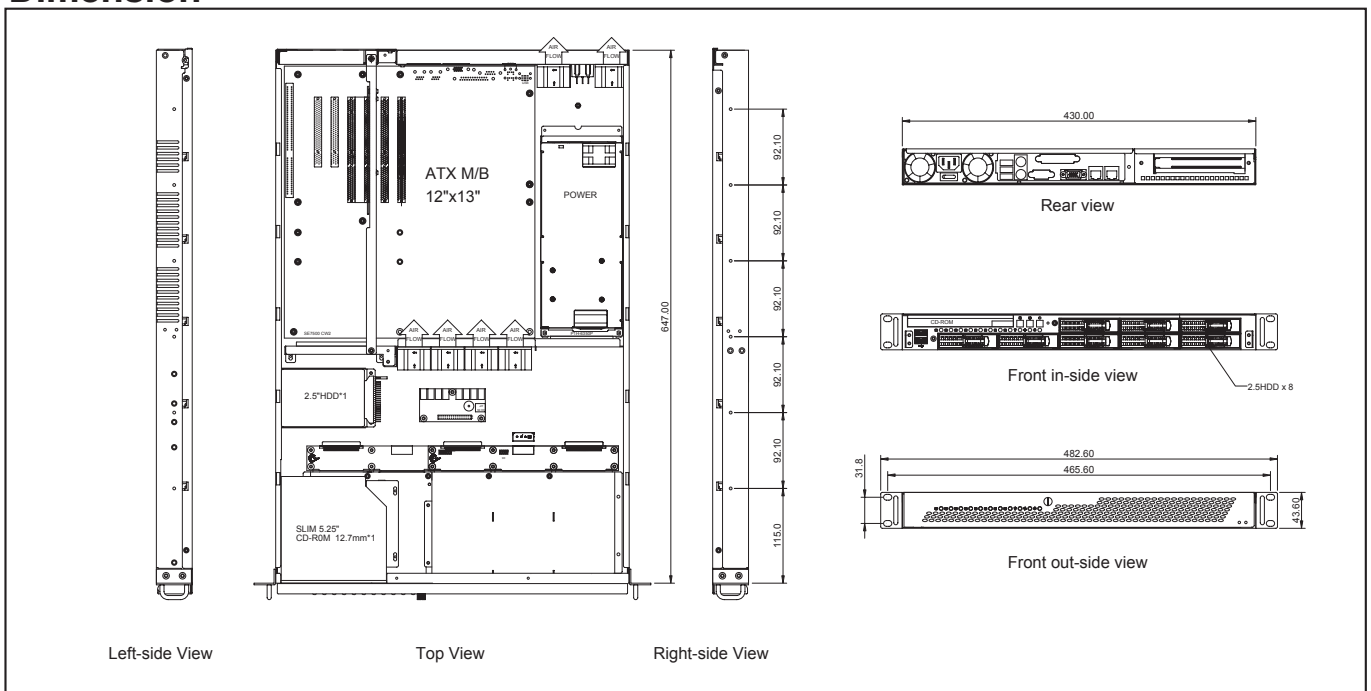

GHI-170

1U Rackmount Chassis



Specifications

- **EIA RS-310C 19" Rackmount Standard**
- **Construction:** Heavy Duty Cold Rolled Electroplated Steel
- **Color:** Black (Standard), Beige or Custom
- **Support Dual ATX M/B (Max. to 6" x 13")**
- **Drive Capacity:** 2x 3.5" HDD
- **Power Supply(Optional):** 1U 200~250W ATX P/S, Max. Depth 190mm
- **Cooling:** 6x (40 x 20mm = 7CFM ea.) & 2x (40 x 28mm=15.3CFM ea.) Fans
- **Front Door:** Single Door With 1 Thumbscrew
- **Riser Card:** Please Check Page 193-194 For Optional 1U Riser Card
- **Connector Port(Front):** 4x USB Ports
- **Expansion Slots:** 2x Horizontal PCI Slot
- **Indicators:** LEDs for Power ON/OFF, HDD Activity , LAN
- **Switch:** Power ON/OFF Momentary, System Reset
- **Dimensions(W x H x D):** 483 x 44 x 542mm (19" x 1.7" x 21.3")
- **Cuft:** 2.6
- **GW:** 10.2 kgs / 22.5 lbs
- **Carton Size(cm):** 68.5 x 18.5 x 57.3 (27" x 7.3" x 22.6")
- **Humidity:** 5% - 95% Non-condensing

Dimension

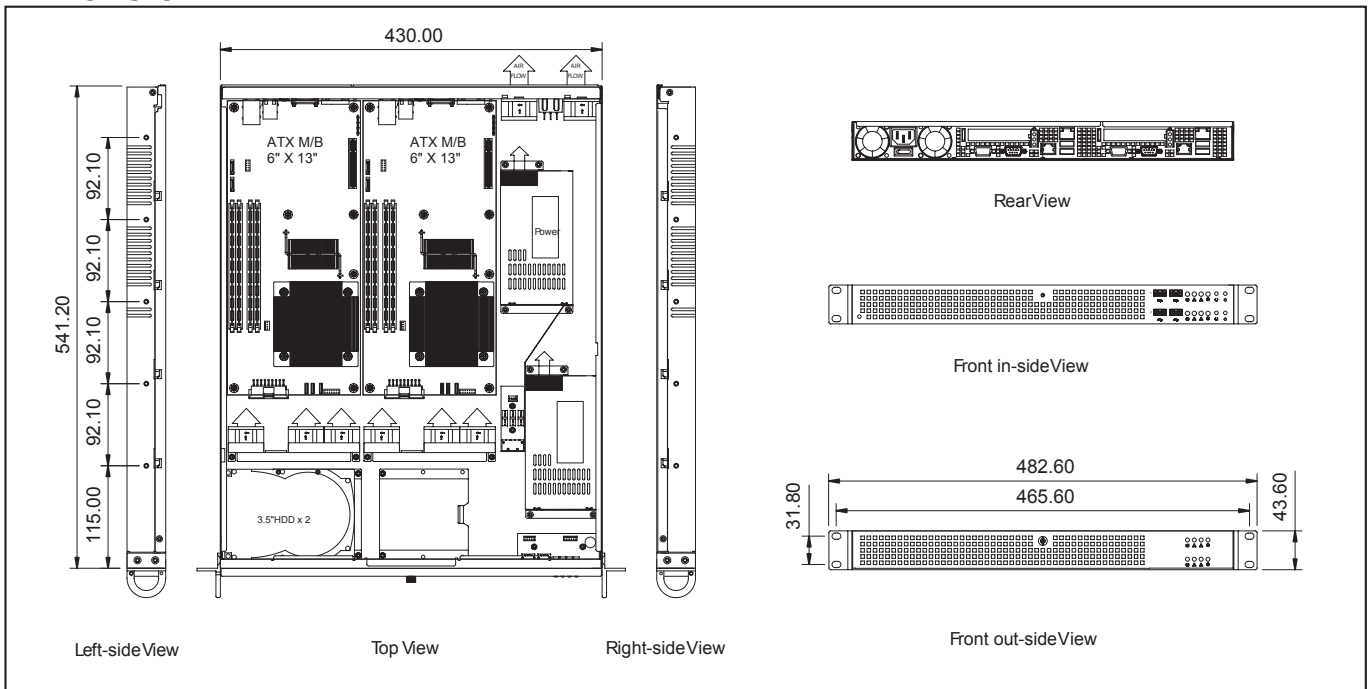

GHI-171

1U Rackmount Chassis



Specifications

- **EIA RS-310C 19" Rackmount Standard**
- **Construction:** Heavy Duty Cold Rolled Electroplated Steel
- **Color:** Black (Standard), Beige or Custom
- **Support Dual Mini-ITX M/B (Max. to 6.7" x 6.7")**
- **Drive Capacity :** 2x 3.5"HDD
- **Power Supply(Optional):** 1U Single 200W ATX P/S Max. Depth 150mm
- **Cooling:** 3x (40mm = 15.3CFM ea.) Fans
- **Connector Port (Front):** 4x USB Ports
- **Indicators:** LEDs for Power ON/OFF, HDD Activity
- **Switch:** Power ON/OFF, System Reset
- **Dimensions (W x H x D):** 483 x 44 x 400mm (19" x 1.7" x 15.8")
- **Cuft:** 2.1
- **GW:** 7.6 kgs / 16.8 lbs
- **Carton Size(cm):** 58 x 18.5 x 55.5 (22.8" x 7.3" x 21.9")
- **Humidity :** 5% - 95% Non-condensing

Dimension

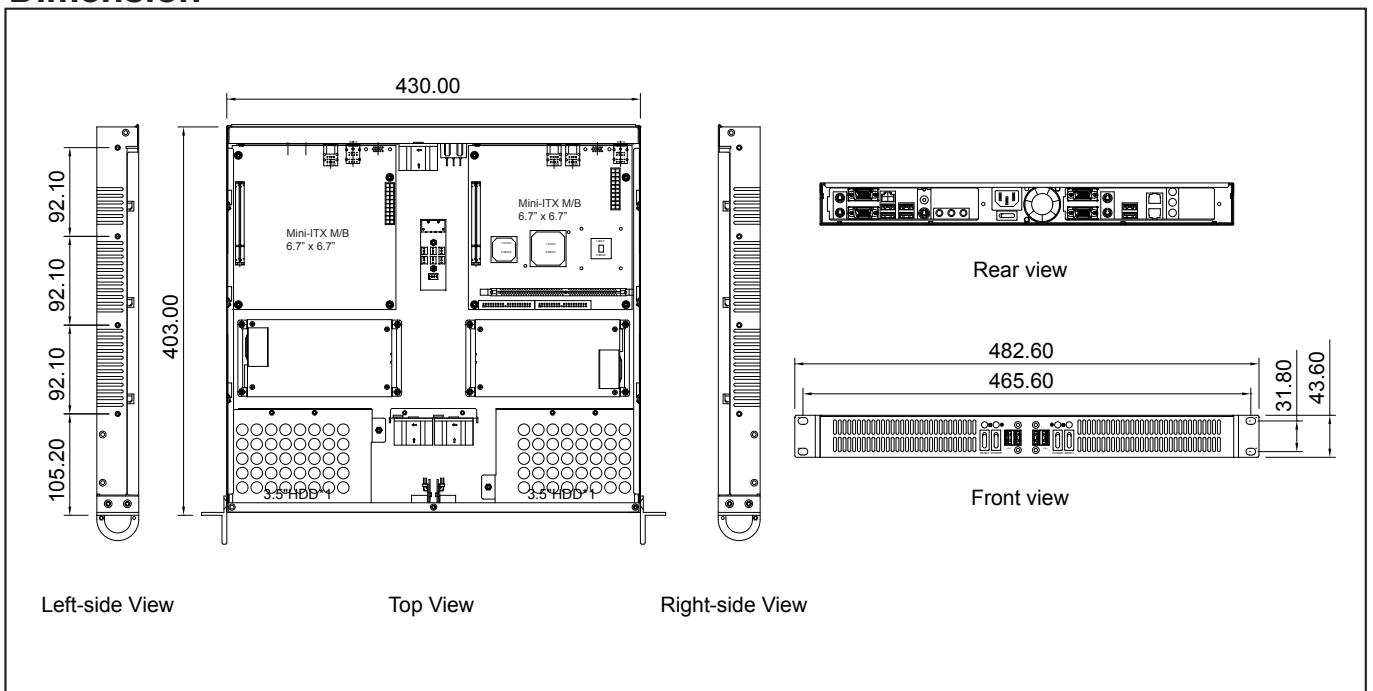

GHI-180

1U Rackmount Chassis



Specifications

- **EIA RS-310C 19" Rackmount Standard**
- **Construction:** Heavy Duty Cold Rolled Electroplated Steel
- **Color:** Black (Standard), Beige or Custom
- **System Boards:** Dual Xeon, Dual Operton, Pentium 4, Dual Pentium III
- **Support EATX M/B (Max. to 12" x 13") SSI EEB 3.0**
- **Drive Capacity:** 1x Slim CD-ROM & 1x Slim FDD & 4x 3.5" Swappable Trays
- **Drive Interface:** PATA, SATA, SCSI320, Multilane SATA or SAS
- **Power Supply(Optional):** 1U Single up to 400W ATX P/S(Mid Installation) Max. Depth 225mm
- **Cooling:** 6x (40 x 28mm = 15.3CFM ea.) Fans
- **Front Door:** Single Door with 1 Thumbscrew
- **Riser Card:** Please Check Page 193-194 For Optional 1U Riser Card
- **Connector Port(Front):** 2x USB Ports
- **Expansion Slots:** 1x Horizontal PCI Slot
- **Indicators:** LEDs for Power ON/OFF, LAN, HDD Activity, Fans, Temperature
- **Switch:** Power ON/OFF Momentary (Pushbutton), System Reset, Buzzer Reset
- **Dimensions (WxHxD):** 483 x 44 x 650mm (19" x 1.7" x 25.6")
- **Cuft:** 2.9
- **GW:** 12.8 kgs / 28.2 lbs
- **Carton Size(cm):** 59.4 x 18.2 x 81.8 (23.4" x 7.2" x 32.2")
- **Humidity:** 5% - 95% Non-condensing

Dimension

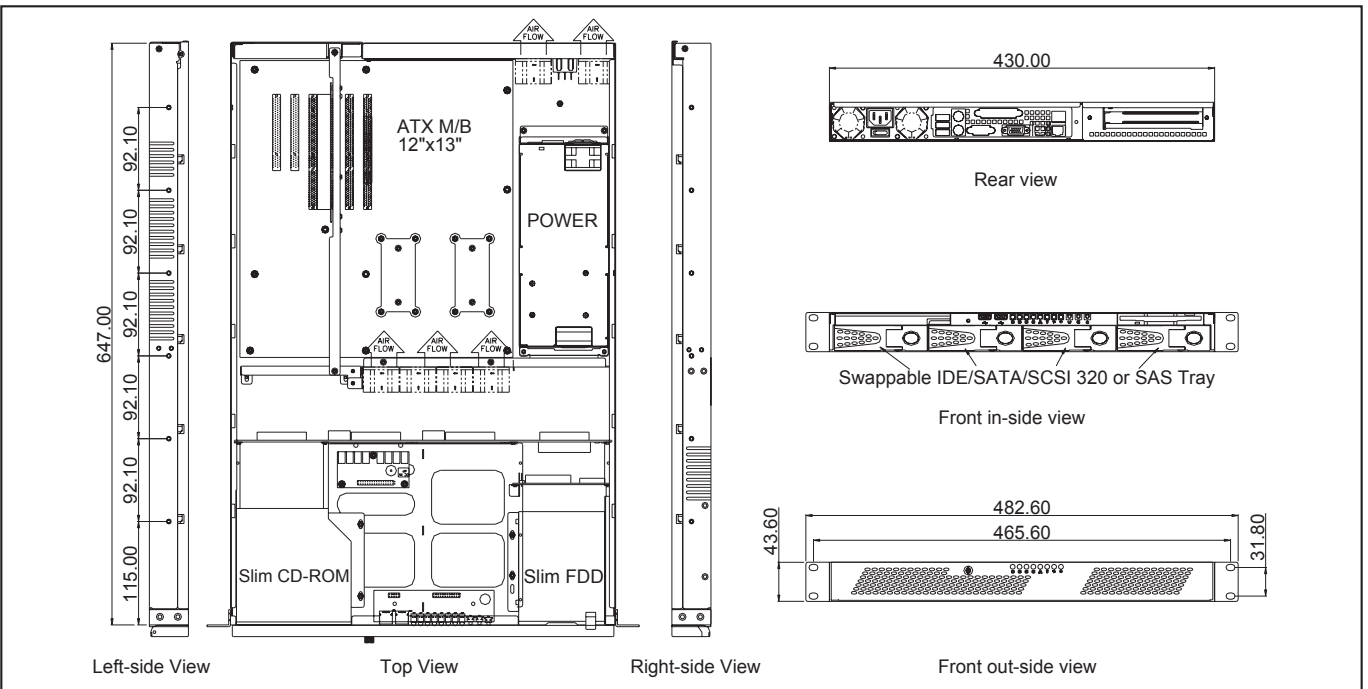

GHI-181

1U Rackmount Chassis



19" Rackmount

Specifications

- **EIA RS-310C 19" Rackmount Standard**
- **Construction:** Heavy Duty Cold Rolled Electroplated Steel
- **Color:** Black (Standard), Beige or Custom
- **System Boards:** Dual Xeon, Pentium 4, Dual Pentium III
- **Support EATX M/B (Max. to 12" x 13") SSI EEB 3.0**
- **Drive Capacity:**
(Option A): 1x 5.25", 1x 3.5" Open & 1x 3.5" Swappable Tary
(Option B): 1x 5.25" & 2x 3.5"Swappable Trays
- **Drive Interface:** PATA, SATA, SCSI320 or SAS
- **Power Supply(Optional):** 1U Single up to 500W ATX P/S(Mid Installation) Max. Depth 225mm
- **Cooling:** 6x (40 x 28mm = 15.3CFM ea.) Fans, 1x (40 x 28mm = 15.3CFM ea.)Fans (Optional)
- **Front Door:** Single Door with 1 Thumbscrew
- **Riser Card:** Please Check Page 193-194 For Optional 1U Riser Card
- **Connector Port (Front):** 2x USB Ports
- **Expansion Slots:** 1x Horizontal PCI Slot
- **Indicators:** LEDs for Power ON/OFF, LAN, HDD Activity
- **Switch:** Power ON/OFF Momentary (Square), System Reset
- **Dimensions (WxHxD):** 483 x 44 x 650mm (19" x 1.7" x 25.6")
- **Cuft:** 2.9
- **GW:** 12.8kgs / 28.2lbs
- **Carton Size(cm):** 59.4 x 18.2 x 81.8 (23.4" x 7.2" x 32.2")
- **Humidity:** 5% - 95% Non-condensing

Dimension

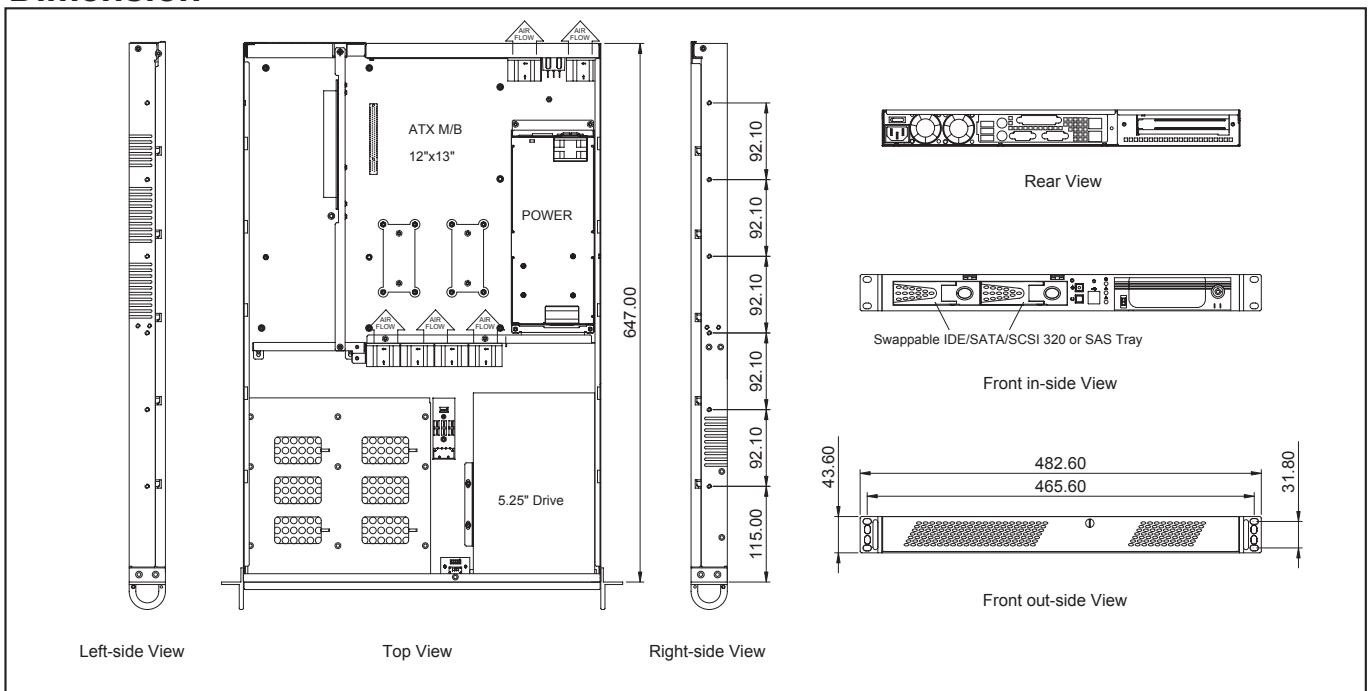

GHI-182

1U Rackmount Chassis



Specifications

- **EIA RS-310C 19" Rackmount Standard**
- **Construction:** Heavy Duty Cold Rolled Electroplated Steel
- **Color:** Black (Standard), Beige or Custom
- **System Boards:** Dual Xeon, Pentium 4, Dual Pentium III
- **Support EATX M/B (Max. to 12" x 13") SSI EEB 3.0**
- **Drive Capacity:** 1x Slim CD-ROM & 1x Slim FDD & 4x 3.5"Swappable Trays
- **Drive Interface:** PATA, SATA, SCSI320, Multilane SATA or SAS
- **Power Supply(Optional):** 1U Redundant up to 400W ATX P/S (Rear Installation)
- **Cooling:** 5x (40 x 28mm = 15.3CFM ea.) Fans
- **Front Door:** Single Door With 1 Thumbscrew
- **Riser Card:** Please Check Page 193-194 For Optional 1U Riser Card
- **Connector Port(Front):** 2x USB Ports
- **Expansion Slots:** 1x Horizontal PCI Slot
- **Indicators:** LEDs for Power ON/OFF, LAN, HDD Activity
- **Switch:** Power ON/OFF Momentary (Pushbutton), System Reset
- **Dimensions (W x H x D):** 483 x 44 x 650mm (19" x 1.7" x 25.6")
- **Cuft:** 2.9
- **GW:** 12.8 kgs / 28.2 lbs
- **Carton Size(cm):** 59.4 x 18.2 x 81.8 (23.4" x 7.2" x 32.2")
- **Humidity:** 5% - 95% Non-condensing

Dimension

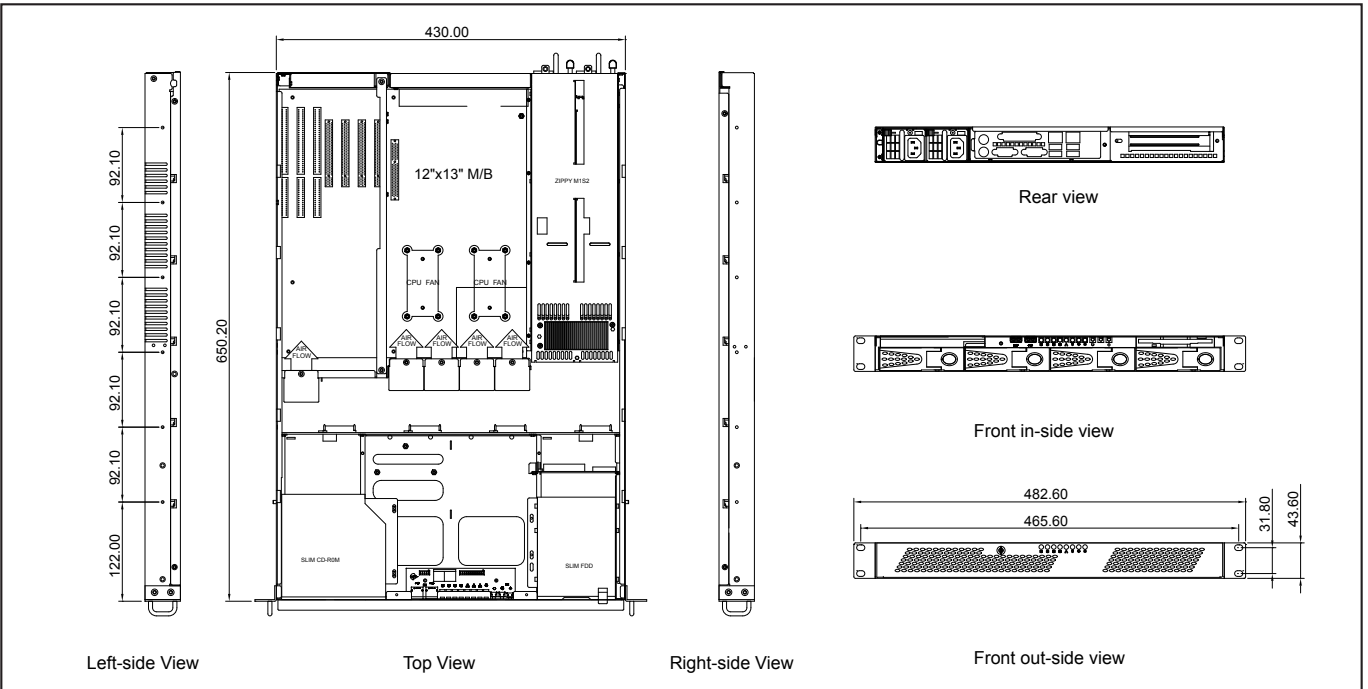

GH-188ATX

1U Rackmount Chassis

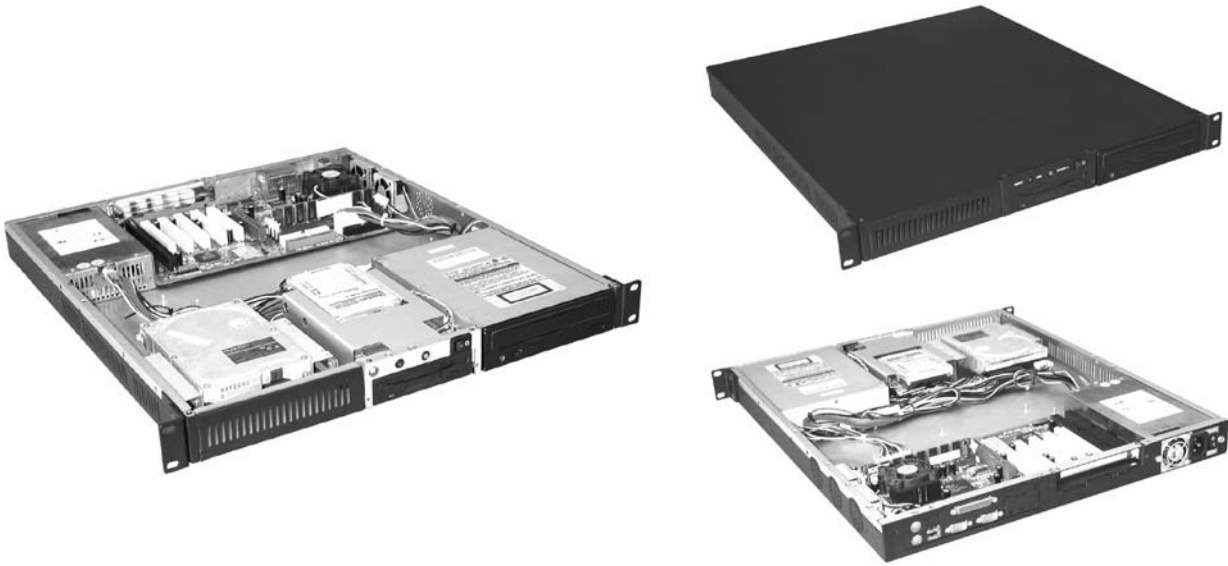

Specifications

- **EIA RS-310C 19" Rackmount Standard**
- **Construction:** Heavy Duty Cold Rolled Electroplated Steel
- **Color:** Black (Standard), Beige or Custom
- **System Boards:** Pentium 4
- **Support ATX M/B (Max. to 12" x 9.6")**
- **Drive Capacity:** 2x 5.25" & 1x 3.5" & 1x 2.5" HDD
- **Power Supply(Optional):** 1U Single up to 300W ATX P/S (Rear Installation) Max. Depth 205mm
- **Cooling:** 2x (40 x 20mm = 7CFM ea.) Fans, 1x (40 x 20mm = 7CFM ea.) Fans (Optional)
- **Riser Card:** Please Check Page 193-194 For Optional 1U Riser Card
- **Expansion Slots:** 1x Horizontal PCI Slot
- **Indicators:** LEDs for Power ON/OFF, HDD Activity
- **Switch:** Power ON/OFF Momentary (Rocker), System Reset
- **Dimensions (WxHxD):** 483 x 44 x 520mm (19" x 1.7" x 20.5")
- **Cuft:** 2.5
- **GW:** 8.0 kgs / 17.6 lbs
- **Carton Size(cm):** 57.5 x 18.5 x 66.7(22.6" x 7.3" x 26.3")
- **Humidity:** 5% - 95% Non-condensing

Dimension

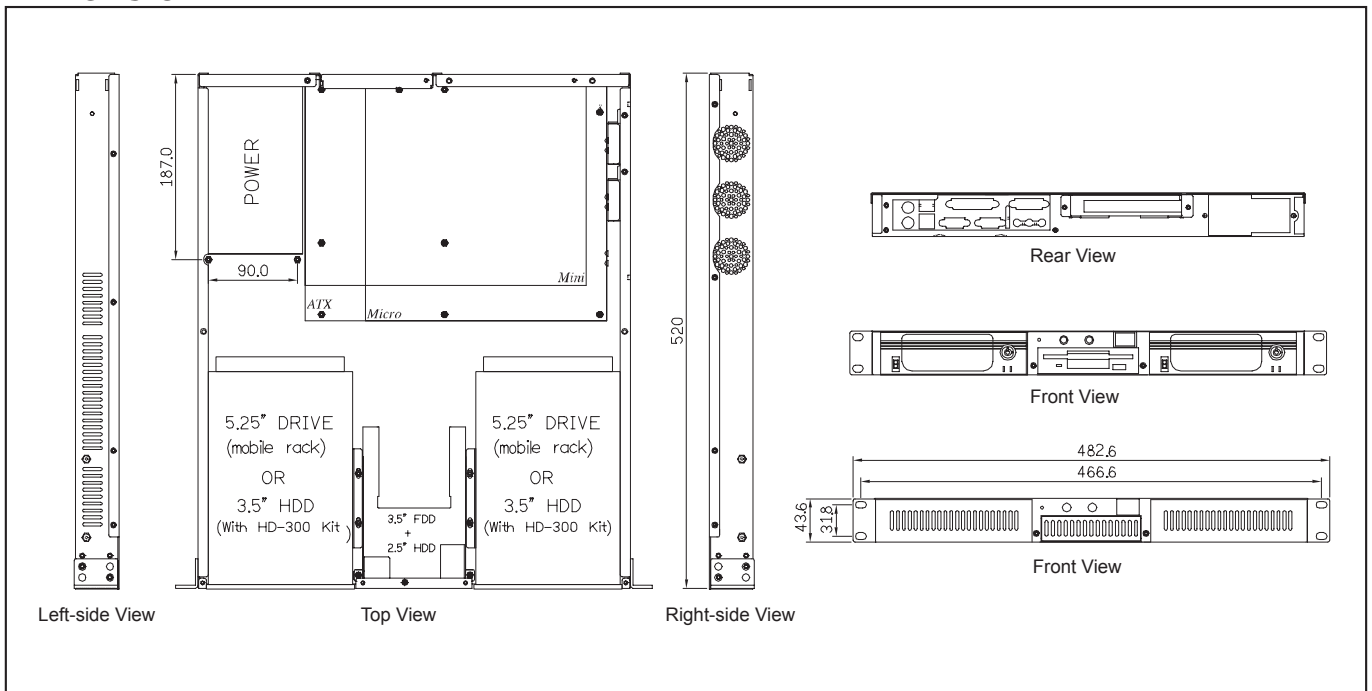

GHI-189

1U Rackmount Chassis

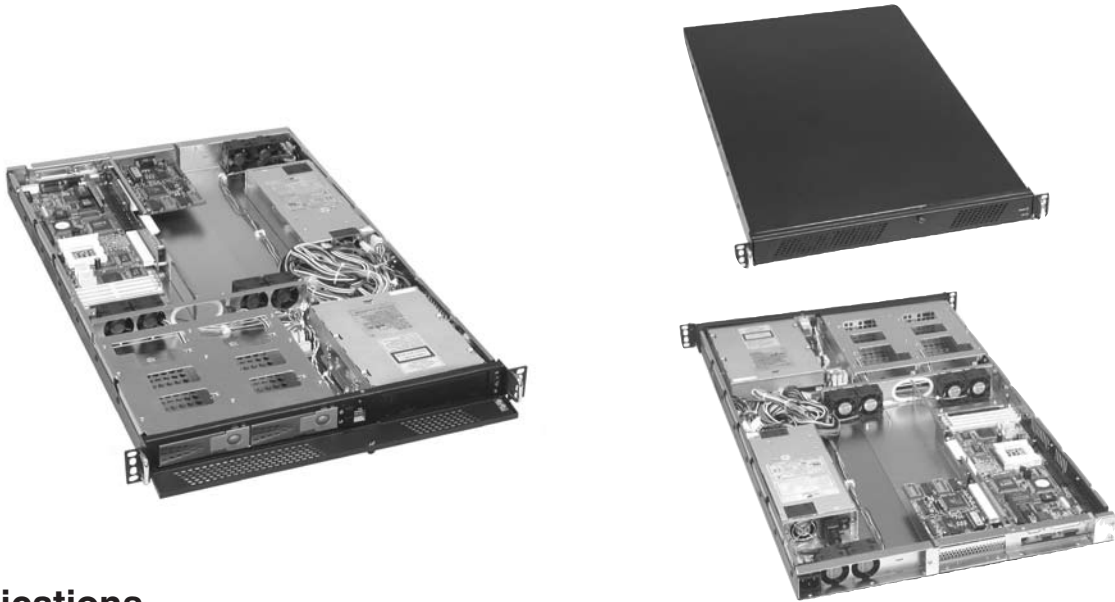

Specifications

- **EIA RS-310C 19" Rackmount Standard**
- **Construction:** Heavy Duty Cold Rolled Electroplated Steel
- **Color:** Black (Standard), Beige or Custom
- **Supports 4 Slot Passive Backplane**
- **Drive Capacity:** 1x 5.25" & 2x Hot Swap Drive Trays
- **Drive Interface:** PATA, SATA, SCSI320 or SAS
- **Power Supply (Optional):** 1U Single up to 500W ATX P/S (Mid Installation) Max. Depth 225mm
- **Cooling:** 6x (40 x 28mm = 15CFM ea.) Fans & 1x (40 x 20mm = 7CFM ea.) (Optional)
- **Connector Port (Front):** 2x USB Ports
- **Front Door:** Single Door with 1 Thumbscrew
- **Indicators:** LEDs for Power ON/OFF, HDD Activity, LAN
- **Switch:** Power ON/OFF Momentary (Square Pushbutton), System Reset
- **Dimensions (WxHxD):** 483 x 44 x 650mm (19" x 1.7" x 25.6")
- **Cuft:** 3.1
- **GW:** 13.1 kgs / 28.9 lbs
- **Carton Size (cm):** 59.4 x 18.2 x 81.8 (23.4" x 7.2" x 32.2")
- **Humidity:** 5% - 95% Non-condensing

Dimension

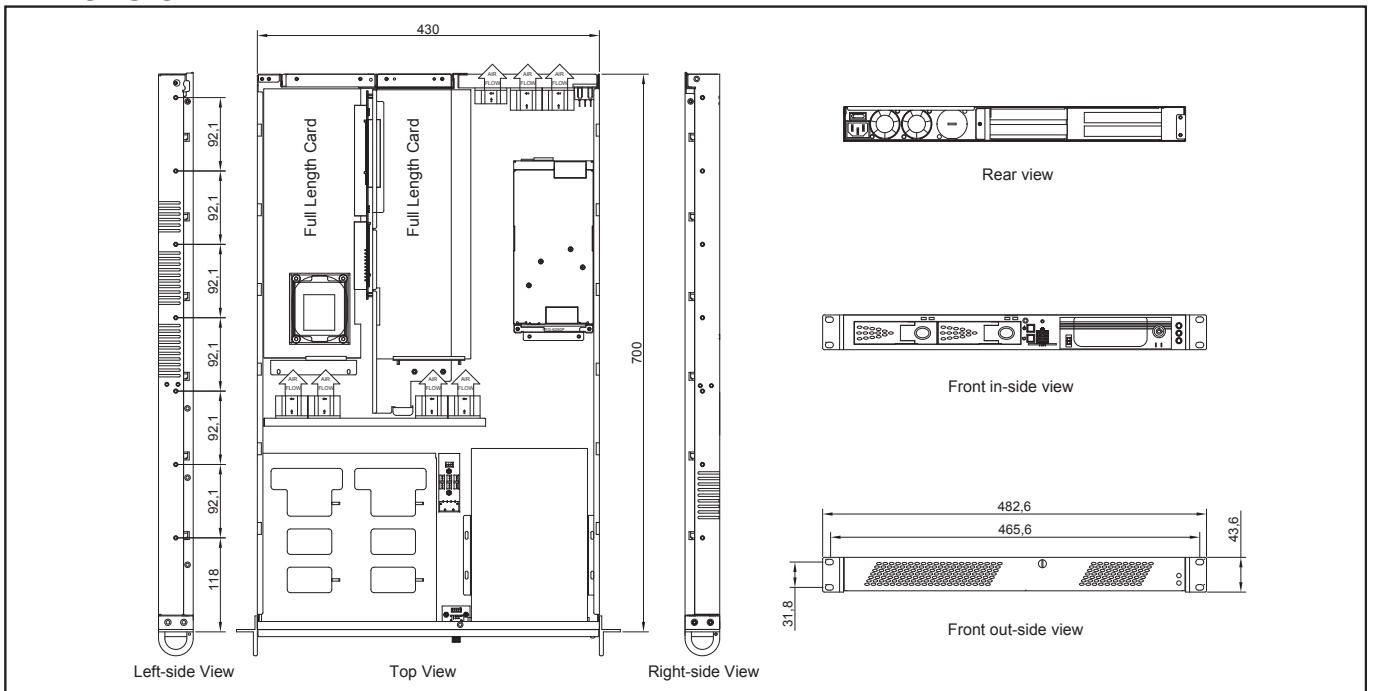

GHI-192

1U Rackmount Chassis



19" Rackmount

Specifications

- **EIA RS-310C 19" Rackmount Standard**
- **Construction:** Heavy Duty Cold Rolled Electroplated Steel
- **Color:** Black (Standard), Beige or Custom
- **System Boards:** Dual Xeon, Dual Operton, Pentium 4, Dual Pentium III
- **Support ATX M/B (Max. to 12" x 10.5") SSI EEB 3.0**
- **Drive Capacity:** 1x 5.25" Slim CD-ROM & 2x 3.5"Swapple Tray & 1x 5.25" CD-ROM or GHA-FM05 (Optional)
- **Drive Interface:** PATA, SATA, SCSI320 or SAS
- **Power Supply(Optional):** 1U Single up to 500W ATX P/S(Mid Installation) Max. Depth 225mm
- **Cooling:** 6x (40 x 20mm = 7CFM ea.) Fans
- **Connector Port(Front):** 2x USB Ports
- **Front Door:** Single Door With 1 Thumbscrew
- **Riser Card:** Please Check Page 193-194 For Optional 1U Riser Card
- **Indicators:** LEDs for Power ON/OFF, HDD Activity
- **Switch:** Power ON/OFF, System Reset
- **Dimensions (W x H x D):** 483 x 44 x 560mm (19" x 1.7" x 22.1")
- **Cuft:** 2.1
- **GW:** 10.8kgs / 23.8lbs
- **Carton Size(cm):** 56 x 15.3 x 69 (22.1" x 6" x 27.2")
- **Humidity:** 5% - 95% Non-condensing

Dimension

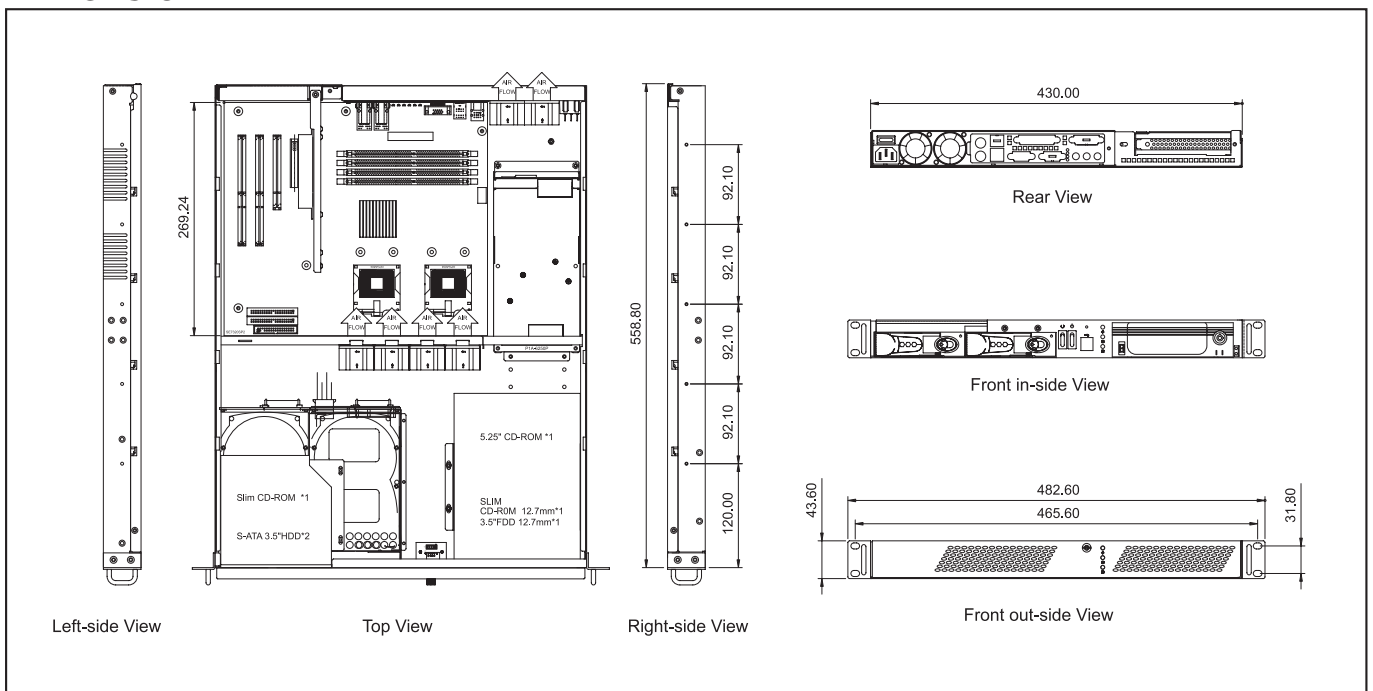

GHI-200

2U Rackmount Chassis

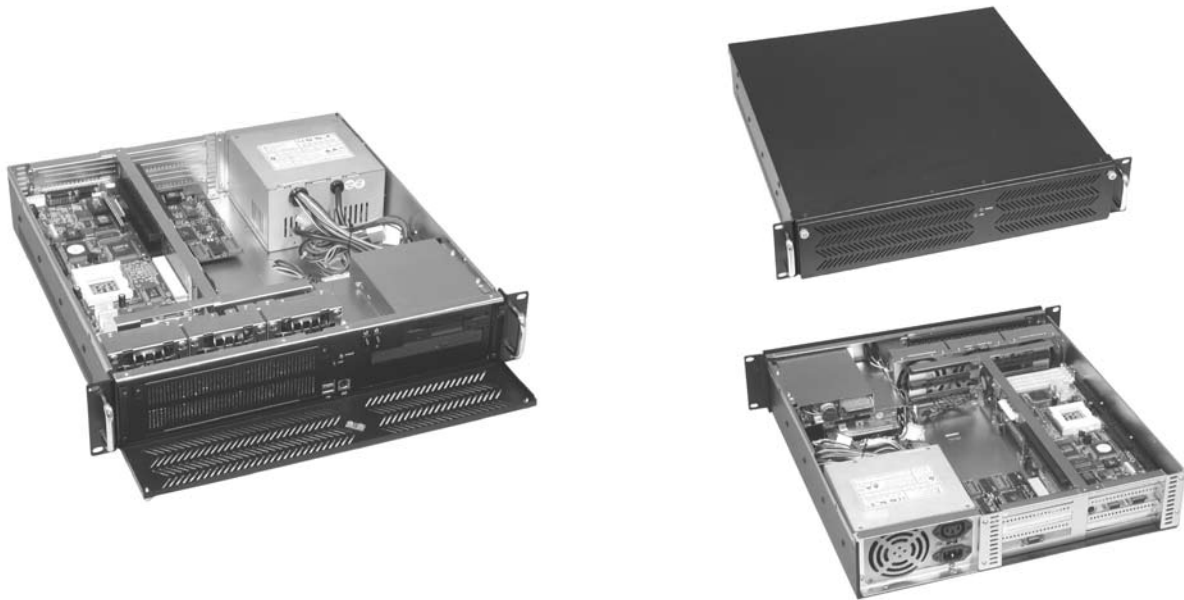

Specifications

- **EIA RS-310C 19" Rackmount Standard**
- **Construction:** Heavy Duty Cold Rolled Electroplated Steel
- **Color:** Black (Standard), Beige or Custom
- **Support 6-slot Passive Backplane**
- **Drive Capacity:** 1x 5.25" (or 1xSlim CD-ROM & 1x 3.5"HDD) & 1x 3.5"FDD
- **Power Supply(Optional):** PS/2 size single up to 400W or Mini Redundant up to 400W ATX P/S (Rear Installation)
- **Cooling:** 3x (80 x 25mm = 42.5CFM ea.) Fans
- **Front Door:** Single Door with 2 Thumbscrews
- **Air Filter:** Inside Front Panel (Washable)
- **Connector Port (Front):** 2x USB & 1x PS/2 Ports
- **Indicators:** LEDs for Power ON/OFF, HDD Activity
- **Switch:** Power ON/OFF Momentary(Rocker), System Reset
- **Dimensions (WxHxD):** 483 x 88 x 450mm (19"x3.5"x17.7")
- **Cuft:** 3.2
- **GW:** 13.0kgs / 28.7lbs
- **Carton Size(cm):** 63 x 24.8 x 57.4 (24.8" x 9.8" x 22.6")
- **Humidity:** 5% - 95% Non-condensing

Dimension

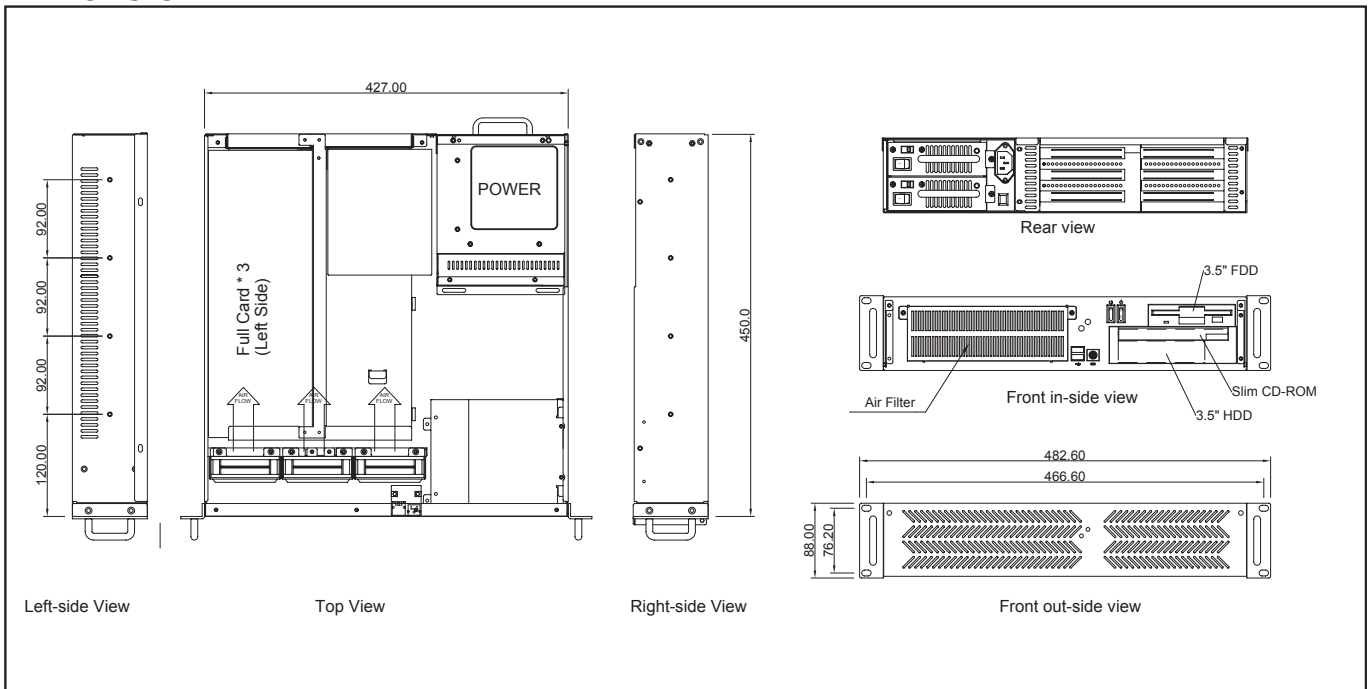

GHI-201

2U Rackmount Chassis



Specifications

- **EIA RS-310C 19" Rackmount Standard**
- **Construction:** Heavy Duty Cold Rolled Electroplated Steel
- **Color:** Black (Standard), Beige or Custom
- **Support 6-slot Passive Backplane**
- **Drive Capacity:** 1x 5.25" Slim CD-ROM & 2x 3.5" Swappable Trays
- **Power Supply (Optional):** PS/2 Size Single or Mini Redundant P/S (Rear Installation)
- **Cooling:** 3x (80mm = 42.5CFM ea.) Fans
- **Front Door:** Single Door With 2 Thumbscrews
- **Air Filter:** Inside Front Panel (Washable)
- **Connector Port (Front):** 2x USB & 1x PS/2 Ports
- **Indicators:** LEDs for Power ON/OFF, HDD Activity
- **Switch:** Power ON/OFF Momentary(Rocker), System Reset
- **Dimensions(WxHxD):** 483 x 88 x 450mm(19" x 3.5" x 17.7")
- **Cuft:** 3.2
- **GW:** 13.4 kgs / 29.5 lbs
- **Carton Size(cm):** 63 x 24.8 x 57.4 (24.8" x 9.8" x 22.6")
- **Humidity:** 5% - 95% Non-condensing

Dimension

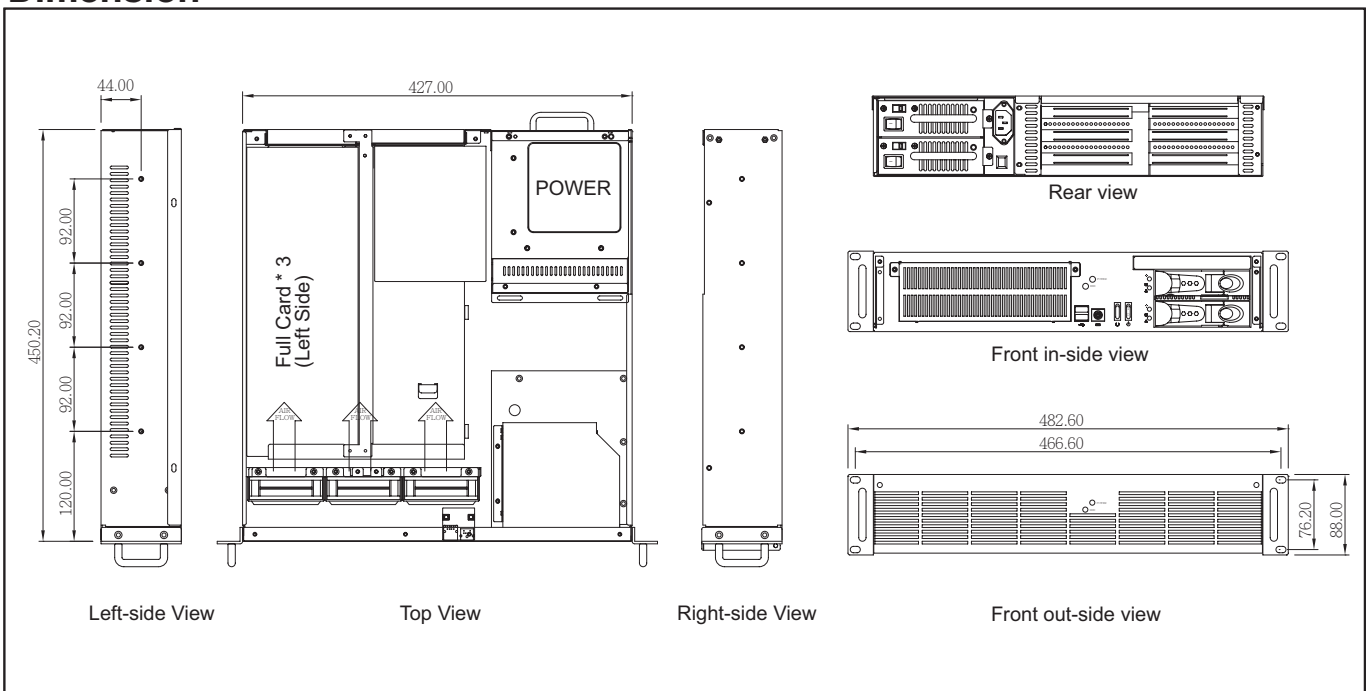

GHI-202

2U Rackmount Chassis



Specifications

- **EIA RS-310C 19" Rackmount Standard**
- **Construction:** Heavy Duty Cold Rolled Electroplated Steel
- **Color:** Black (Standard), Beige or Custom
- **Support 3-Slot Half-Size Passive Backplane**
- **Drive Capacity:** 1x 5.25" & 3x 3.5" HDD
- **Power Supply (Optional):** 1U Single up to 300W ATX P/S (Rear Installation) Max. Depth 205mm
- **Cooling:** 3x (80mm = 42.5CFM ea.) Fans
- **Connector Port (Front):** 2x USB Ports
- **Indicators:** LEDs for Power ON/OFF, LAN, HDD Activity
- **Switch:** Power ON/OFF Momentary (Rocker), System Reset
- **Dimensions (W x H x D):** 483 x 88 x 300mm (19" x 3.5" x 11.8")
- **Cuft:** 2.2
- **GW:** 9.0 kgs / 19.8 lbs
- **Carton Size(cm):** 57 x 22 x 48.8 (22.4" x 8.7" x 19.2")
- **Humidity:** 5% - 95% Non-condensing

Dimension

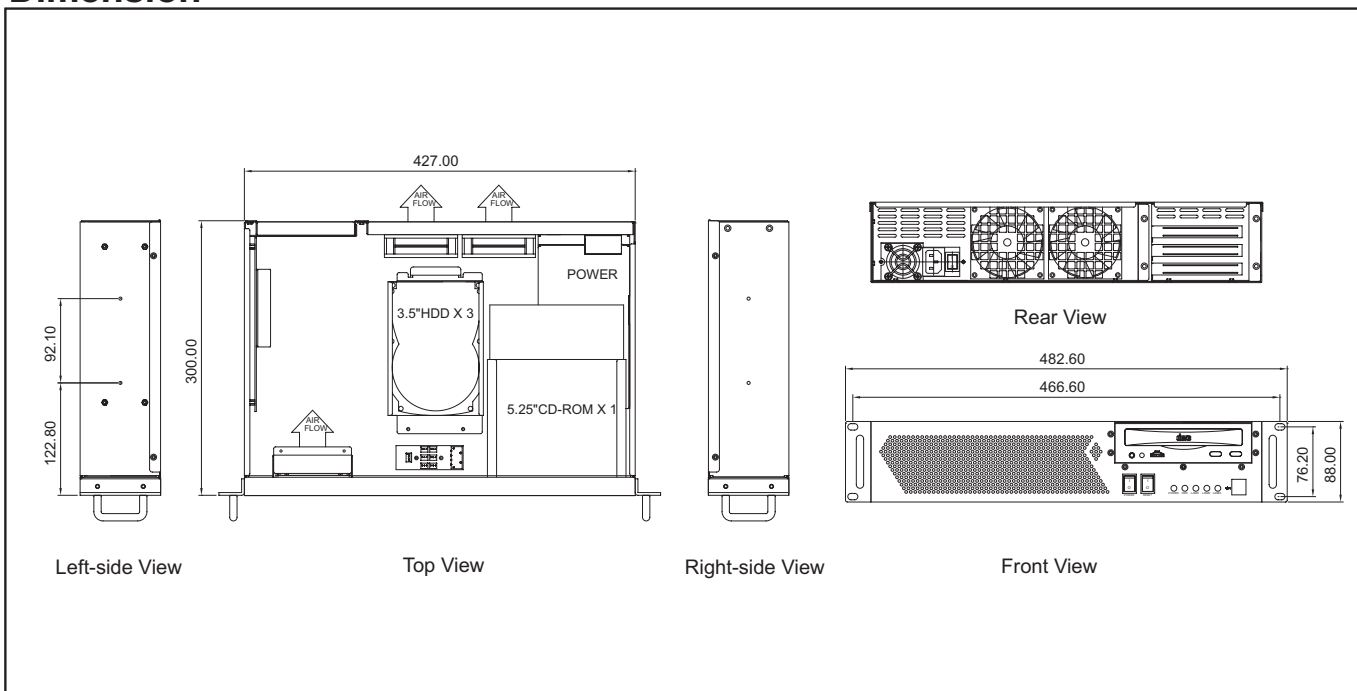

GHI-210

2U Rackmount Chassis



19" Rackmount

Specifications

- **EIA RS-310C 19" Rackmount Standard**
- **Construction:** Heavy Duty Cold Rolled Electroplated Steel
- **Color:** Black (Standard), Beige or Custom
- **System Boards:** Dual Xeon, Pentium 4, Dual Pentium III
- **Support ATX M/B (Max. to 12" x 9.6")**
- **Drive Capacity:** 1x 5.25"(or 1xSlim CD-ROM & 1 x 3.5"HDD) & 1x 3.5" & 3x 3.5" HDD
- **Power Supply (Optional):** 2U Single up to 400W or Redundant up to 350W ATX P/S (Rear Installation)
- **Cooling:** 3x (80mm = 42.5CFM ea.) Fans
- **Connector Port (Front):** 2x USB Ports
- **Front Door:** Single Door with 2 Thumbscrews
- **Air Filter:** Inside Front Panel (Washable)
- **Riser Card:** Please Check Page 194-196 For Optional 2U Riser Card
- **Expansion Slots(Optional):** 2 or 3x Horizontal ISA/PCI/AGP Option Slots
- **Indicators:** LEDs for Power ON/OFF, HDD Activity
- **Switch:** Power ON/OFF Momentary (Square), System Reset
- **Dimensions (WxHxD):** 483 x 88 x 450mm (19" x 3.5" x 17.7")
- **Cuft:** 3.2
- **GW:** 11.6 kgs / 25.6 lbs
- **Carton Size(cm):** 63 x 24.8 x 57.4(24.8" x 9.8" x 22.6")
- **Humidity:** 5% - 95% Non-condensing

Dimension

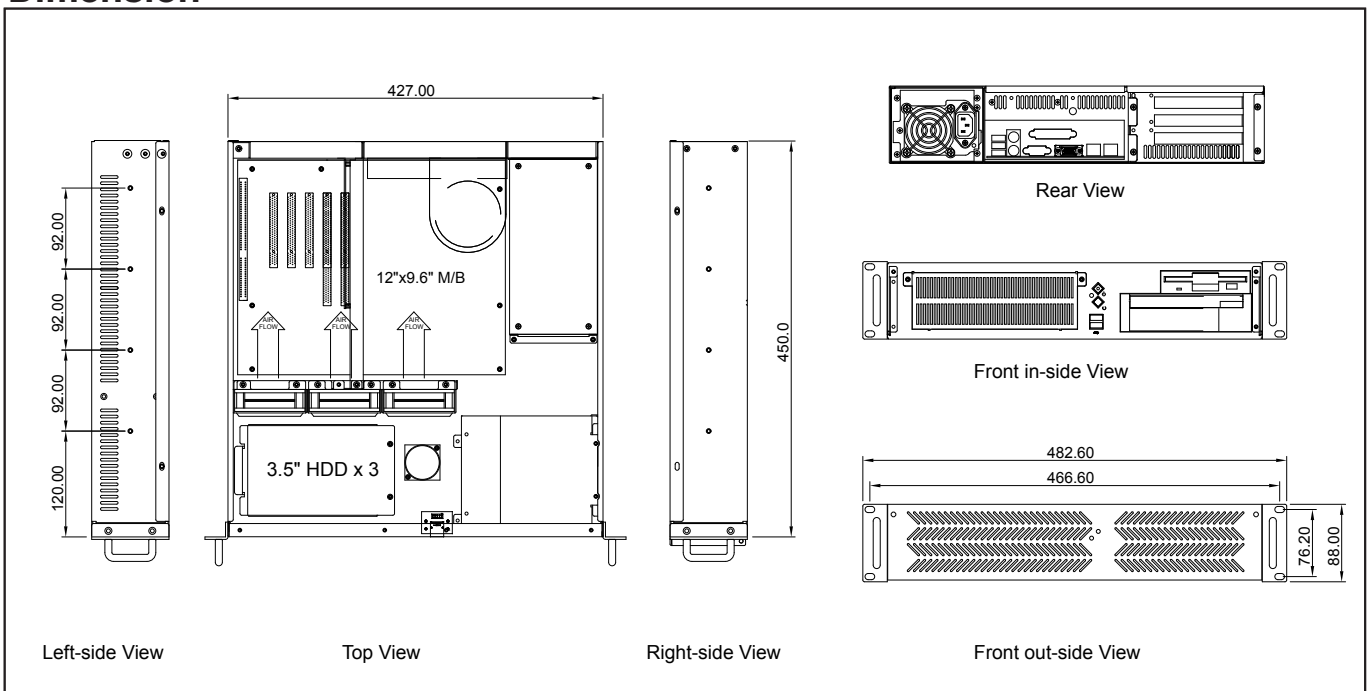

GH-212ATX

2U Rackmount Chassis



Specifications

- **EIA RS-310C 19" Rackmount Standard**
- **Construction:** Heavy Duty Cold Rolled Electroplated Steel
- **Color:** Black (Standard), Beige or Custom
- **System Boards:** Pentium 4
- **Support ATX M/B (Max. to 12" x 9.6")**
- **Drive Capacity:** 1x 5.25" & 1x 3.5" & 2x 3.5"HDD
- **Power Supply(Optional):** PS/2 Size Single up to 460W ATX P/S (Front/Mid Installation)
- **Cooling:** 1x (60mm = 23.5CFM ea.) & 1x (80mm = 42.5CFM ea.) Fan
- **Front Door:** Single Door with 1 Thumb Twist Keylock
- **Air Filter:** Inside Front Panel (Washable)
- **Riser Card:** Please Check Page 194-196 For Optional 2U Riser Card
- **Connector Port (Front):** 2x USB Ports (Optional)
- **Expansion Slots (Optional):** 2 or 3x Horizontal ISA/PCI/AGP Option Slots
- **Indicators:** LEDs for Power ON/OFF, HDD Activity
- **Switch:** Power ON/OFF Momentary (Rocker), System Reset
- **Dimensions (WxHxD):** 483 x 88 x 501mm (19" x 3.5" x 19.7")
- **Cuft:** 3.6
- **GW:** 12.0kgs / 26.5lbs
- **Carton Size(cm):** 58.8 x 25.5 x 68.5 (23.1" x 10" x 27")
- **Humidity:** 5% - 95% Non-condensing

Dimension

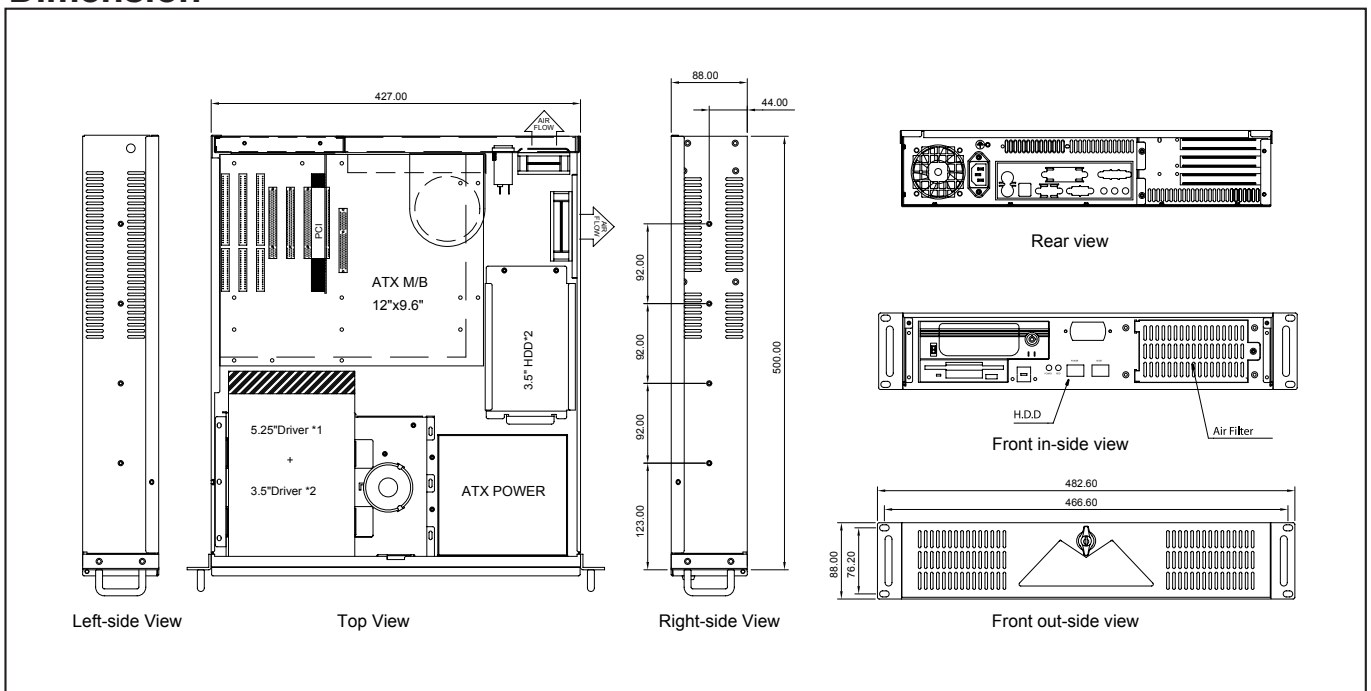

GHI-213

2U Rackmount Chassis



Specifications

- **EIA RS-310C 19" Rackmount Standard**
- **Construction:** Heavy Duty Cold Rolled Electroplated Steel
- **Color:** Black (Standard), Beige or Custom
- **System Boards:** Pentium 4, Athlon 64
- **Support ATX M/B (Max. to 12" x 9.6")**
- **Drive Capacity:** 1x 5.25" & 1x 3.5" & 3x 3.5"HDD
- **Power Supply (Optional):** 2U Single up to 400W or Redundant up to 350W ATX P/S (Rear Installation) Max. Depth 215mm
- **Cooling:** 3x (80 mm = 42.5CFM ea.) Fans
- **Front Door:** Single Door with 2 Thumbscrews
- **Air Filter:** Inside Front Panel (Washable)
- **Riser Card:** Please Check Page 194-196 For Optional 2U Riser Card
- **Connector Port (Front):** 2x USB Ports
- **Expansion Slots(Optional):** 2 or 3x Horizontal ISA/PCI/AGP Option Slots
- **Indicators:** LEDs for Power ON/OFF, HDD Activity
- **Switch:** Power ON/OFF, System Reset
- **Dimensions (WxHxD):** 483 x 88 x 450mm (19" x 3.5" x 17.7")
- **Cuft:** 3.2
- **GW:** 14.0kgs / 30.9lbs
- **Carton Size(cm):** 63 x 24.8 x 57.4 (24.8" x 9.8" x 22.6")
- **Humidity:** 5% - 95% Non-condensing

Dimension

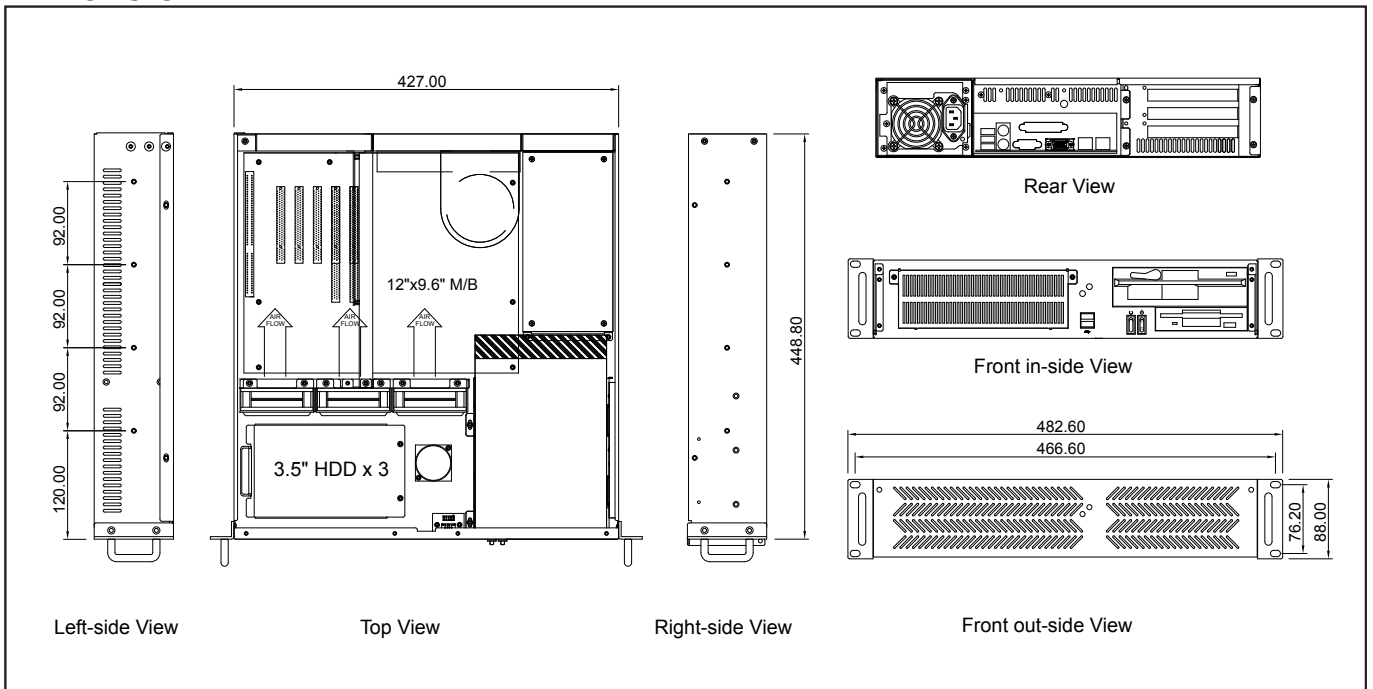

GHI-214

2U Rackmount Chassis



Specifications

- **EIA RS-310C 19" Rackmount Standard**
- **Construction:** Heavy Duty Cold Rolled Electroplated Steel
- **Color:** Black (Standard), Beige or Custom
- **System Boards:** Pentium 4, Athlon 64, Dual Xeon, Dual Opteron
- **Support EATX M/B (Max. to 12" x 13")**
- **Drive Capacity:** 1x 5.25" & 1x 3.5" & 5.25" Slim CD-ROM & 3x 3.5"HDD
- **Power Supply (Optional):** 2U Single up to 510W or Redundant up to 400W ATX PSU (Rear Installation) Max. Depth 300mm
- **Cooling:** 3 x (80mm=42.5CFM ea.) Fans
- **Connector Port (Front):** 2x USB Ports
- **Front Door:** Single Door With 2 Thumbscrews
- **Air Filter:** Inside Front Panel (Washable)
- **Riser Card:** Please Check Page 194-196 For Optional 2U Riser Card
- **Expansion Slots(Optional):** 2 or 3x Horizontal ISA/PCI/AGP Option Slots
- **Indicators:** LEDs for Power ON/OFF, HDD Activity
- **Switch:** Power ON/OFF, System Reset
- **Dimensions (W x H x D):** 483 x 88 x 510mm (19" x 3.5" x 20.1")
- **Cuft:** 3.5
- **GW:** 10.3 kgs / 22.7 lbs
- **Carton Size(cm):** 59 x 24.5 x 69.3 (23.2" x 9.7" x 27.3")
- **Humidity:** 5% - 95% Non-condensing

Dimension

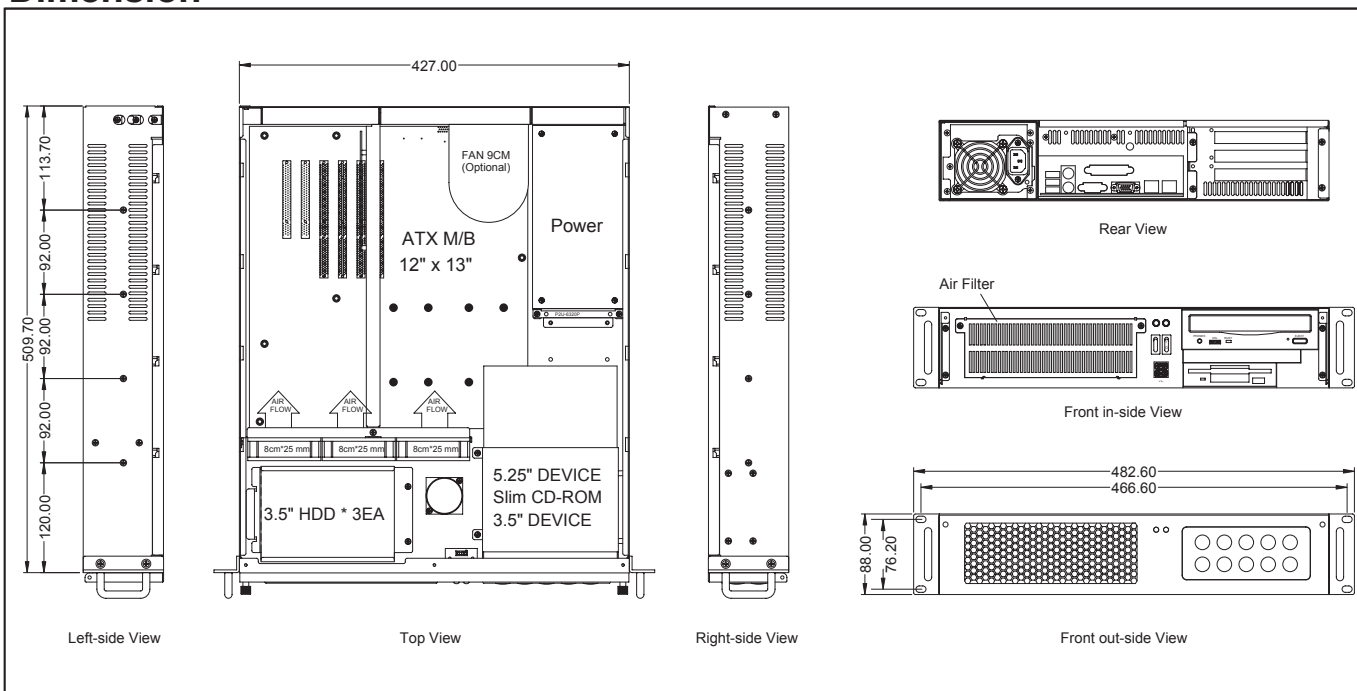

GHI-220

2U Rackmount Chassis

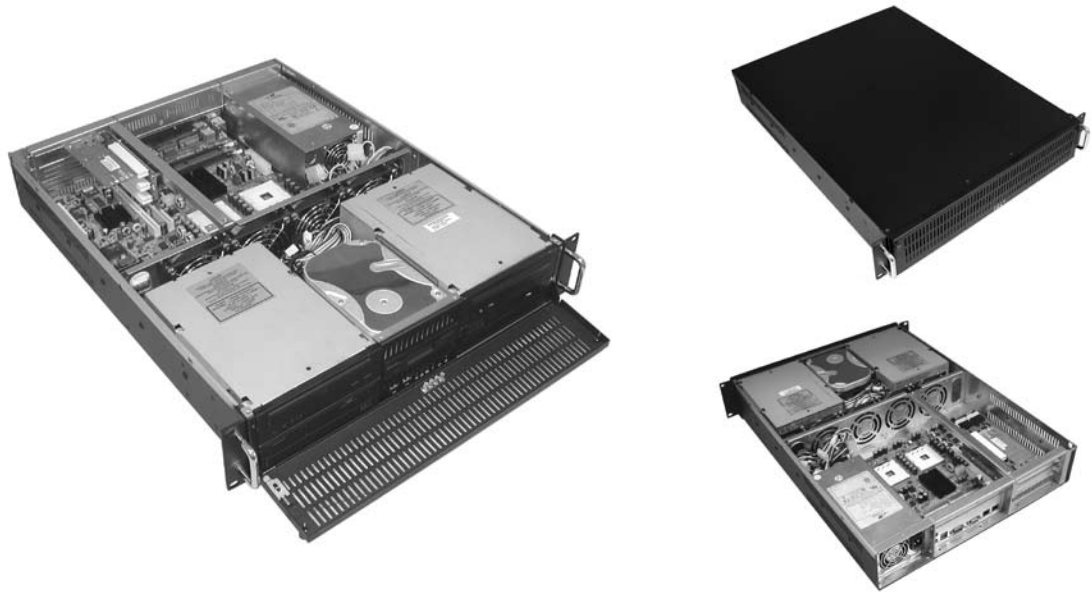

19" Rackmount

Specifications

- **EIA RS-310C 19" Rackmount Standard**
- **Construction:** Heavy Duty Cold Rolled Electroplated Steel
- **Color:** Black (Standard), Beige or Custom
- **System Boards:** Pentium 4, Dual Xeon, Athlon 64, Dual Opteron
- **Support ATX M/B (Max. to 12" x 10.5")**
- **Drive Capacity:** 4x 5.25" & 2x 3.5"HDD & 1x 3.5"FDD or 6 Storage Module & 2x 3.5"HDD & 1x 3.5"FDD
- **Power Supply (Optional):** 2U Single up to 510W or Redundant up to 400W ATX P/S (Rear Installation) Max. Depth 265mm
- **Cooling:** 4x (80mm = 42.5CFM ea.)
- **Front Door:** Single Door With 2 Thumbscrew and Removeable Door
- **Connector Port (Front):** 2 x USB Ports
- **Indicators:** LEDs for Power ON/OFF, HDD Activity , 2x LAN
- **Switch:** Power ON/OFF Momentary (Dimple), System Reset
- **Dimensions (W x H x D):** 483 x 88 x 570mm (19" x 3.5" x 22.4")
- **Cuft:** 2.9
- **GW:** 13.4 kgs / 29.5 lbs
- **Carton Size(cm):** 56.2 x 20.3 x 71.3 (22.1" x 8" x 28.1")
- **Humidity:** 5% - 95% Non-condensing

Dimension

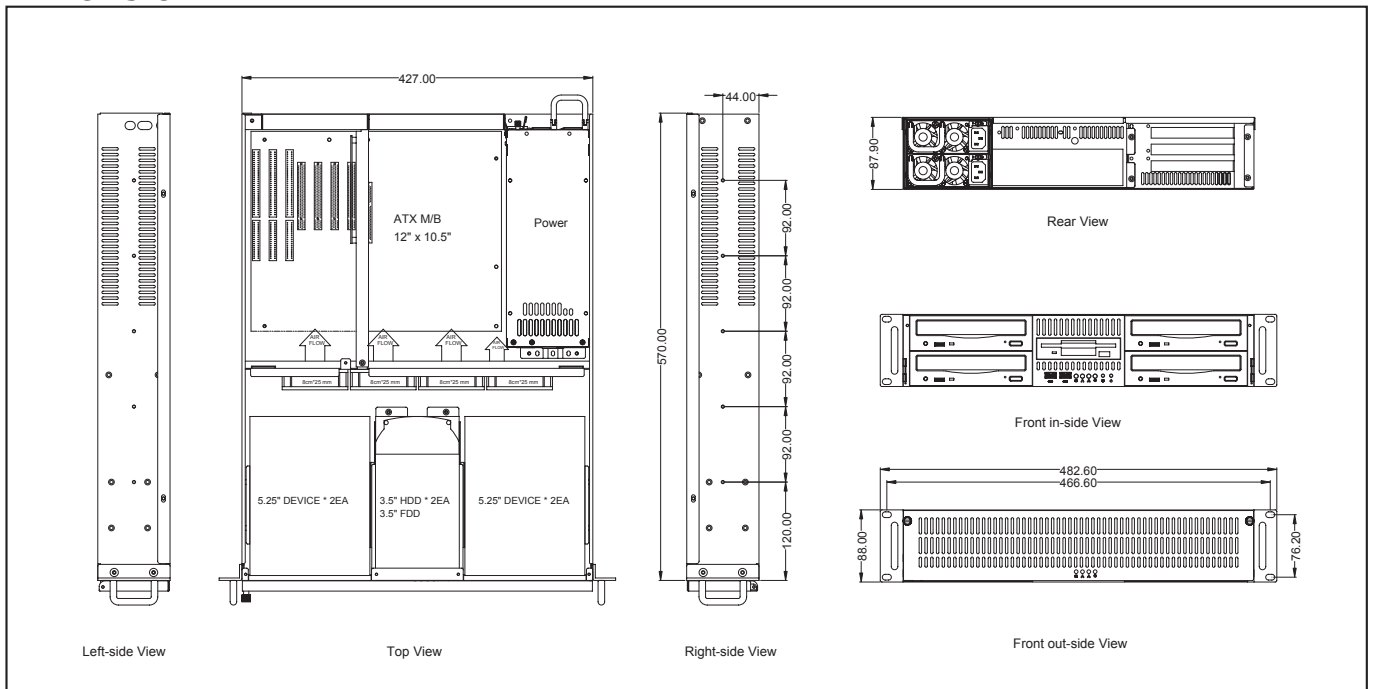

GHI-221

2U Rackmount Chassis

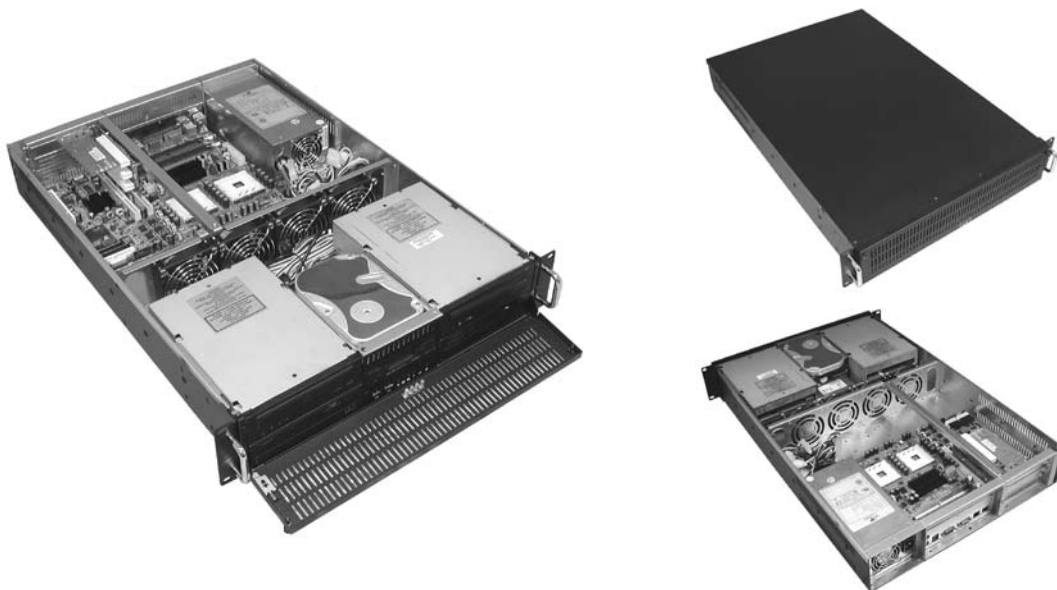

Specifications

- **EIA RS-310C 19" Rackmount Standard**
- **Construction:** Heavy Duty Cold Rolled Electroplated Steel
- **Color:** Black (Standard), Beige or Custom
- **System Boards:** Pentium 4, Dual Xeon, Athlon 64, Dual Opteron
- **Support EATX M/B (Max. to 12" x 13") SSI EEB3.0**
- **Drive Capacity:** 4x 5.25" & 2x 3.5"HDD & 1x 3.5"FDD or 6 Storage Module & 2x 3.5"HDD & 1x 3.5"FDD
- **Power Supply (Optional):** 2U Single up to 510W or Redundant up to 400W ATX P/S (Rear Installation) Max. Depth 300mm
- **Cooling:** 4x (80mm = 42.5CFM ea.)
- **Front Door:** Single Door With 2 Thumbscrew and Removeable Door
- **Connector Port (Front):** 2 x USB Ports
- **Indicators:** LEDs for Power ON/OFF, HDD Activity , 2x LAN
- **Switch:** Power ON/OFF Momentary (Dimple), System Reset
- **Dimensions (W x H x D):** 483 x 88 x 650mm (19" x 3.5" x 25.6")
- **Cuft:** 4.4
- **GW:** 14.9 kgs / 32.9 lbs
- **Carton Size(cm):** 58.8 x 25.5 x 82.5 (23.2" x 10" x 32.5")
- **Humidity:** 5% - 95% Non-condensing

Dimension

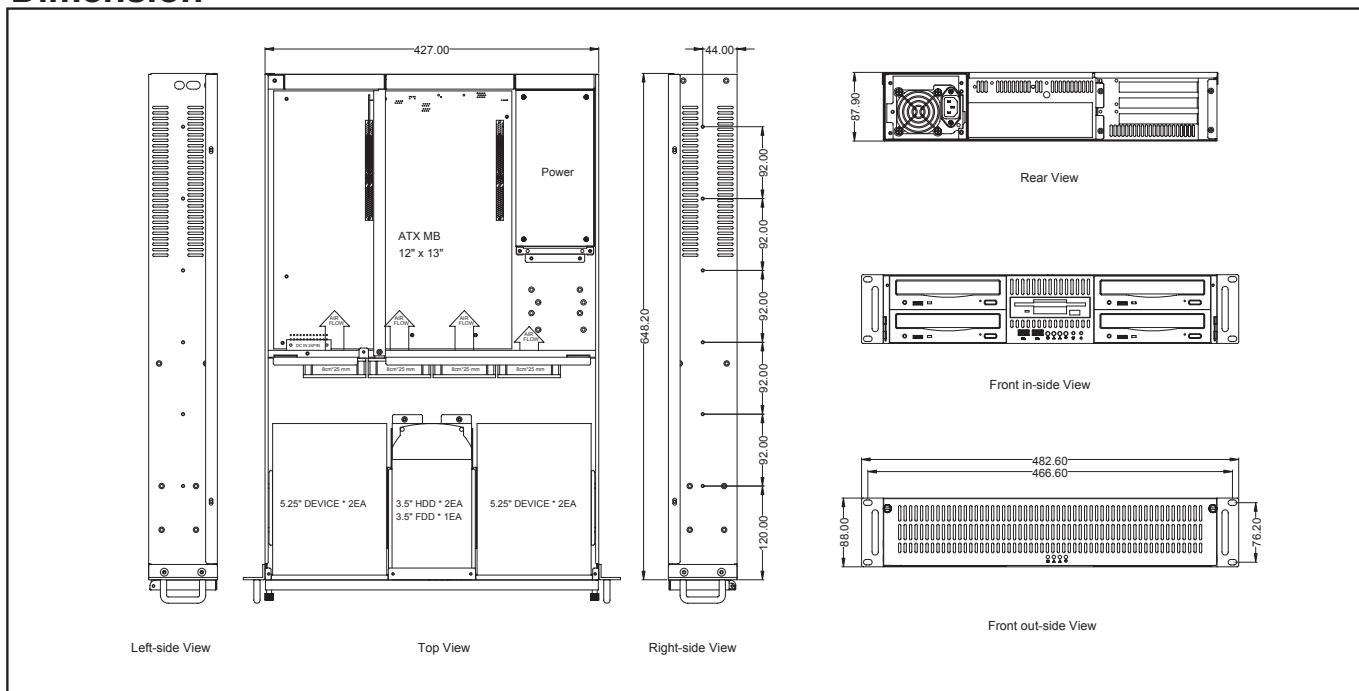

GH-231ATX

2U Rackmount Chassis



19" Rackmount

Specifications

- **EIA RS-310C 19" Rackmount Standard**
- **Construction:** Heavy Duty Cold Rolled Electroplated Steel
- **Color:** Black (Standard), Beige or Custom
- **System Boards:** Pentium 4, Athlon 64, Opteron
- **Support EATX M/B (Max. to 12" x 13")**
- **Drive Capacity:** 2x 5.25" & 2x 3.5" & 3x 3.5" HDD
- **Power Supply (Optional):** 2U Single up to 400W or Redundant up to 350W ATX P/S (Rear Installation) Max. Depth 300mm
- **Cooling:** 3x (80mm = 42.5CFM ea.) Fans
- **Front Door:** Single Door with 1 Thumb Twist Keylock
- **Connector Port (Front):** 2 x USB Ports (Optional)
- **Riser Card:** Please Check Page 194-196 For Optional 2U Riser Card
- **Expansion Slots(Optional):** 2 or 3x Horizontal ISA/PCI/AGP Option Slots or 7 Low Profile PCI Slots
- **Indicators:** LEDs for Power ON/OFF, HDD Activity
- **Switch:** Power ON/OFF Momentary (Rocker), System Reset
- **Dimensions (WxHxD):** 483 x 88 x 650mm (19" x 3.5" x 25.6")
- **Cuft:** 4.4
- **GW:** 15 kgs / 33.1 lbs
- **Carton Size(cm):** 58.8 x 25.5 x 82.5(23.1" x 10" x 32.5")
- **Humidity:** 5% - 95% Non-condensing

Dimension

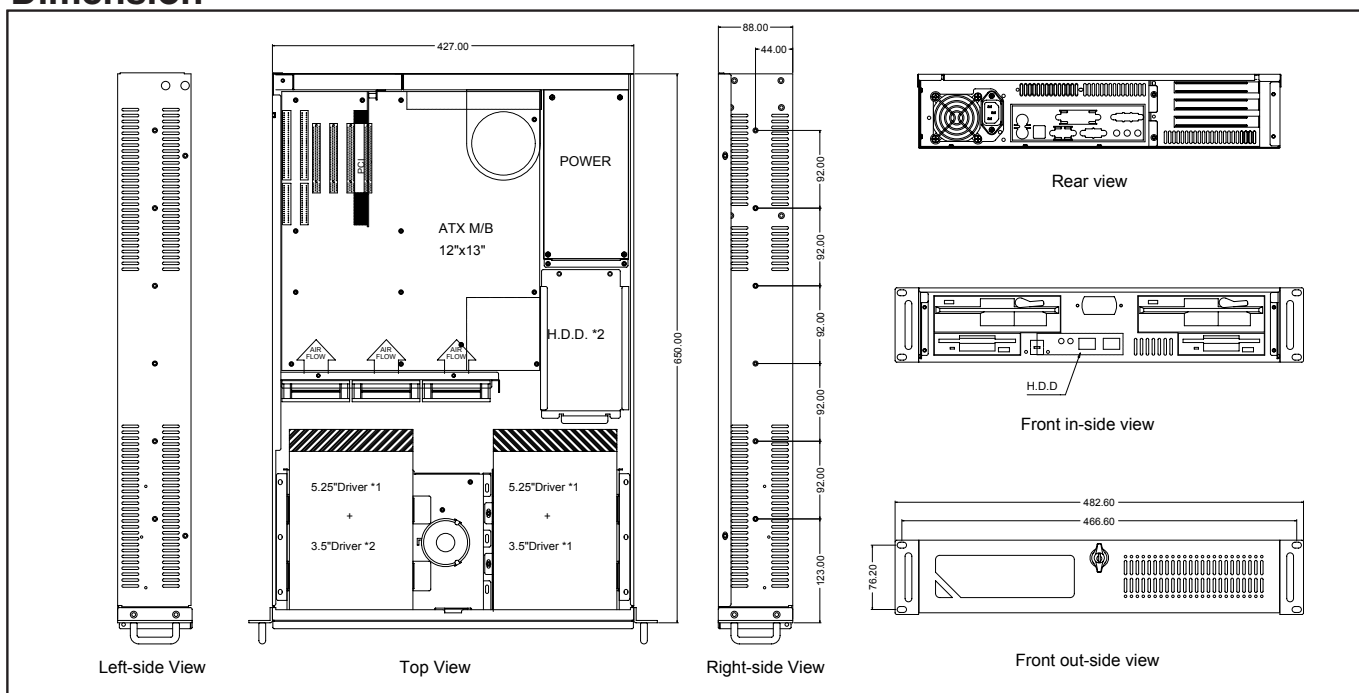

GH-232ATX

2U Rackmount Chassis



Specifications

- **EIA RS-310C 19" Rackmount Standard**
- **Construction:** Heavy Duty Cold Rolled Electroplated Steel
- **Color:** Black (Standard), Beige or Custom
- **System Boards:** Pentium 4, Dual Xeon, Athlon 64, Dual Opteron
- **Support EATX M/B (Max. to 12" x 13")**
- **Drive Capacity:** 1x 5.25" & 1x 3.5" & 5x 3.5" HDD
- **Power Supply (Optional):** PS/2 Size Single up to 460W ATX P/S (Front/Mid Installation) Max. Depth 300mm
- **Cooling:** 1x (60mm = 23.5CFM ea.) & 3x (80mm = 42.5CFM ea.) Fans
- **Air Filter:** Inside Front Panel (Washable)
- **Front Door:** Single Door with 1 Thumb Twist Keylock
- **Connector Port (Front):** 2 x USB Ports (Optional)
- **Riser Card:** Please Check Page 194-196 For Optional 2U Riser Card
- **Expansion Slots(Optional):** 2 or 3x Horizontal ISA/PCI/AGP Option Slots or 7x Low Profile PCI Slots
- **Indicators:** LEDs for Power ON/OFF, HDD Activity
- **Switch:** Power ON/OFF Momentary(Rocker), System Reset
- **Dimensions (WxHxD):** 483x88x650mm(19" x 3.5" x 25.6")
- **Cuft:** 4.4
- **GW:** 15 kgs / 33.1 lbs
- **Carton Size(cm):** 58.8 x 25.5 x 82.5 (23.1" x 10" x 32.5")
- **Humidity:** 5% - 95% Non-condensing

Dimension

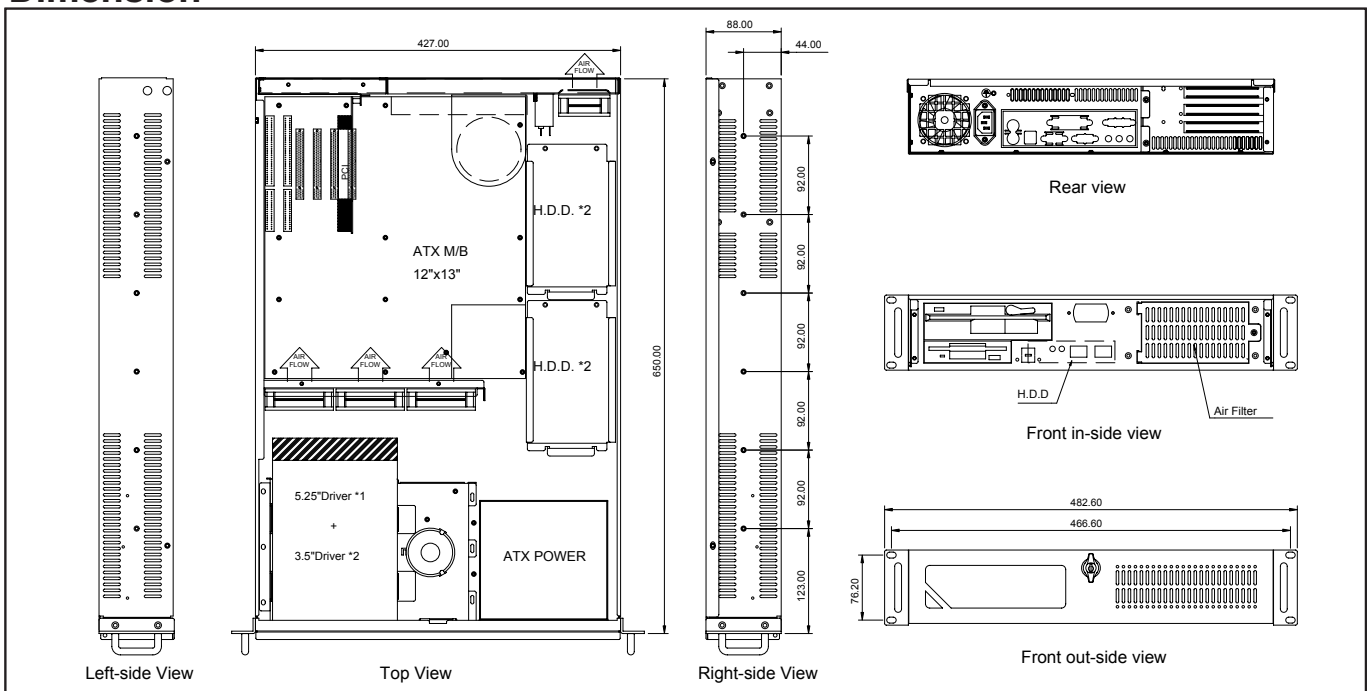

GHI-240

2U Rackmount Chassis

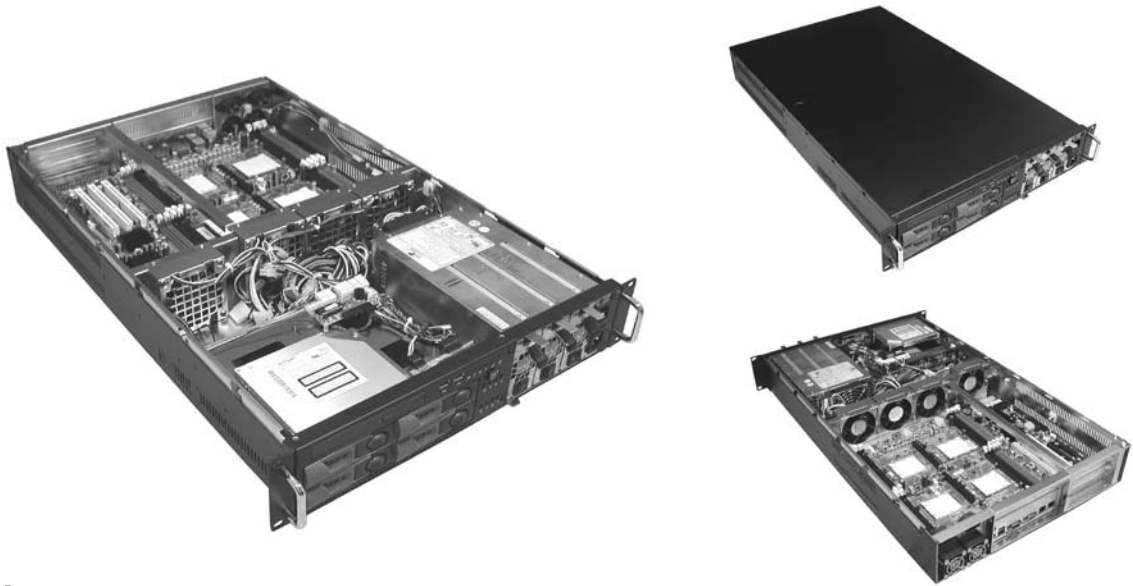

19" Rackmount

Specifications

- **EIA RS-310C 19" Rackmount Standard**
- **Construction:** Heavy Duty Cold Rolled Electroplated Steel
- **Color:** Black (Standard), Beige or Custom
- **System Boards:** Pentium 4, Dual Xeon, Athlon 64, Dual Opteron
- **Support EATX M/B (Max. to 16" x 13") SSI EEB 3.0**
- **Drive Capacity:** 1x Slim CD-ROM & 4x 3.5" Swappable Tray
- **Drive Interface:** PATA, SATA, SCSI320 or SAS
- **Power Supply (Optional):** 2U Redundant up to 750W (Front Installation)
- **Cooling:** 4x (80mm = 42.5CFM ea.) & 2x (40x28mm = 15.3CFM ea.) Fans
- **Riser Card:** Please Check Page 194-196 For Optional 2U Riser Card
- **Connector Port (Front):** 2x USB Ports
- **Thermal Management Card:** GHA-CO04
- **Indicators:** LEDs for Power ON/OFF, HDD Activity, Fan, Temperature
- **Switch:** Power ON/OFF Momentary (Pushbutton), System Reset, Buzzer Reset
- **Dimensions (W x H x D):** 483 x 88 x 710mm (19" x 3.5" x 28")
- **Cuft:** 4.4
- **GW:** 16.3 kgs / 36.0 lbs
- **Carton Size(cm):** 57 x 24 x 90.5 (22.4" x 9.5" x 35.6")
- **Humidity:** 5% - 95% Non-condensing

Dimension

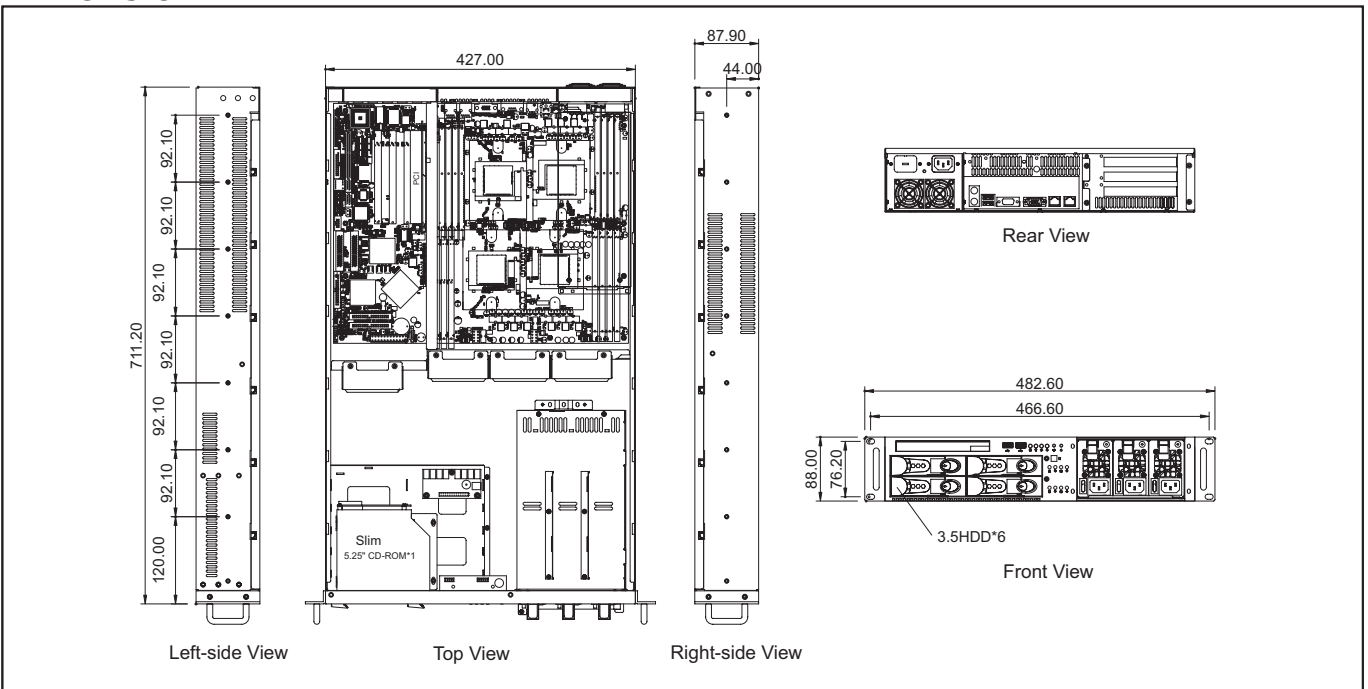

GHI-243

2U Rackmount Chassis

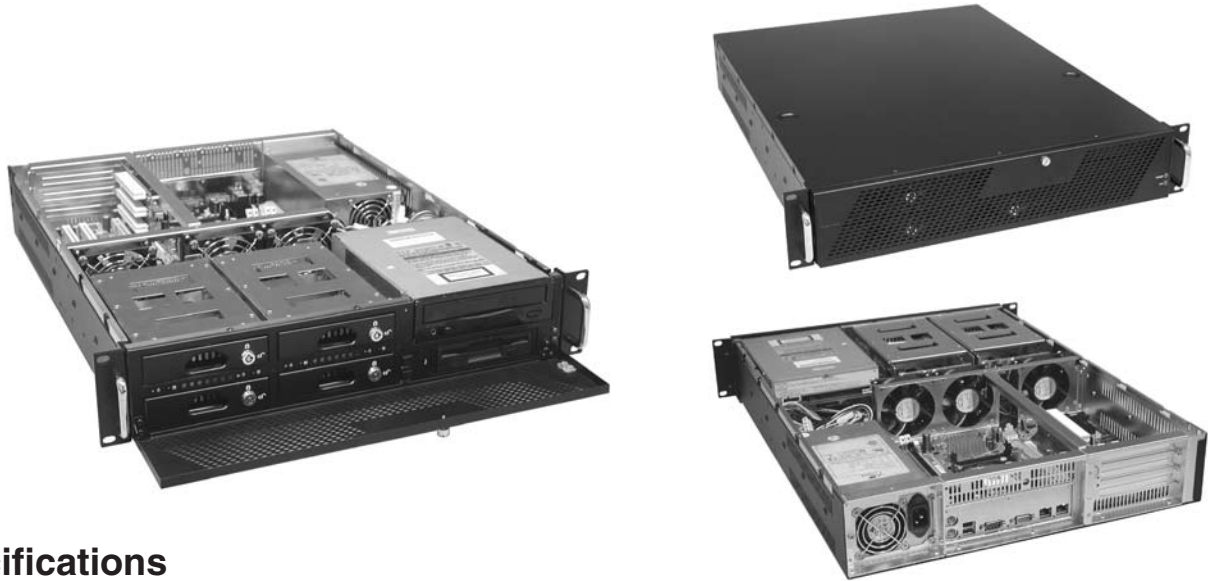

Specifications

- **EIA RS-310C 19" Rackmount Standard**
- **Construction:** Heavy Duty Cold Rolled Electroplated Steel
- **Color:** Black (Standard), Beige or Custom
- **System Boards:** Dual Xeon, Pentium 4, Dual Pentium III
- **Support ATX M/B(Max. to 12"x10.5")**
- **Drive Capacity:** 1x 5.25" CD-ROM & 1x 3.5"FDD/HDD & 4x 3.5" Swappable Drive Trays With Keylock
- **Drive Interface:** P-ATA ,SCSI , S-ATA or SAS
- **Power Supply(Optional):** 2U Single up to 600W or Redundant up to 500W ATX P/S (Rear Installation) Max. Depth 300mm
- **Cooling:** 3x (80mm = 42.5CFM ea.)
- **Front Door:** Single Door With One Thumbscrew (Removable)
- **Connector Port (Front):** 1x USB Port (Optional)
- **Expansion Slots(Optional):** 2 or 3x Horizontal Slots (ISA, PCI, AGP Option) or 7x Low Profile PCI Slots
- **Indicators:** LEDs for Power ON/OFF, HDD Power/Access, LAN
- **Switch:** Power ON/OFF, System Reset
- **Dimensions (W x H x D):** 480 x 88 x 558mm (18.9" x 3.5" x 22")
- **Cuft:** 3.3
- **GW:** 14.3 kgs / 31.5 lbs
- **Carton Size(cm):** 57 x 22 x 73.5 (22.4" x 8.7" x 28.9")
- **Humidity:** 5% - 95% Non-condensing

Dimension

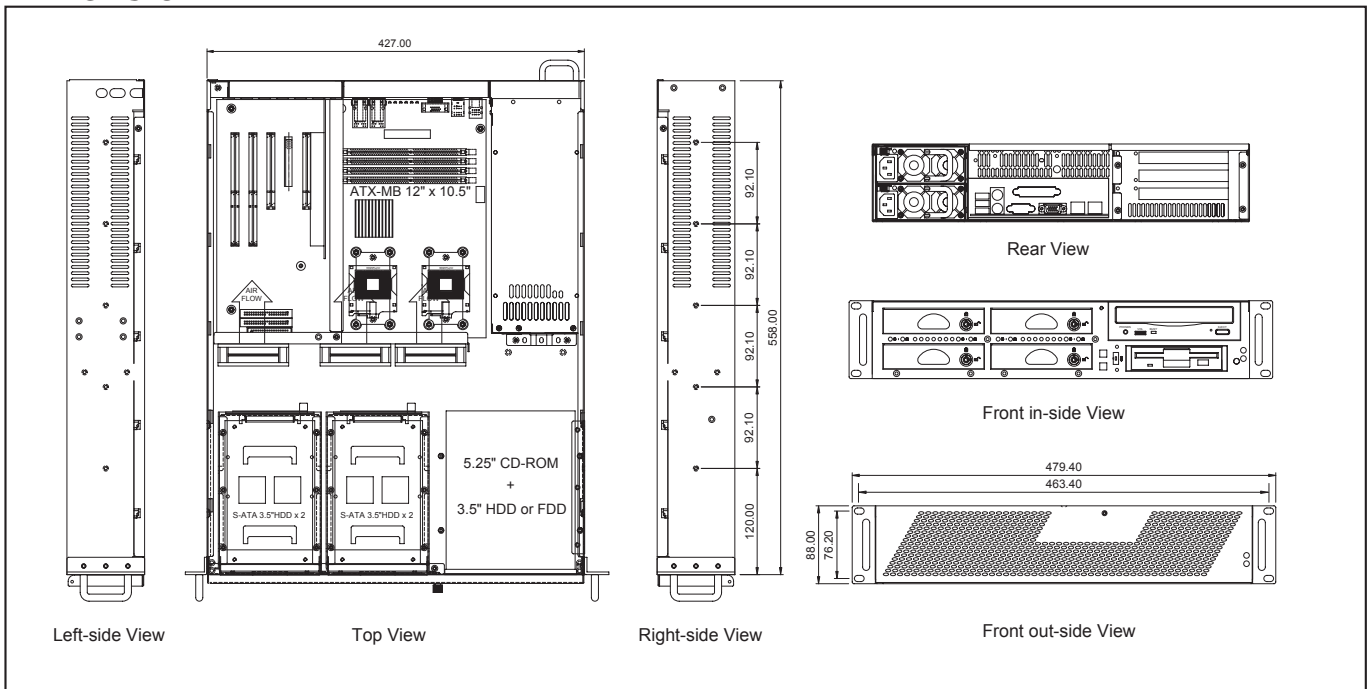

GHI-246

2U Rackmount Chassis

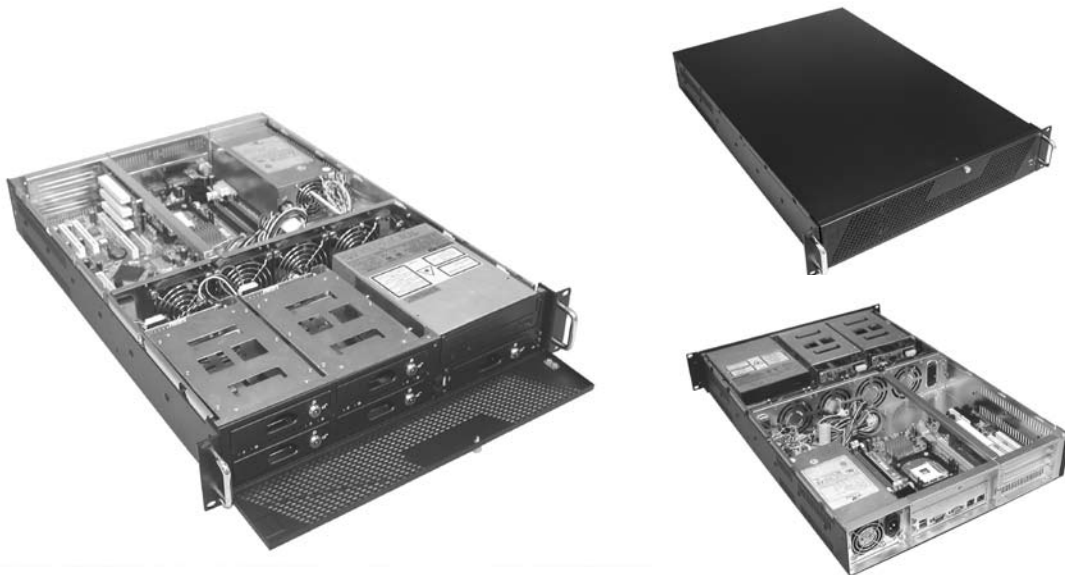

19" Rackmount

Specifications

- **EIA RS-310C 19" Rackmount Standard**
- **Construction:** Heavy Duty Cold Rolled Electroplated Steel
- **Color:** Black (Standard), Beige or Custom
- **System Boards:** Dual Xeon, Pentium 4, Dual Pentium III
- **Support EATX M/B(Max. to 12"x13")**
- **Drive Capacity:** 1x5.25" CD-ROM & 4x3.5" Swappable Drive Trays & 1x 3.5" Swappable Drive Trays (Optional)
- **Drive Interface:** P-ATA ,SCSI , S-ATA or SAS
- **Power Supply(Optional):** 2U Single up to 600W or 2U Redundant up to 500W ATX P/S (Rear Installation)
- **Max. Depth** 300mm
- **Cooling:** 4x (80mm = 42.5CFM ea.) Fans
- **Front Door:** Single Door With One Thumbscrew (Removable)
- **Connector Port (Front):** 1x USB Port
- **Expansion Slots(Optional):** 2 or 3x Horizontal Slots(ISA, PCI, AGP Option) or 7x Low Profile PCI Slots
- **Indicators:** LEDs for Power ON/OFF, HDD Power/Access, LAN
- **Switch:** Power ON/OFF, System Reset
- **Dimensions (W x H x D):** 480 x 88 x 650mm (18.9"x3.5"x25.6")
- **Cuft:** 4.4
- **GW:** 15.5 kgs / 34.2 lbs
- **Carton Size(cm):** 58.8 x 25.5 x 82.5(23.1" x 10" x 32.5")
- **Humidity:** 5% - 95% Non-condensing

Dimension

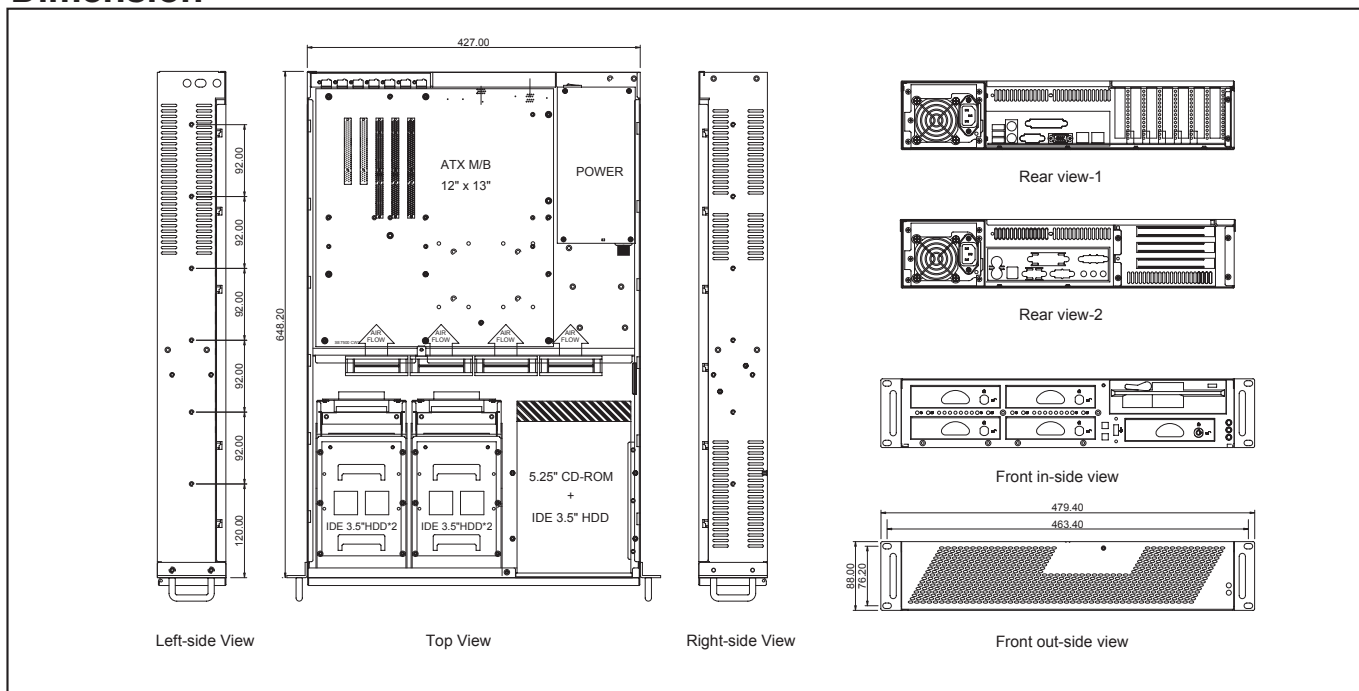

GHI-247

2U Rackmount Chassis

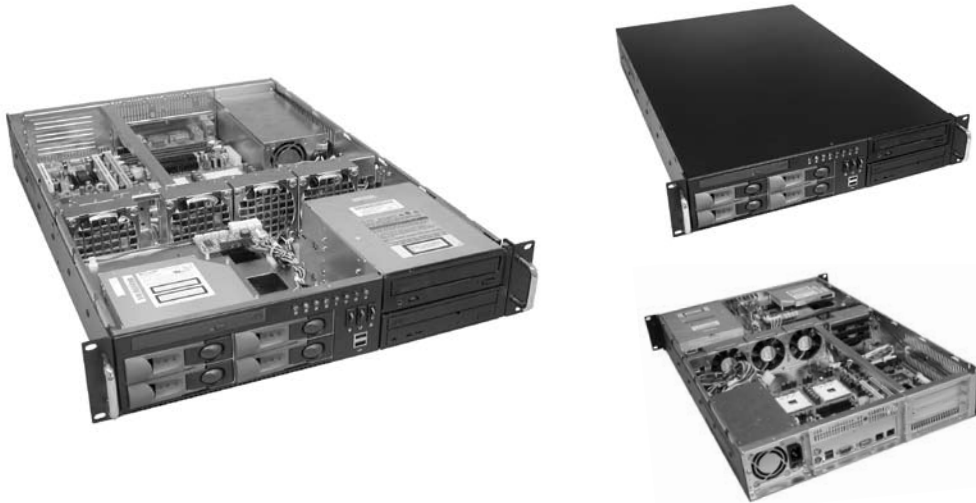

Specifications

- **EIA RS-310C 19" Rackmount Standard**
- **Construction:** Heavy Duty Cold Rolled Electroplated Steel
- **Color:** Black (Standard), Beige or Custom
- **System Boards:** Pentium 4, Dual Xeon, Athlon 64, Dual Opteron
- **Support EATX M/B (Max. to 12" x 13") SSI EEB 3.0**
- **Drive Capacity:** 2x 5.25" & 1x 5.25" Slim CD-ROM & 4x 3.5" Swappable Trays
- **Drive Interface:** PATA, SATA, SCSI320 or SAS
- **Power Supply (Optional):** 2U Single up to 600W or 2U Redundant up to 500W ATX P/S(Rear Installation) Max. Depth 300mm
- **Cooling:** 4x (80mm = 42.5CFM ea.) Fans
- **Riser Card:** Please Check Page 194-196 For Optional 2U Riser Card
- **Connector Port (Front):** 2x USB Ports
- **Thermal Management Card:** GHA-CO04
- **Indicators:** LEDs for Power ON/OFF, HDD Activity, Fan, Temperature
- **Switch:** Power ON/OFF Momentary (Rocker), System Reset
- **Dimensions (W x H x D):** 483 x 88 x 650mm (19" x 3.5" x 25.6")
- **Cuft:** 4.4
- **GW:** 15.3 kgs / 33.7 lbs
- **Carton Size(cm):** 58.8 x 25.5 x 82.5 (23.1" x 10" x 32.5")
- **Humidity:** 5% - 95% Non-condensing

Dimension

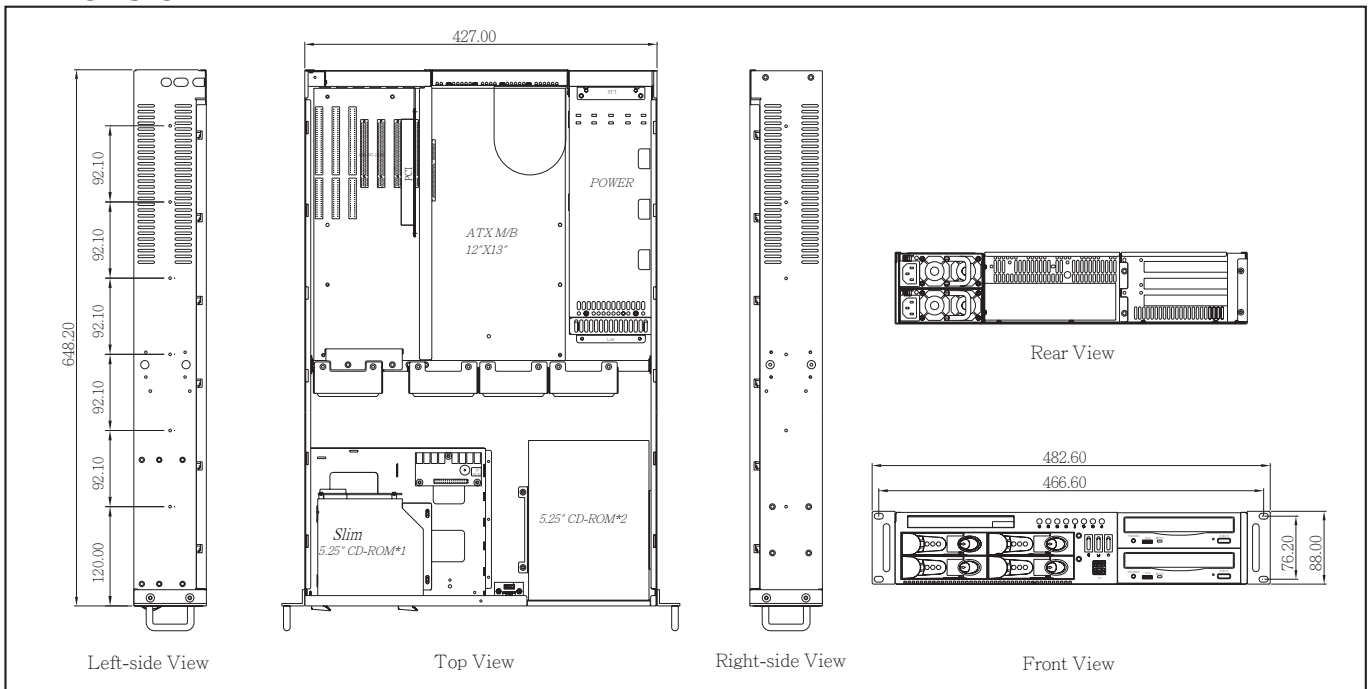

GHI-248

2U Rackmount Chassis



19" Rackmount

Specifications

- **EIA RS-310C 19" Rackmount Standard**
- **Construction:** Heavy Duty Cold Rolled Electroplated Steel
- **Color:** Black (Standard), Beige or Custom
- **System Boards:** Pentium 4, Dual Xeon, Athlon 64, Dual Opteron
- **Support EATX M/B (Max. to 12" x 10.5")**
- **Drive Capacity:** 4x 5.25" & 2x 2.5"HDD
- **Power Supply (Optional):** 2U Single up to 510W or Redundant up to 400W ATX P/S (Rear Installation) Max. Depth 265mm
- **Cooling:** 3x (80mm = 42.5CFM ea.) Fans
- **Front Door:** Two Horizontal Doors with 1 Keylock
- **Air Filter:** Inside Front Door (Washable)
- **Riser Card:** Please Check Page 194-196 For Optional 2U Riser Card
- **Connector Port (Front):** 2x USB Ports
- **Expansion Slots(Optional):** 3x Horizontal or 7x Low Profile PCI Slots
- **Indicators:** LEDs for Power ON/OFF, HDD Activity
- **Switch:** Power ON/OFF , System Reset
- **Dimensions (W x H x D):** 483 x 88 x 570mm (19" x 3.5" x 22.4")
- **Cuft:** 2.9
- **GW:** 13 kgs / 28.7 lbs
- **Carton Size(cm):** 56.2 x 20.3 x 71.3 (22.1" x 8" x 28.1")
- **Humidity:** 5% - 95% Non-condensing

Dimension

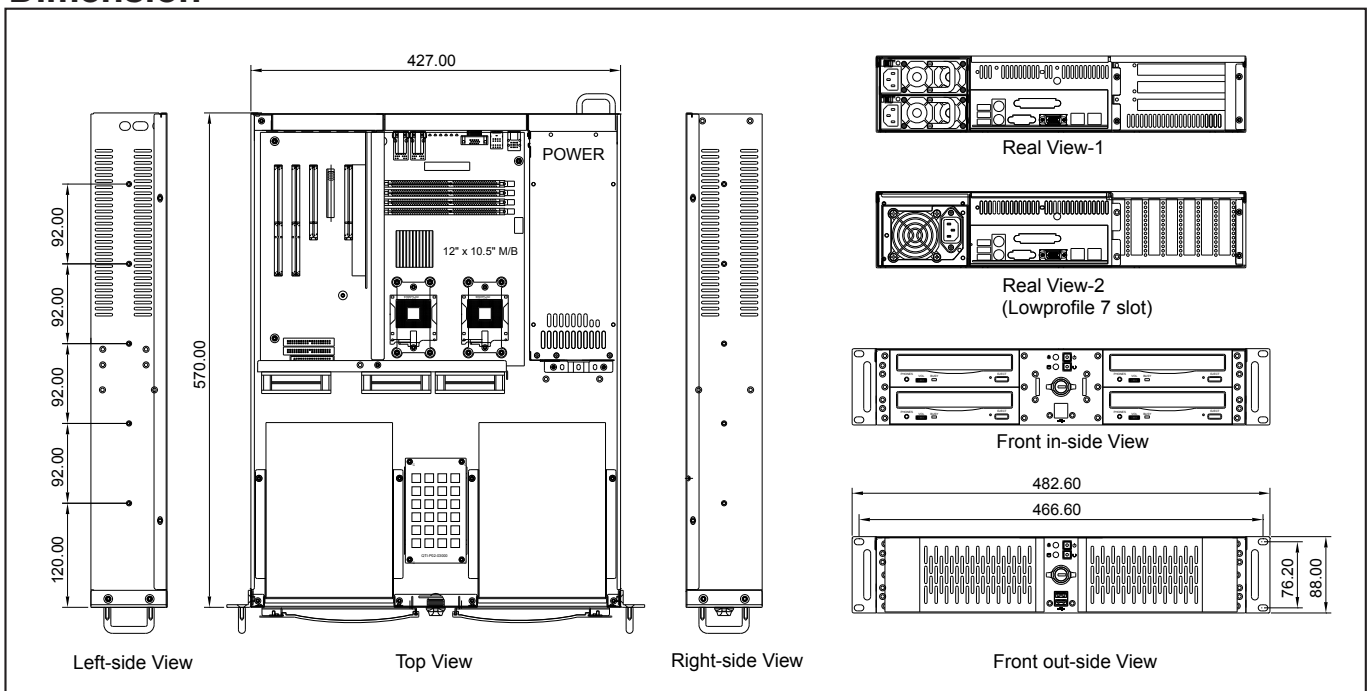

GHI-249

2U Rackmount Chassis



Specifications

- **EIA RS-310C 19" Rackmount Standard**
- **Construction:** Heavy Duty Cold Rolled Electroplated Steel
- **Color:** Black (Standard), Beige or Custom
- **System Boards:** Pentium 4, Dual Xeon, Athlon 64, Dual Opteron
- **Support EATX M/B (Max. to 12" x 13") SSI EEB 3.0**
- **Drive Capacity:** 4x 3.5" Swappable Trays, 1x Slim FDD, 1x Slim CD-ROM
- **Drive Interface:** SATA or SAS
- **Power Supply (Optional):** 2U Single up to 600W or 2U Redundant up to 500W ATX P/S(Rear Installation) Max. Depth 300mm
- **Cooling:** 4x (80mm = 42.5CFM ea.) Fans
- **Front Door:** Two Horizontal Doors With 1 Keylock
- **Air Filter:** Inside Front Door (Washable)
- **Riser Card:** Please Check Page 194-196 For Optional 2U Riser Card
- **Expansion Slots(Optional):** 3x Horizontal or 7x Low Profile PCI Slots
- **Connector Port (Front):** 2x USB Ports
- **Indicators:** LEDs for Power ON/OFF, HDD Power/Access
- **Switch:** Power ON/OFF Momentary (Pushbutton), System Reset
- **Dimensions (W x H x D):** 483 x 88 x 650mm (19" x 3.5" x 25.6")
- **Cuft:** 4.4
- **GW:** 16.1 kgs / 35.5 lbs
- **Carton Size(cm):** 58.8 x 25.5 x 82.5 (23.1" x 10" x 32.5")
- **Humidity:** 5% - 95% Non-condensing

Dimension

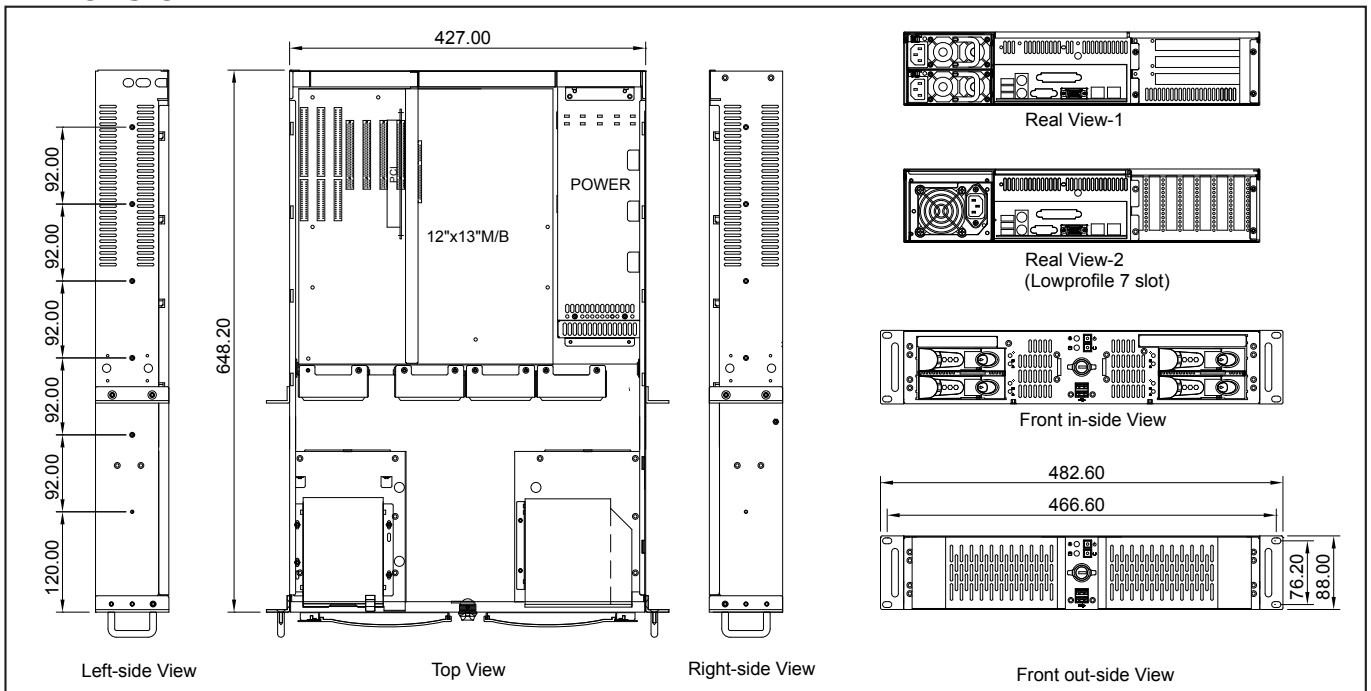

GHI-250

2U Rackmount Chassis



Specifications

- **EIA RS-310C 19" Rackmount Standard**
- **Construction:** Heavy Duty Cold Rolled Electroplated Steel
- **Color:** Black (Standard), Beige or Custom
- **System Boards:** Pentium 4, Athlon 64
- **Support ATX M/B (Max. to 12" x 9.6")**
- **Drive Capacity:** 1x 5.25" & 1x Slim FDD (On Rear) & 1x 3.5" HDD
- **Power Supply (Optional):** 1U Single up to 300W ATX P/S(Mid Installation) Max. Depth 190mm
- **Cooling:** 2x (80mm = 42.5CFM ea.) Fans
- **Expansion Slots:** 5x Low Profile PCI Slots
- **Indicators:** LEDs for Power ON/OFF, LAN, HDD Activity
- **Switch:** Power ON/OFF Momentary (Square), System Reset
- **Dimensions (WxHxD):** 483 x 88 x 355mm (19" x 3.5" x 13.9")
- **Cuft:** 2.0
- **GW:** 9.0 kgs / 19.8 lbs
- **Carton Size(cm):** 57 x 20.3 x 50 (22.4" x 8" x 19.7")
- **Humidity:** 5% - 95% Non-condensing

Dimension

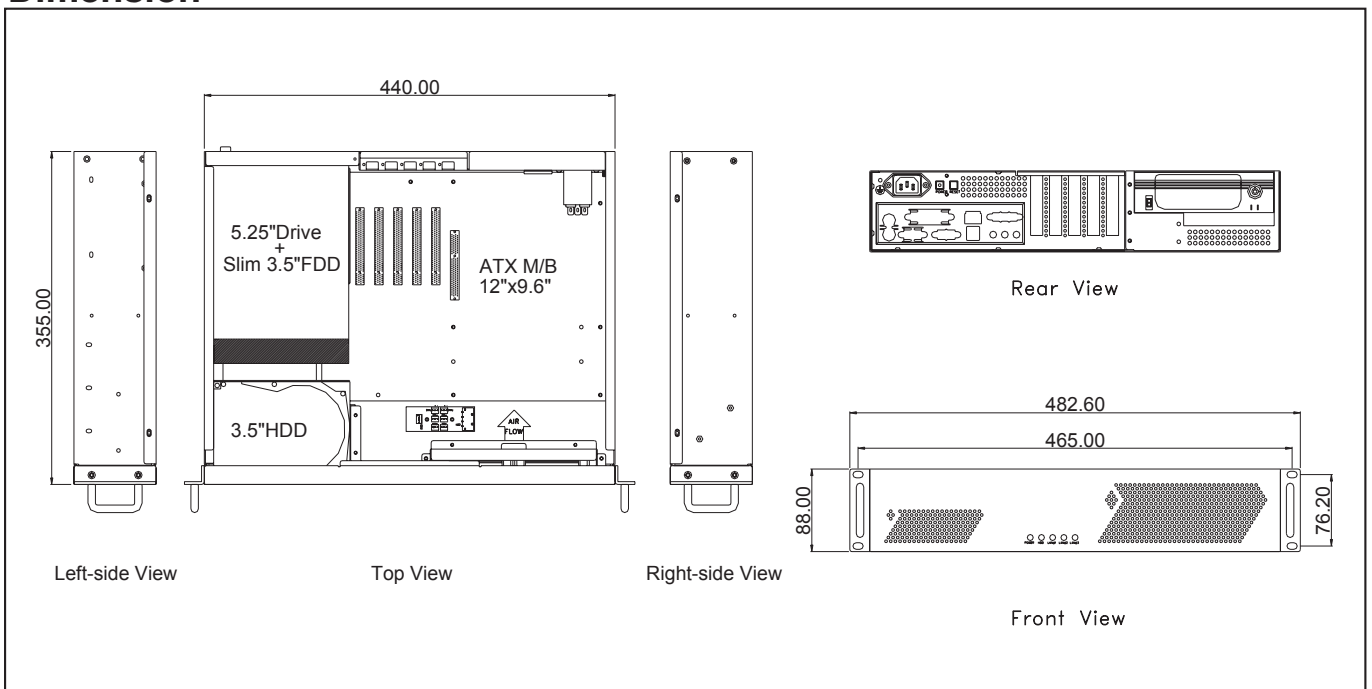

GHI-251

2U Rackmount Chassis



Specifications

- **EIA RS-310C 19" Rackmount Standard**
- **Construction:** Heavy Duty Cold Rolled Electroplated Steel
- **Color:** Black (Standard), Beige or Custom
- **System Boards:** Pentium 4, Athlon 64
- **Support ATX M/B (Max. to 12" x 9.6")**
- **Drive Capacity:** 1x 5.25" & 2x 3.5" HDD
- **Power Supply (Optional):** 1U Single up to 300W ATX P/S(Rear Installation) Max. Depth 205mm
- **Cooling:** 2x (80mm = 42.5CFM ea.) & 2x (40x 28mm = 15CFM ea.)(Optional) Fans
- **Connector Port (Front):** 2x USB Ports
- **Expansion Slots:** 7x Low Profile PCI Slots
- **Indicators:** LEDs for Power ON/OFF, LAN, HDD Activity
- **Switch:** Power ON/OFF Momentary (Square), System Reset
- **Dimensions (WxHxD):** 483 x 88 x 355mm (19" x 3.5" x 13.9")
- **Cuft:** 2.0
- **GW:** 8.4 kgs / 18.5 lbs
- **Carton Size(cm):** 57 x 20.3 x 50 (22.4" x 8" x 19.7")
- **Humidity:** 5% - 95% Non-condensing

Dimension

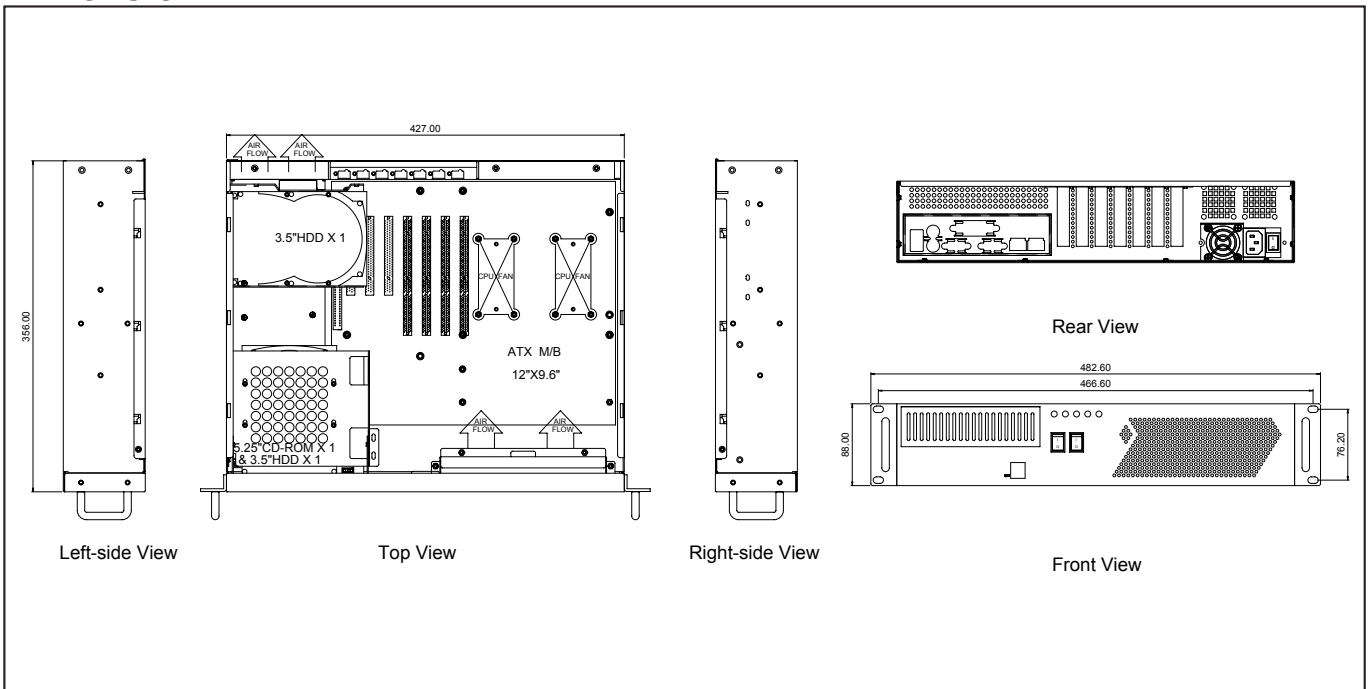

GHI-252V/252H

2U Rackmount Chassis



19" Rackmount

Specifications

- **EIA RS-310C 19" Rackmount Standard**
- **Construction:** Heavy Duty Cold Rolled Electroplated Steel
- **Color:** Black (Standard), Beige or Custom
- **System Boards:** Pentium 4, Athlon 64
- **Support ATX M/B (Max. to 12" x 9.6")**
- **Drive Capacity:** 1x 5.25" & 1x Slim FDD & 3x 3.5" HDD
- **Power Supply (Optional):** 1U Single up to 300W ATX P/S (Rear Installation) Max. Depth 205mm
- **Cooling:** 1x (80mm = 42.5CFM ea.) & 2x (40 x 20mm = 7CFM ea) Fans
- **Riser Card:** Please Check Page 194-196 For Optional 2U Riser Card
- **Connector Port (Front):** 2x USB Ports
- **Expansion Slots(Optional):** 2 or 3x Horizontal ISA/PCI/AGP Option Slots(GHI-252H) or 7x Low Profile PCI Slots (GHI-252V)
- **Indicators:** LEDs for Power ON/OFF, LAN, HDD Activity
- **Switch:** Power ON/OFF Momentary(Square), System Reset
- **Dimensions (WxHxD):** 483 x 88 x 357mm (19" x 3.5" x 14.1")
- **Cuft:** 2.0
- **GW:** 9.0kgs / 19.8lbs
- **Carton Size(cm):** 57 x 20.3 x 50 (22.4" x 8" x 19.7")
- **Humidity:** 5% - 95% Non-condensing

Dimension

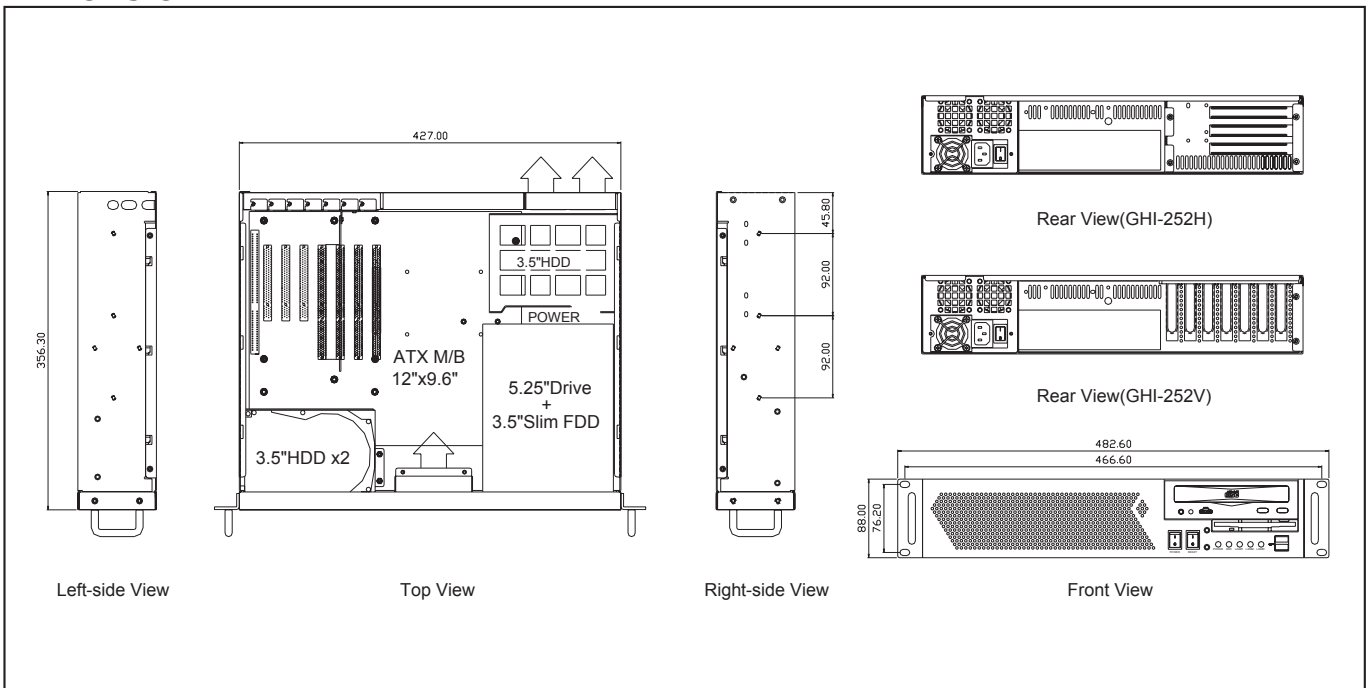

GHI-253H/253V

2U Rackmount Chassis

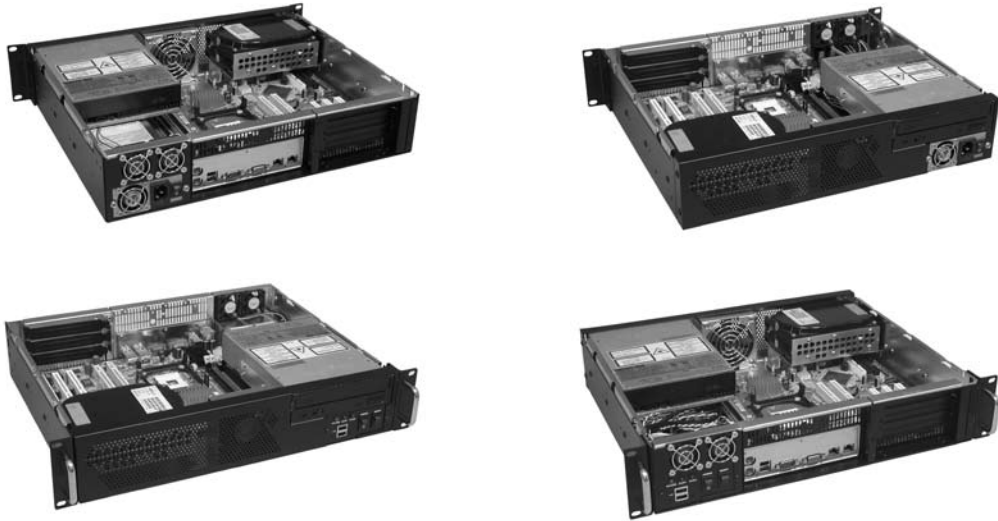

Specifications

- **EIA RS-310C 19" Rackmount Standard**
- **Construction:** Heavy Duty Cold Rolled Electroplated Steel
- **Color:** Black (Standard), Beige or Custom
- **System Boards:** Pentium 4, Athlon 64
- **Support ATX M/B (Max. to 12" x 9.6")**
- **Drive Capacity:** 1x 5.25" & 2x 3.5" HDD
- **Power Supply (Optional):** 1U Single up to 300W ATX P/S (Rear Installation) Max. Depth 205mm
- **Changeable Front and Rear Rackmount**
- **Cooling:** 1x (80mm = 42.5CFM ea.) & 2x (40 x 20mm = 7CFM ea) Fans
- **Riser Card:** Please Check Page 194-196 For Optional 2U Riser Card
- **Connector Port (Front):** 2x USB Ports
- **Expansion Slots(Optional):** 2 or 3x Horizontal ISA/PCI/AGP Option Slots(GHI-253H) or 7x Low Profile PCI Slots(GHI-253V)
- **Indicators:** LEDs for Power ON/OFF, LAN, HDD Activity
- **Switch:** Power ON/OFF Momentary (Square), System Reset
- **Dimensions (W x H x D):** 483 x 88 x 357mm (19" x 3.5" x 14.1")
- **Cuft:** 2.0
- **GW:** 8.0 kgs / 17.6 lbs
- **Carton Size(cm):** 57 x 20.3 x 50 (22.4" x 8" x 19.7")
- **Humidity:** 5% - 95% Non-condensing

Dimension

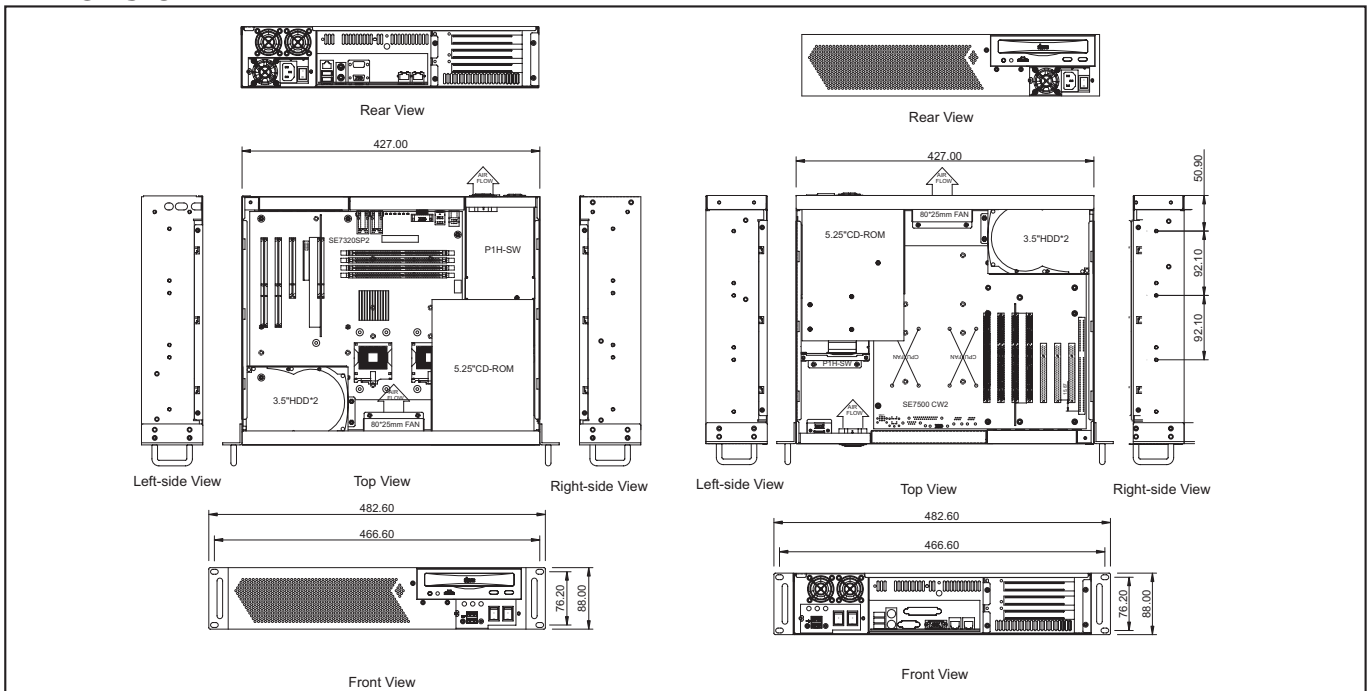

GHI-254

2U Rackmount Chassis



19" Rackmount

Specifications

- **EIA RS-310C 19" Rackmount Standard**
- **Construction:** Heavy Duty Cold Rolled Electroplated Steel
- **Color:** Black (Standard), Beige or Custom
- **System Boards:** Pentium 4, Athlon 64
- **Support Micro ATX (Max. to 9.6" x 9.6")**
- **Drive Capacity:** 1x 5.25" Slim-CD-ROM & 2x 3.5" HDD & 2x 3.5" Swappable Trays
- **Power Supply (Optional):** PS/2 Size Single up to 400W
ATX P/S Max. Depth 150mm
- **Cooling:** 1x (80mm = 42.5CFM ea.)
- **Connector Port (Front):** 2x USB Ports
- **Expansion Slots:** 4x Low Profile PCI Slots
- **Indicators:** LEDs for Power ON/OFF, LAN, HDD Activity
- **Switch:** Power ON/OFF Momentary (Rocker), System Reset
- **Dimensions (W x H x D):** 483 x 88 x 383mm (19" x 3.5" x 15.1")
- **Cuft:** 2.4
- **GW:** 9.5 kgs / 21.0 lbs
- **Carton Size(cm):** 57 x 22 x 53.5 (22.4" x 8.7" x 21.1")
- **Humidity:** 5% - 95% Non-condensing

Dimension

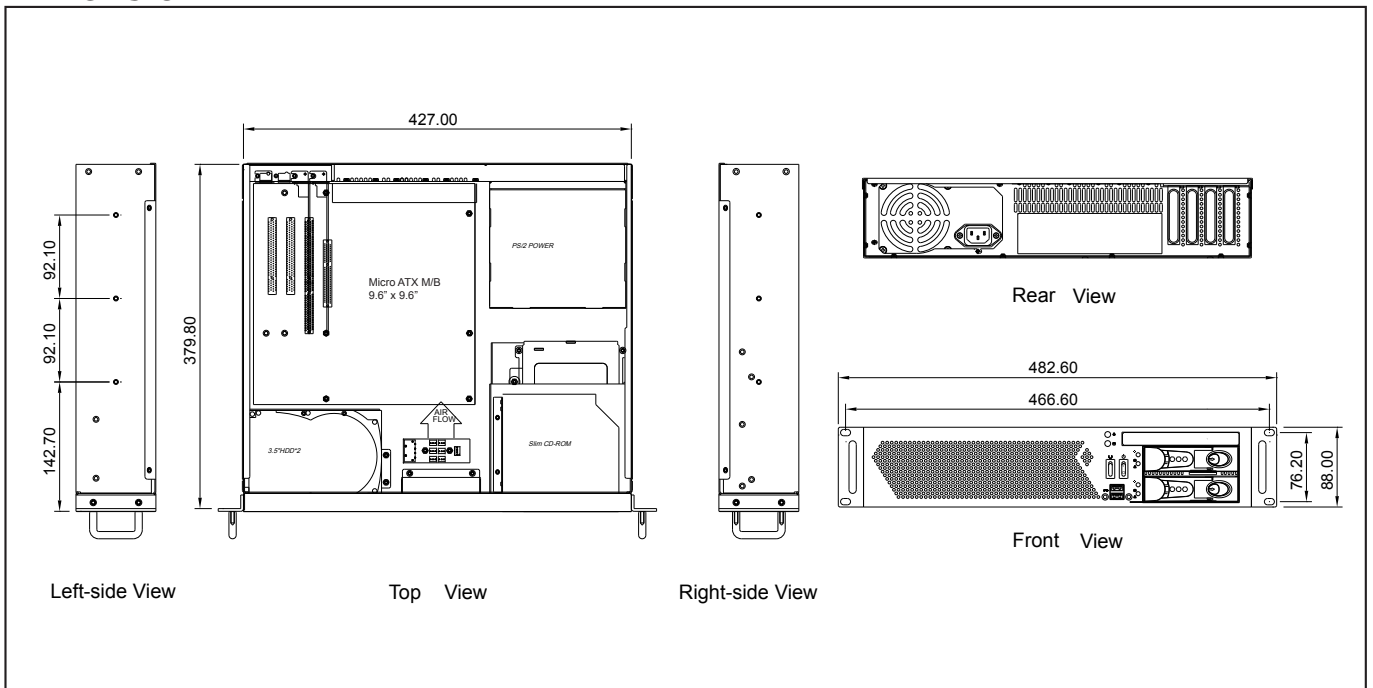

GHI-255

2U Rackmount Chassis



Specifications

- **EIA RS-310C 19" Rackmount Standard**
- **Construction:** Heavy Duty Cold Rolled Electroplated Steel
- **Color:** Black (Standard), Beige or Custom
- **System Boards:** Pentium 4, Athlon 64
- **Support Micro ATX (Max. to 9.6" x 9.6")**
- **Drive Capacity:** 1x 5.25" & 2x 3.5" HDD
- **Power Supply (Optional):** PS/2 Size Single up to 400W ATX
P/S Max. Depth 150mm
- **Cooling:** 1x (80mm = 42.5CFM ea.)
- **Connector Port (Front):** 2x USB Ports
- **Expansion Slots:** 4x Low Profile PCI Slots
- **Indicators:** LEDs for Power ON/OFF, HDD Activity
- **Switch:** Power ON/OFF Momentary (Rocker), System Reset
- **Dimensions (W x H x D):** 483 x 88 x 383mm (19" x 3.5" x 15.1")
- **Cuft:** 2.4
- **GW:** 8.8 kgs / 19.4 lbs
- **Carton Size(cm):** 57 x 22 x 53.5 (22.4" x 8.7" x 21.1")
- **Humidity:** 5% - 95% Non-condensing

Dimension

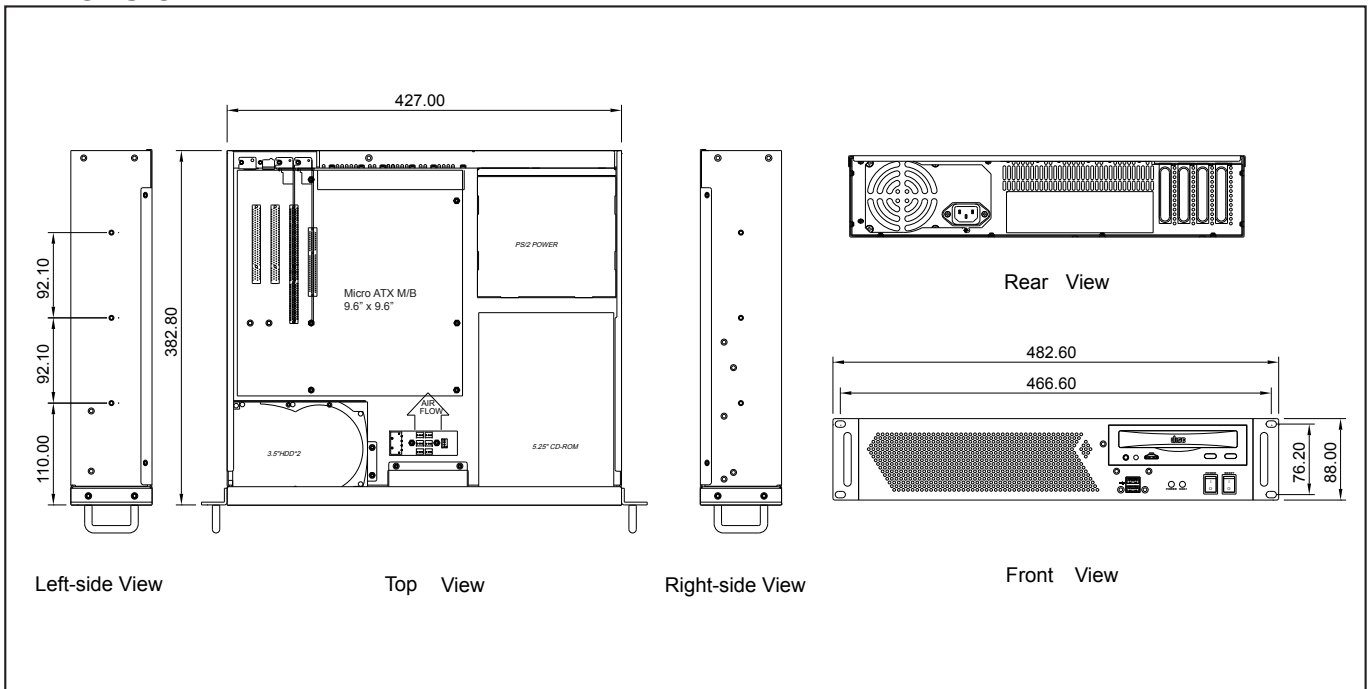

GHI-260

2U Rackmount Chassis



Specifications

- **EIA RS-310C 19" Rackmount Standard**
- **Construction:** Heavy Duty Cold Rolled Electroplated Steel
- **Color:** Black (Standard), Beige or Custom
- **System Boards:** Pentium 4, Dual Xeon, Athlon 64, Dual Opteron
- **Support EATX M/B (Max. to 12" x 13") SSI EEB 3.0**
- **Drive Capacity:** 16x Hot Swap 2.5" Drive Tray & 1x 5.25" CD-ROM
- **Drive Interface:** SATAII, SCSI320 or SAS
- **Power Supply (Optional):** 2U Single up to 600W or Redundant up to 500W ATX P/S (Rear Installation) Max. Depth 300mm
- **Cooling:** 4x (80mm = 42.5CFM ea.) Fans
- **Front Door:** Single Door With 2 Thumbscrews (Removable)
- **Riser Card:** Please Check Page 194-196 For Optional 2U Riser Card
- **Connector Port (Front):** 2x USB Ports
- **Thermal Management Card:** GHA-CO04
- **Indicators:** LEDs for Power ON/OFF, HDD Power/Access, Fan, Temperature
- **Switch:** Power ON/OFF Momentary (Pushbutton), System Reset, Buzzer Reset
- **Dimensions (W x H x D):** 483 x 88 x 650mm (19" x 3.5" x 25.6")
- **Cuft:** 4.4
- **GW:** 17.2 kgs / 37.9 lbs
- **Carton Size(cm):** 58.8 x 25.5 x 82.5 (23.1" x 10" x 32.5")
- **Humidity:** 5% - 95% Non-condensing

Dimension

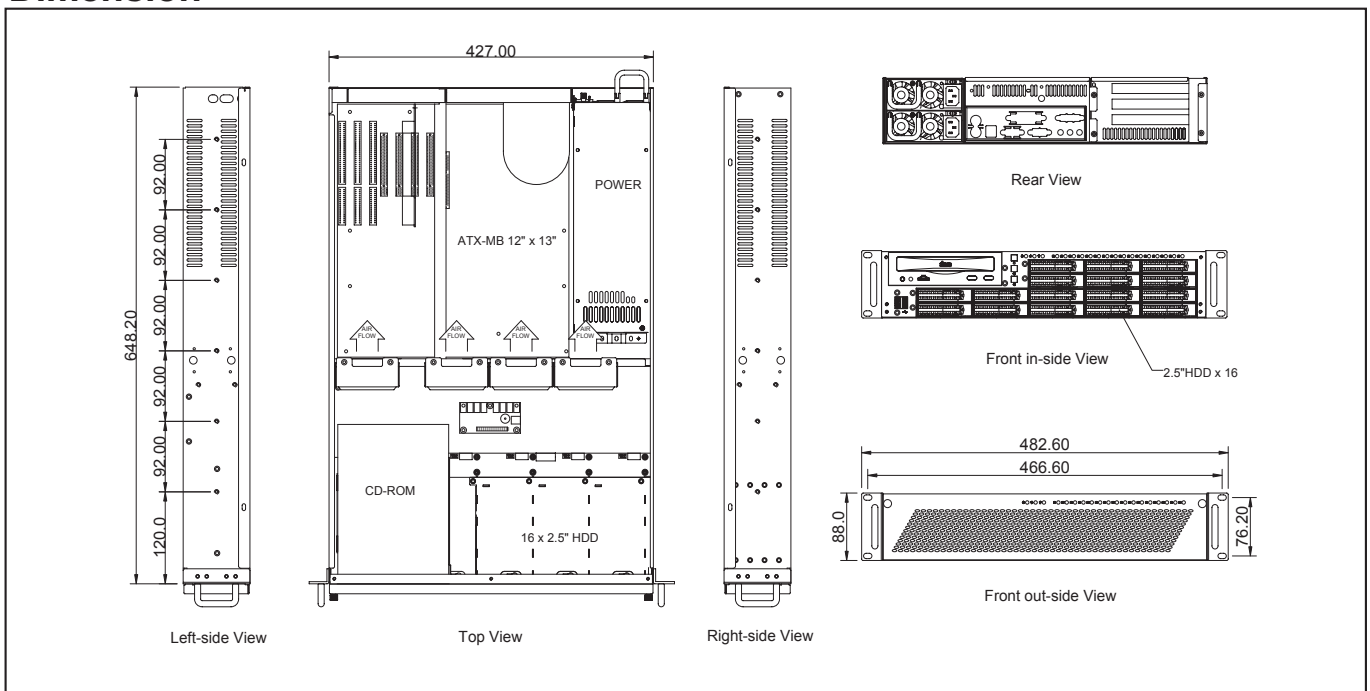

GHI-270

2U Rackmount Chassis

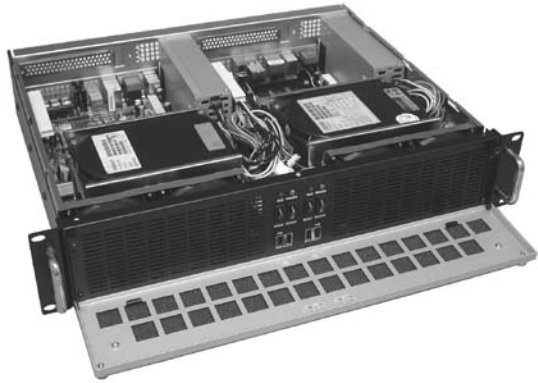

Specifications

- **Mounting:** Rack Mount or Wall Mount or Desktop
- **Construction:** Heavy Duty Cold Rolled Electroplated Steel
- **Color:** Black (Standard), Beige or Custom
- **Support Dual Mini-ITX M/B (Max. to 6.7" x 6.7")**
- **Drive Capacity :** 4x 3.5" HDD
- **Power Supply(Optional):** Dual 1U 150~300W ATX P/S (Rear Installation) W=80mm, D=150mm
- **Cooling:** 4x (80mm = 42.5CFM ea.) Fans
- **Expansion Slots:** 2 PCI Slot
- **Riser Card:** 2 - 1x GHP-PCI106H (Optional)
- **Connector Port (Front):** 4x USB Ports
- **Indicators:** LEDs for Power ON/OFF, HDD Activity
- **Switch:** Power ON/OFF, System Reset
- **Dimensions (W x H x D):** 483x88x356mm (19"x 3.5" x 14")
- **Cuft:** 2.0
- **GW:** 8.7 kgs / 19.2 lbs
- **Carton Size(cm):** 57 x 20.3 x 50 (22.4" x 8" x 19.7")
- **Humidity:** 5% - 95% Non-condensing

Dimension

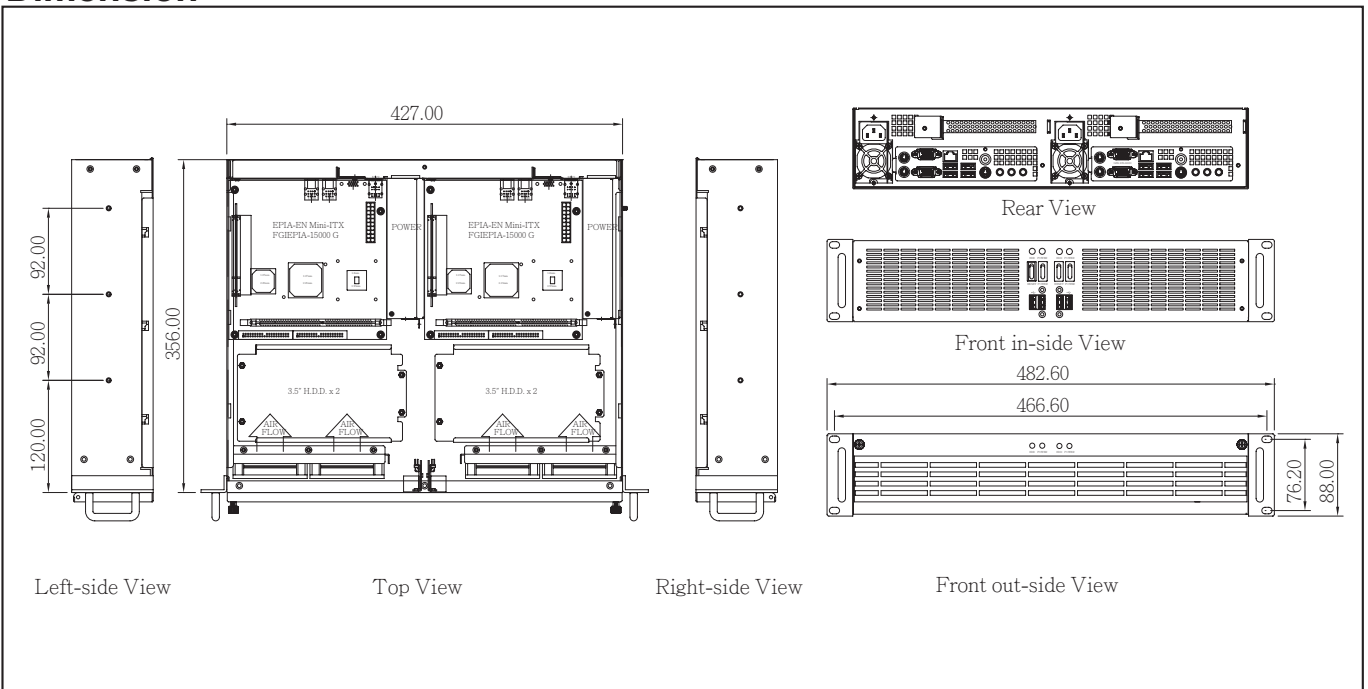

GHI-280/280V

2U Rackmount Chassis



19" Rackmount

Specifications

- **EIA RS-310C 19" Rackmount Standard**
- **Construction:** Heavy Duty Cold Rolled Electroplated Steel
- **Color:** Black (Standard), Beige or Custom
- **System Boards:** Pentium 4, Dual Xeon, Athlon 64, Dual Opteron
- **Support EATX M/B (Max. to 12" x 13") SSI EEB 3.0**
- **Drive Capacity:** 1x Slim CD-ROM & 1x Slim FDD & 8x 3.5" Swappable Trays & 2x 2.5"HDD & 1x 3.5"HDD (Optional)
- **Drive Interface:** PATA, SATA, SCSI320, Multilane SATA or SAS
- **Power Supply (Optional):** 2U Single up to 600W or 2U Redundant up to 500W ATX P/S(Rear Installation) Max. Depth 300mm
- **Cooling:** 4x (80mm = 42.5CFM ea.) Fans
- **Front Door:** Single Door with 2 Thumbscrews (Removable)

- **Riser Card:** Please Check Page 194-196 For Optional 2U Riser Card
- **Connector Port (Front):** 2x USB Ports
- **Expansion Slots(Optional):** 2 or 3x Horizontal ISA/PCI/AGP Option Slots(GHI-280) 7x Low Profile PCI Slots(GHI-280V)
- **Thermal Management Card:** GHA-CO04
- **Indicators:** LEDs for Power ON/OFF, HDD Activity, Fan, Temperature, LAN
- **Switch:** Power ON/OFF Momentary (Pushbutton), System Reset, Buzzer Reset
- **Dimensions (WxHxD):** 483 x 88 x 650mm (19" x 3.5" x 25.6")
- **Cuft:** 4.4
- **GW:** 18.5 kgs / 40.8 lbs
- **Carton Size(cm):** 58.8 x 25.5 x 82.5 (23.1" x 10" x 32.5")
- **Humidity:** 5% - 95% Non-condensing

Dimension

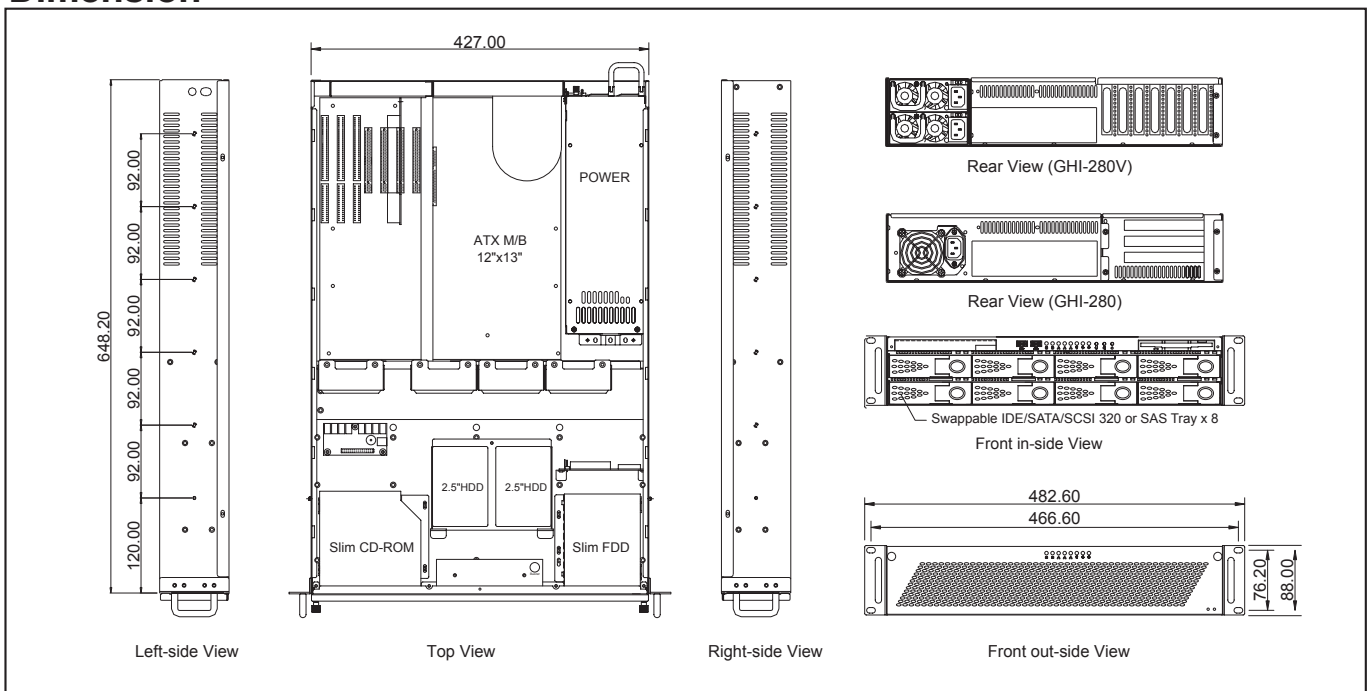

GHI-281/281V

2U Rackmount Chassis



Specifications

- **EIA RS-310C 19" Rackmount Standard**
- **Construction:** Heavy Duty Cold Rolled Electroplated Steel
- **Color:** Black (Standard), Beige or Custom
- **System Boards:** Pentium 4, Dual Xeon, Athlon 64, Dual Opteron
- **Support EATX M/B (Max. to 12" x 13") SSI EEB 3.0**
- **Drive Capacity:** 1x 5.25" & 1x Slim FDD & 6x 3.5" Swappable Trays & 1x 2.5"HDD
- **Drive Interface:** PATA, SATA, SCSI320 or SAS
- **Power Supply (Optional):** 2U Single up to 600W or 2U Redundant up to 500W ATX P/S(Rear Installation) Max. Depth 300mm
- **Cooling:** 4x (80mm = 42.5CFM ea.) Fans
- **Front Door:** Single Door with 2 Thumbscrews (Removable)
- **Riser Card:** Please Check Page 194-196 For Optional 2U Riser Card
- **Connector Port (Front):** 2x USB Ports
- **Expansion Slots(Optional):** 2 or 3x Horizontal ISA/PCI/AGP Option Slots(GHI-281)
7x Low Profile PCI Slots(GHI-281V)
- **Thermal Management Card:** GHA-CO04
- **Indicators:** LEDs for Power ON/OFF , HDD Activity, Fan, Temperature, LAN
- **Switch:** Power ON/OFF Momentary (Pushbutton), System Reset, Buzzer Reset
- **Dimensions (WxHxD):** 483 x 88 x 650mm (19" x 3.5" x 25.6")
- **Cuft:** 4.4
- **GW:** 18.5kgs / 40.8lbs
- **Carton Size(cm):** 58.8 x 25.5 x 82.5 (23.1" x 10" x 32.5")
- **Humidity:** 5% - 95% Non-condensing

Dimension

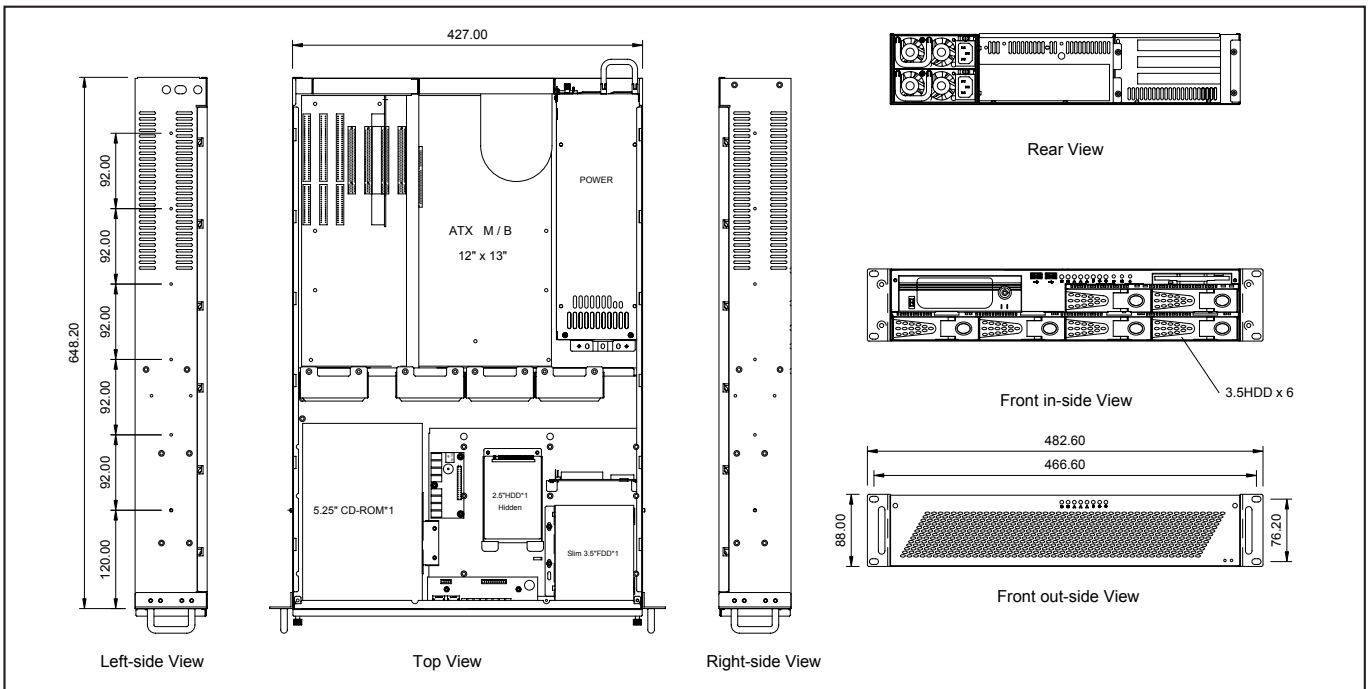

GHI-282/282V

2U Rackmount Chassis

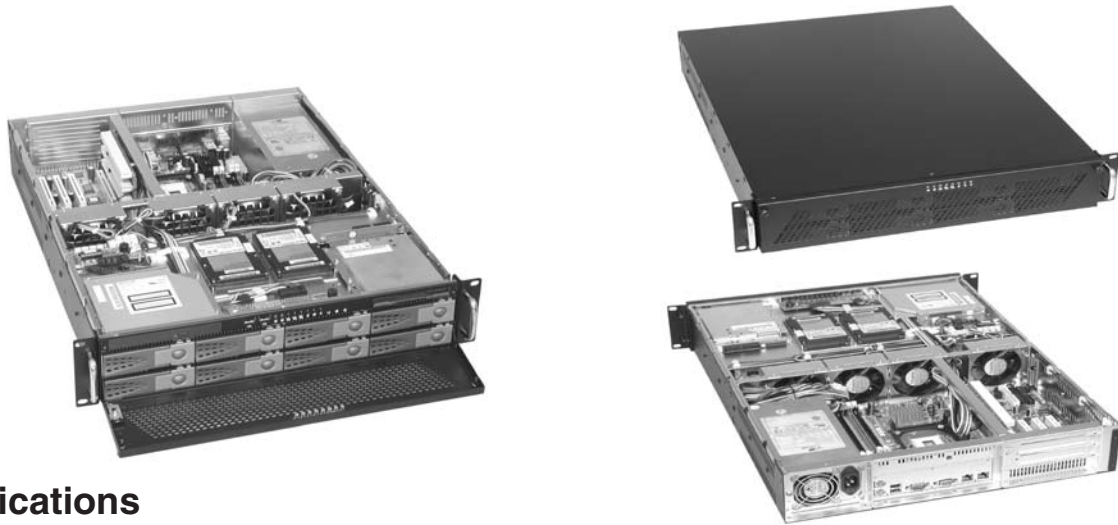

Specifications

- **EIA RS-310C 19" Rackmount Standard**
- **Construction:** Heavy Duty Cold Rolled Electroplated Steel
- **Color:** Black (Standard), Beige or Custom
- **System Boards:** Pentium 4, Dual Xeon, Athlon 64
- **Support ATX M/B (Max. to 12" x 9.6")**
- **Drive Capacity:** 1x Slim CD-ROM & 1x Slim FDD & 8x 3.5" Swappable Trays & 2x 2.5"HDD
- **Drive Interface:** PATA, SATA, SCSI320, Multilane SATA or SAS
- **Power Supply (Optional):** 2U Single up to 510W or Redundant up to 400W ATX P/S (Rear Installation) Max. Depth 240mm
- **Cooling:** 4x (80mm = 42.5CFM ea.) Fan
- **Front Door:** Single Door with 2 Thumbscrews(Removable)
- **Riser Card:** Please Check Page 194-196 For Optional 2U Riser Card
- **Connector Port (Front):** 2x USB Ports
- **Expansion Slots (Optional):** 2 or 3x Horizontal ISA/PCI/AGP Option Slots(GHI-282), 7x Low Profile PCI Slots(GHI-282V)
- **Thermal Management Card:** GHA-CO04
- **Indicators:** LEDs for Power ON/OFF, HDD Activity, Fan, Temperature, LAN
- **Switch:** Power ON/OFF Momentary (Pushbutton), System Reset, Buzzer Reset
- **Dimensions (WxHxD):** 483 x 88 x 565mm (19" x 3.5" x 22.2")
- **Cuft:** 3.9
- **GW:** 17.5kgs / 38.5lbs
- **Carton Size(cm):** 58.8 x 25.5 x 74.5 (23.1" x 10" x 29.3")
- **Humidity:** 5% - 95% Non-condensing

Dimension

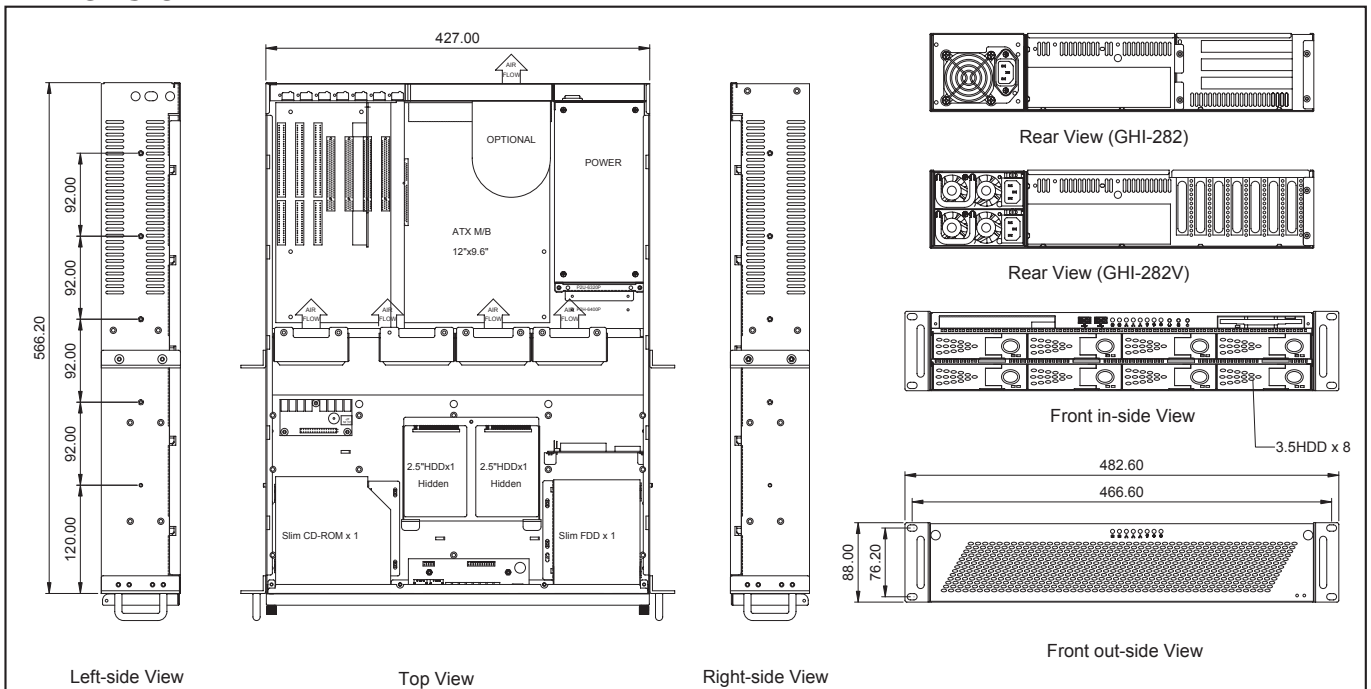

GHI-283/283V

2U Rackmount Chassis



Specifications

- **EIA RS-310C 19" Rackmount Standard**
- **Construction:** Heavy Duty Cold Rolled Electroplated Steel
- **Color:** Black (Standard), Beige or Custom
- **System Boards:** Dual Xeon, Pentium 4, Athlon 64, Dual Opteron
- **Support EATX M/B (Max. to 12" x 13") SSI EEB 3.0**
- **Drive Capacity:** 2x 5.25" & 1x 3.5"HDD & 4x 3.5" Swappable Trays
- **Drive Interface:** PATA, SATA, SCSI320, Multilane SATA or SAS
- **Power Supply (Optional):** 2U Single up to 600W or 2U Redundant up to 500W ATX P/S(Rear Installation) Max. Depth 300mm
- **Cooling:** 4x (80mm = 42.5CFM ea.)Fans
- **Front Door:** Single Door with 2 Thumbscrews (Removable)
- **Riser Card:** Please Check Page 194-196 For Optional 2U Riser Card
- **Connector Port (Front):** 2x USB Ports
- **Expansion Slots(Optional):** 2 or 3x Horizontal ISA/PCI/AGP Option Slots(GHI-283)
7x Low Profile PCI Slots(GHI-283V)
- **Indicators:** LEDs for Power ON/OFF, HDD Activity, LAN
- **Switch:** Power ON/OFF Momentary (Pushbutton), System Reset
- **Dimensions (WxHxD):** 483 x 88 x 650mm (19" x 3.5" x 25.6")
- **Cuft:** 4.4
- **GW:** 18.5kgs / 40.8lbs
- **Carton Size(cm):** 58.8 x 25.5 x 82.5 (23.1" x 10" x 32.5")
- **Humidity:** 5% - 95% Non-condensing

Dimension

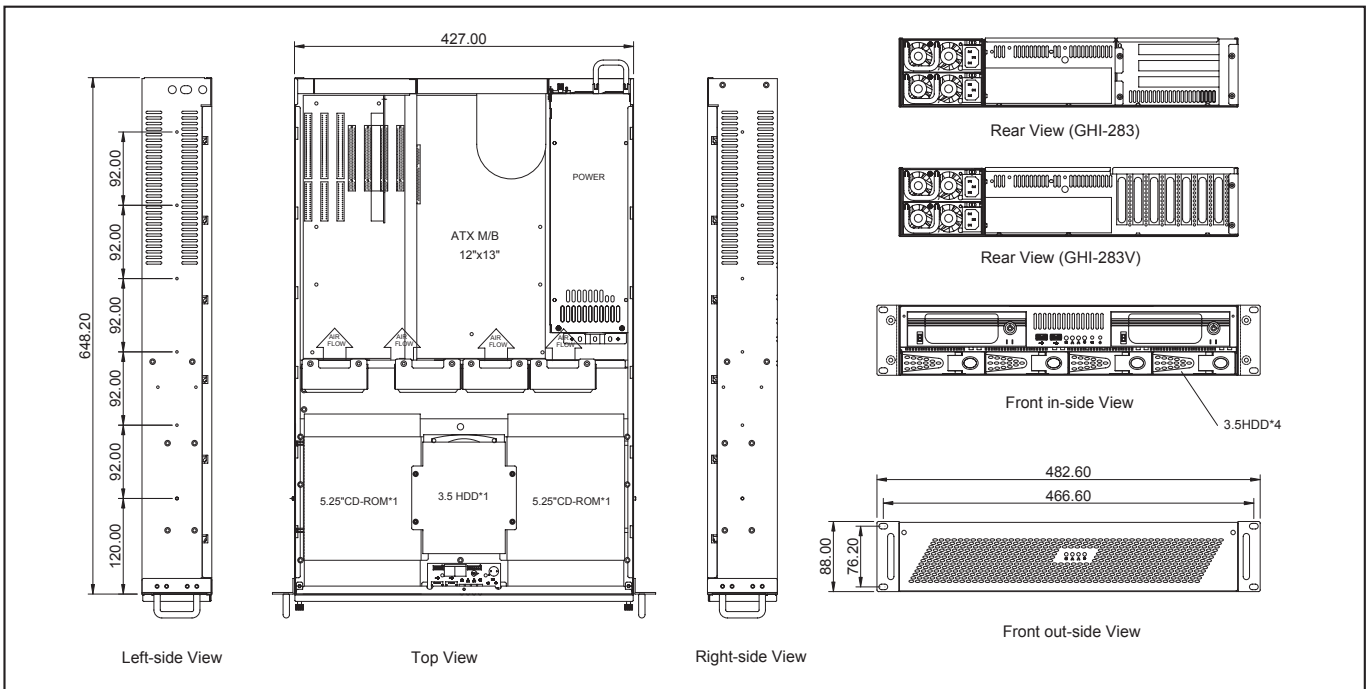

GH-288SR

2U Rackmount Chassis



Specifications

- **EIA RS-310C 19" Rackmount Standard**
- **Construction:** Heavy Duty Cold Rolled Electroplated Steel
- **Color:** Black (Standard), Beige or Custom
- **Support 6-slot Passive Backplane**
- **Drive Capacity:** 1x 5.25" & 1x 3.5" & 2x 3.5" HDD
- **Power Supply (Optional):** PS/2 size Single up to 700W or Mini Redundant up to 500W P/S (Rear Installation)
- **Cooling:** 2x (80mm = 42.5CFM ea.) Fans
- **Front Door:** Drive panel door with Keylock
- **Air Filter:** Inside Front Panel (Washable)
- **Connector Port (Front):** 1x PS/2 Port
- **Indicators:** LEDs for Power ON/OFF, HDD Activity
- **Switch:** Power ON/OFF Momentary (Rocker), System Reset
- **Dimensions (WxHxD):** 483 x 88 x 526mm (19" x 3.5" x 20.7")
- **Cuft:** 3.6
- **GW:** 15.0kgs / 33.1lbs
- **Carton Size(cm):** 58.8 x 25.5 x 68.5 (23.1" x 10" x 27")
- **Humidity:** 5% - 95% Non-condensing

Dimension

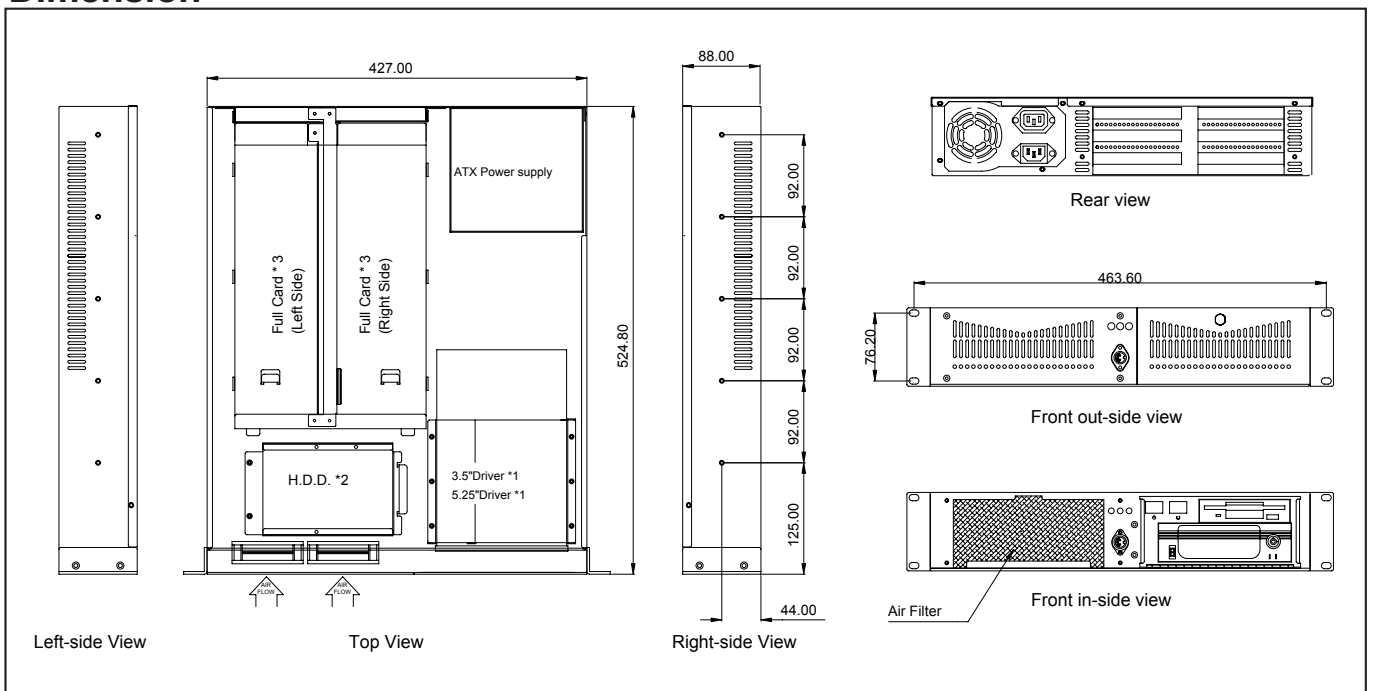

GHI-289

2U Rackmount Chassis

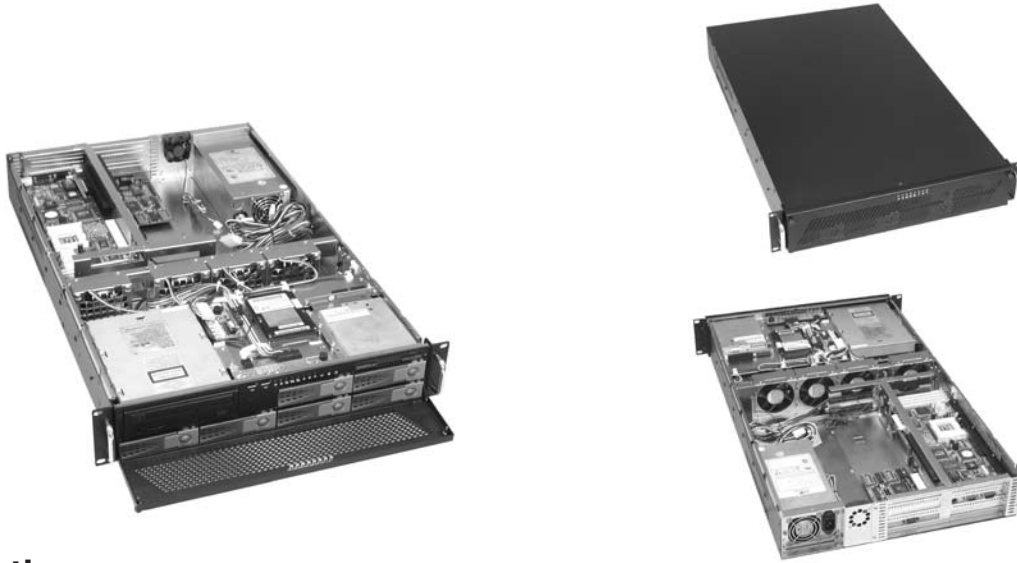

Specifications

- **EIA RS-310C 19" Rackmount Standard**
- **Construction:** Heavy Duty Cold Rolled Electroplated Steel
- **Color:** Black (Standard), Beige or Custom
- **Supports 6 Slot Passive Backplane**
- **Drive Capacity:** 1x 5.25", 1x Slim FDD, 6x 3.5" Hot Swappable Drive Tray & 1x 2.5" HDD
- **Drive Interface:** PATA, SATA, SCSI320 or SAS
- **Power Supply (Optional):** 2U Single up to 600W or 2U Redundant up to 500W ATX P/S ea. (Rear Installation) Max. Depth 300mm
- **Cooling:** 4x (80mm = 42.5CFM ea.) Fans & 1x (40mm = 15.3CFM ea.) Fans
- **Front Door:** Single Door with 2 Thumbscrews (Removable)
- **Connector Port (Front):** 2x USB Ports
- **Thermal Management Card:** GHA-CO04
- **Indicators:** LEDs for Power ON/OFF, 2x HDD, Fan, & 3x LAN Activity
- **Switch:** Power ON/OFF Momentary(Rocker), System Reset
- **Dimensions (WxHxD):** 483 x 88x 696mm (19" x 3.5" x 25.6")
- **Cuft:** 4.6
- **GW:** 18.5kgs / 40.8lbs
- **Carton Size (cm):** 86.1 x 25.5 x 59.5 (33.9" x 10" x 23.4")
- **Humidity:** 5% - 95% Non-condensing

Dimension

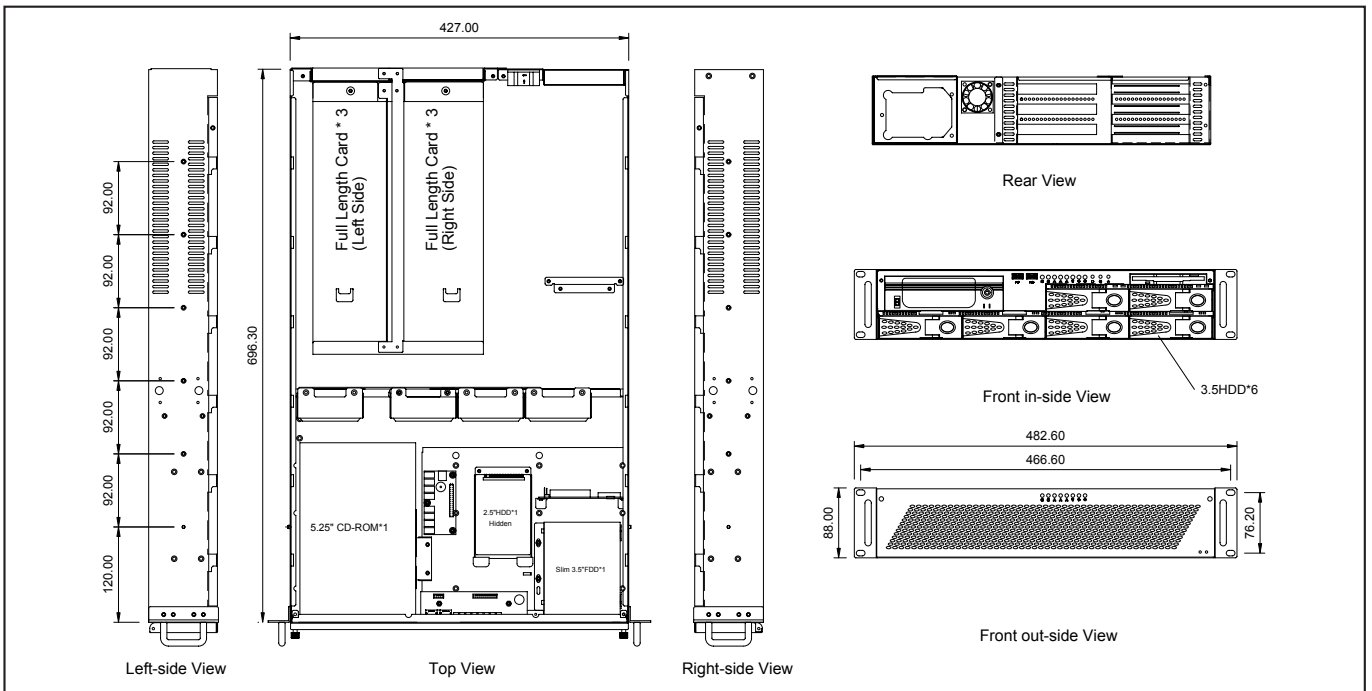

GHI-290/290V

2U Rackmount Chassis

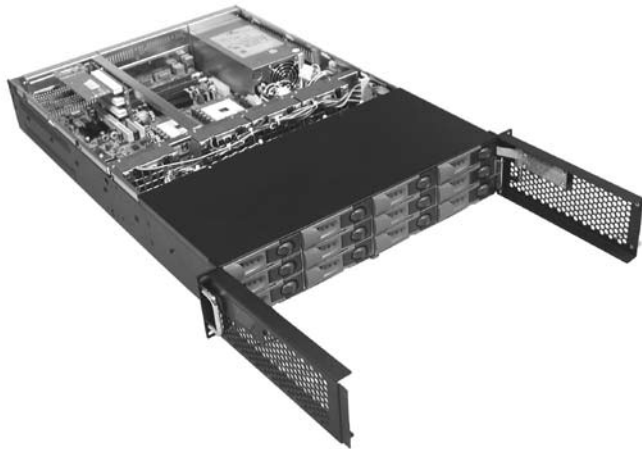

19" Rackmount

Specifications

- **EIA RS-310C 19" Rackmount Standard**
- **Construction:** Heavy Duty Cold Rolled Electroplated Steel
- **Color:** Black (Standard), Beige or Custom
- **System Boards:** Pentium 4, Dual Xeon, Athlon 64, Dual Opteron
- **Support EATX M/B (Max. to 12" x 13") SSI EEB 3.0**
- **Drive Capacity:** 12 x 3.5" Swappable Trays
- **Drive Interface:** SATA, SCSI320, Multilane SATA or SAS
- **Power Supply (Optional):** 2U Single up to 600W or 2U Redundant up to 500W ATX P/S(Rear Installation) Max. Depth 300mm
- **Cooling:** 4x (80mm = 42.5CFM ea.) Fans
- **Front Door:** Two Horizontal Doors with 2 Thumbscrews
- **Riser Card:** Please Check Page 194-196 For Optional 2U Riser Card
- **Expansion Slots(Optional):** 2 or 3x Horizontal ISA/PCI/AGP Option Slots(GHI-290) or 7x Low Profile PCI Slots(GHI-290V)
- **Thermal Management Card:** GHA-CO08
- **Indicators:** LEDs for Power ON/OFF, HDD Activity, Fan, Temperature, LAN
- **Switch:** Power ON/OFF Momentary (Pushbutton), System Reset, Buzzer Reset
- **Dimensions (WxHxD):** 483 x88 x 650mm (19" x 3.5" x 25.6")
- **Cuft:** 4.4
- **GW:** 16.8 kgs / 37 lbs
- **Carton Size(cm):** 58.8 x 25.5 x 82.5 (23.1" x 10" x 32.5")
- **Humidity:** 5% - 95% Non-condensing

Dimension

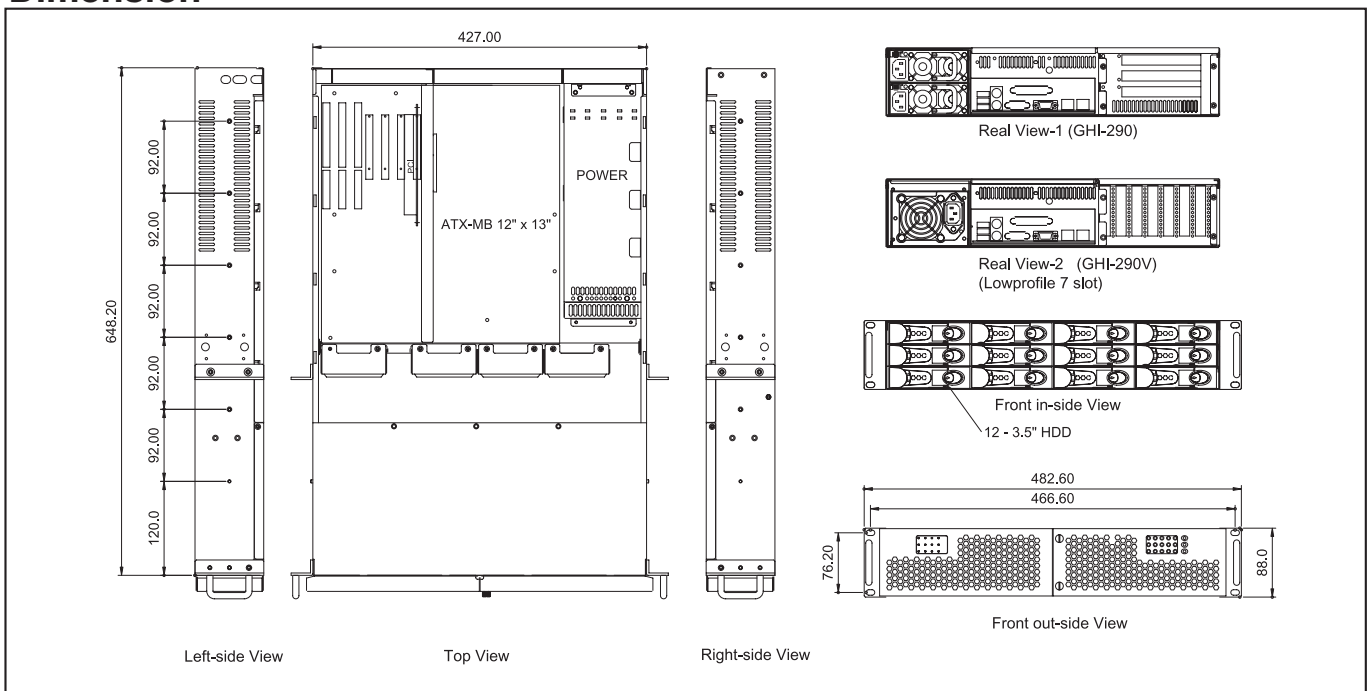

GHI-293/293V

2U Rackmount Chassis



Specifications

- **EIA RS-310C 19" Rackmount Standard**
- **Construction:** Heavy Duty Cold Rolled Electroplated Steel
- **Color:** Black (Standard), Beige or Custom
- **System Boards:** Dual Xeon, Pentium 4, Athlon 64, Dual Opteron
- **Support EATX M/B (Max. to 12" x 10.5") SSI EEB 3.0**
- **Drive Capacity:** 2x 5.25" & 1x 3.5"FDD & 4x 3.5" Swappable Trays
- **Drive Interface:** SATA, SCSI320, Multilane SATA or SAS
- **Power Supply (Optional):** 2U Single up to 600W or 2U Redundant up to 500W ATX P/S(Rear Installation) Max. Depth 300mm
- **Cooling:** 3x (80mm = 42.5CFM ea.)Fans
- **Front Door:** Single Door With 2 Thumbscrews (Removable)
- **Riser Card:** Please Check Page 194-196 For Optional 2U Riser Card
- **Connector Port (Front):** 2x USB Ports
- **Expansion Slots(Optional):** 2 or 3x Horizontal ISA/PCI/AGP Option Slots(GHI-293) or 7x Low Profile PCI Slots(GHI-293V)
- **Indicators:** LEDs for Power ON/OFF, 4xHDD Activity, Fan, Temperature, LAN
- **Switch:** Power ON/OFF Momentary (Pushbutton), System Reset, Buzzer Reset
- **Dimensions (W x H x D):** 483 x 88 x 560mm (19" x 3.5" x 22.1")
- **Cuft:** 3.3
- **GW:** 13.9kgs / 30.7lbs
- **Carton Size(cm):** 57 x 22 x 73.5 (22.4" x 8.7" x 28.9")
- **Humidity:** 5% - 95% Non-condensing

Dimension

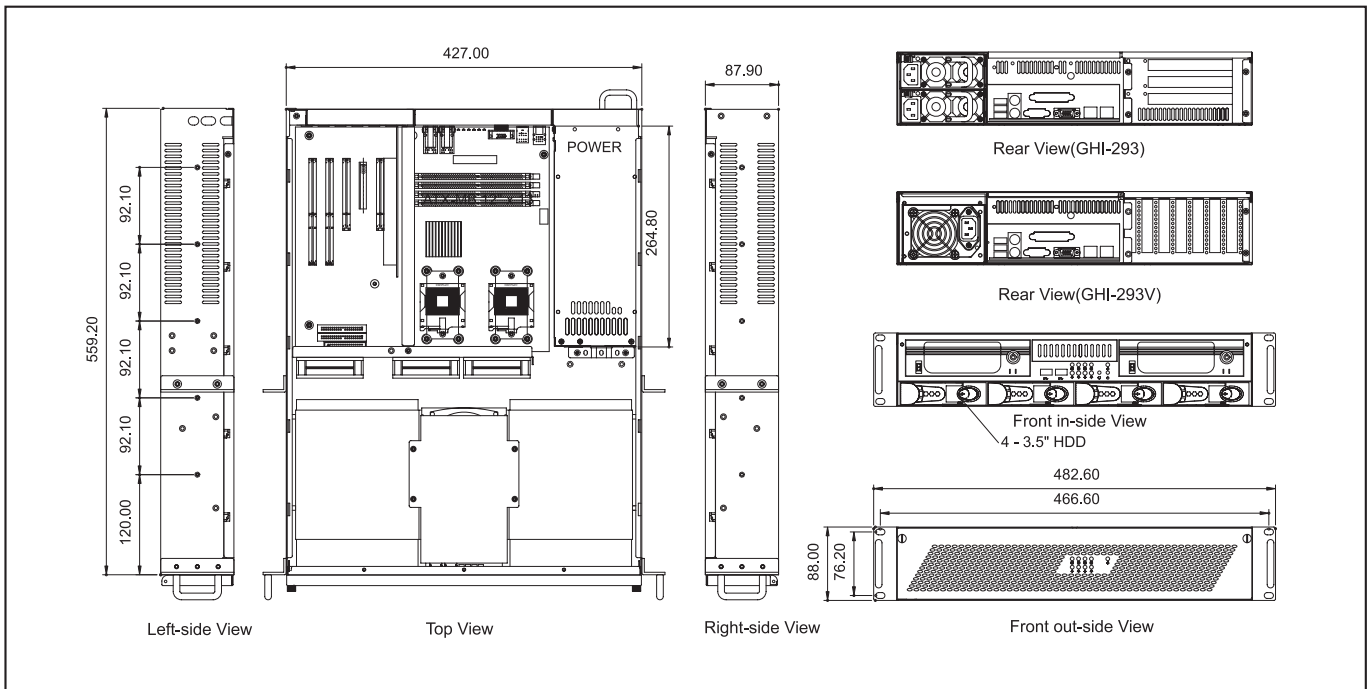

GHI-XP2

2U Rackmount Fanless Chassis



19" Rackmount

Specifications

- EIA RS-310C 19" Rackmount Standard
- Construction: Aluminum
- Color: Silver or Custom
- System Boards: Dual Xeon, Pentium 4, Dual Pentium III
- Support ATX M/B(Max. to 9.6" x 9.6")
- Drive Capacity: 1x 5.25" CD-ROM & 2x 2.5"HDD
- Power Supply(Optional): Flex ATX 240W P/S Max. Depth 175mm
- Cooling: Heat sink With Heat Pipe for CPU and VGA Card Chip
- Connector Port (Front): 2x USB Ports
- Expansion Slots(Optional): 2 or 3x Horizontal Slots(ISA, PCI, AGP Option) or 7x Low Profile PCI Slots
- Indicators: LEDs for Power ON/OFF, HDD Activity
- Switch: Power ON/OFF, System Reset
- Dimensions (W x H x D): 420 x 89 x 385mm (16.5"x3.5"x15.2")
- Cufft: 3.3
- GW: 14.3 kgs / 31.5 lbs
- Carton Size(cm): 57 x 22 x 73.5 (22.4" x 8.7" x 28.9")
- Humidity: 5% - 95% Non-condensing

Dimension

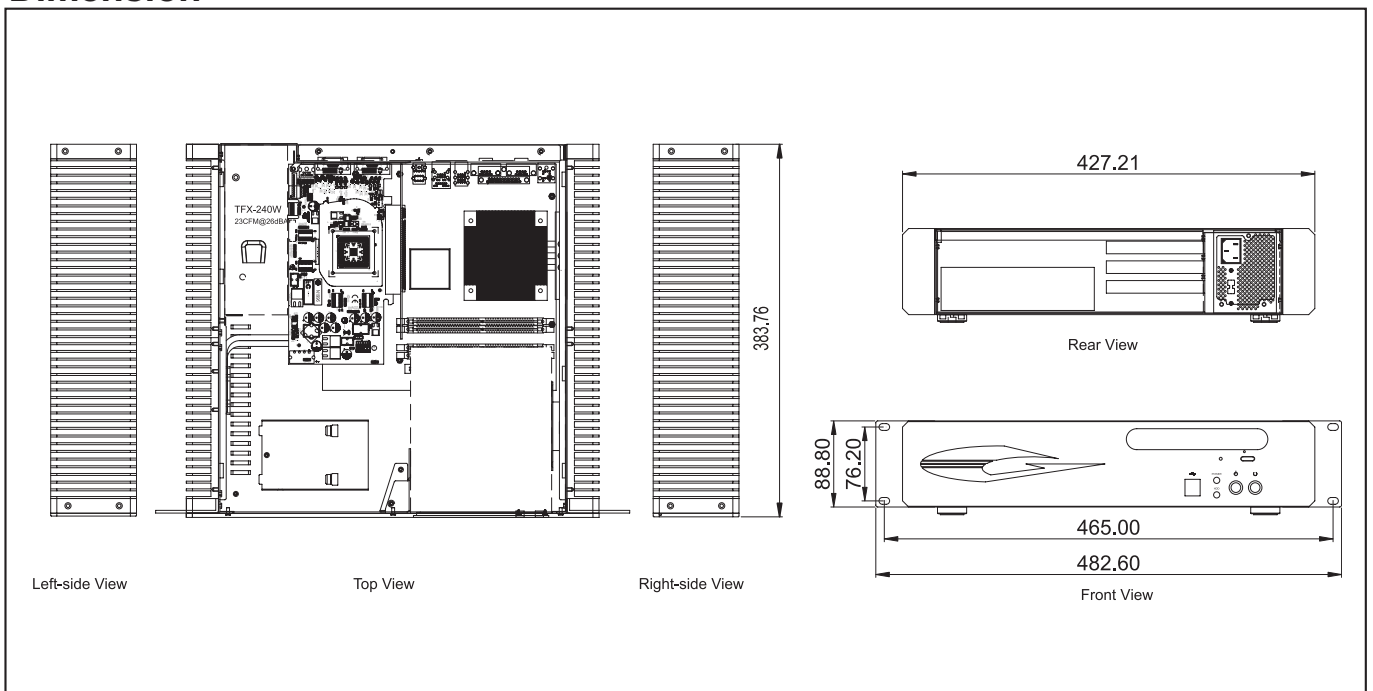

GH-310ATXR

3U Rackmount Chassis



Specifications

- **EIA RS-310C 19" Rackmount Standard**
- **Construction:** Heavy Duty Cold Rolled Electroplated Steel
- **Color:** Black (Standard), Beige or Custom
- **System Boards:** Dual Xeon, Pentium 4, Athlon 64, Dual Opteron, Pentium 4
- **Support ATX M/B (Max. to 12" x 9.6")**
- **Drive Capacity:** 2x 5.25" & 1x 3.5" & 5x 3.5" HDD
- **Power Supply (Optional):** PS/2 size single up to 700W or Mini Redundant up to 500W ATX P/S (Front/Mid Installation) Max. Depth 185mm
- **Cooling:** 1x (80mm = 42.5CFM ea.) & 2x (92mm = 51CFM ea.) Fans
- **Connector Port (Front):** 2x USB Ports (Optional)
- **Front Door:** Single Door with 1 Thumb Twist Keylock
- **Air Filter:** Inside Front Door (Washable)
- **Expansion Slots:** 7 slot
- **Indicators:** LEDs for Power ON/OFF, HDD Activity
- **Switch:** Power ON/OFF Momentary (Rocker), System Reset
- **Dimensions (WxHxD):** 483 x 133 x 526mm (19" x 5.2" x 20.7")
- **Cuft:** 4.2
- **GW:** 16.0 kgs / 35.3 lbs
- **Carton Size(cm):** 58.8 x 28.5 x 70.3 (23.1" x 11.2" x 27.7")
- **Humidity:** 5% - 95% Non-condensing

Dimension

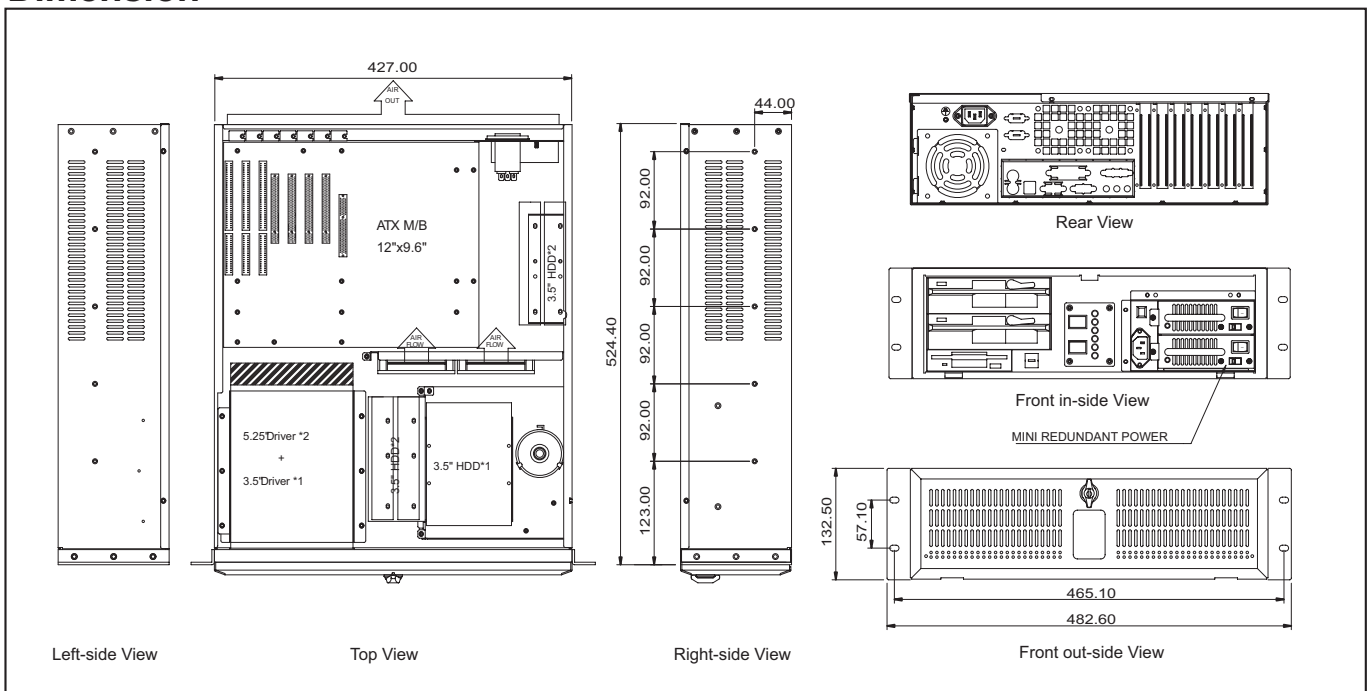

GHI-312

3U Rackmount Chassis



Specifications

- **EIA RS-310C 19" Rackmount Standard**
- **Construction:** Heavy Duty Cold Rolled Electroplated Steel
- **Color:** Black (Standard), Beige or Custom
- **System Boards:** Dual Xeon, Pentium 4, Athlon 64, Dual Opteron
- **Support EATX M/B (Max. to 12" x 13") SSI EEB 3.0**
- **Drive Capacity:** 2x 5.25" & 1x 3.5" & 7x 3.5" HDD & 2x 3.5" HDD (Optional)
- **Power Supply (Optional):** 2U Single up to 700W or 2U Redundant up to 500W ATX P/S (Rear Installation) Max. Depth 300mm
- **Cooling:** 5x (92mm = 51CFM ea.) & 1x (60mm = 23.5CFM ea.) Fans
- **Front Door:** Single Door with 1 Thumb Twist Keylock
- **Air Filter:** Inside Front Door (Washable)
- **Connector Port (Front):** 2x USB Ports
- **Expansion Slots:** 7 slot
- **Indicators:** LEDs for Power ON/OFF, HDD Activity
- **Switch:** Power ON/OFF Momentary(Rocker), System Reset
- **Dimensions (WxHxD):** 483 x 133 x 650mm (19.0" x 5.2" x 25.6")
- **Cuft:** 5.3
- **GW:** 17.2 kgs / 37.9 lbs
- **Carton Size(cm):** 81.8 x 59.4 x 31 (32.2" x 23.4" x 12.2")
- **Humidity:** 5% - 95% Non-condensing

Dimension

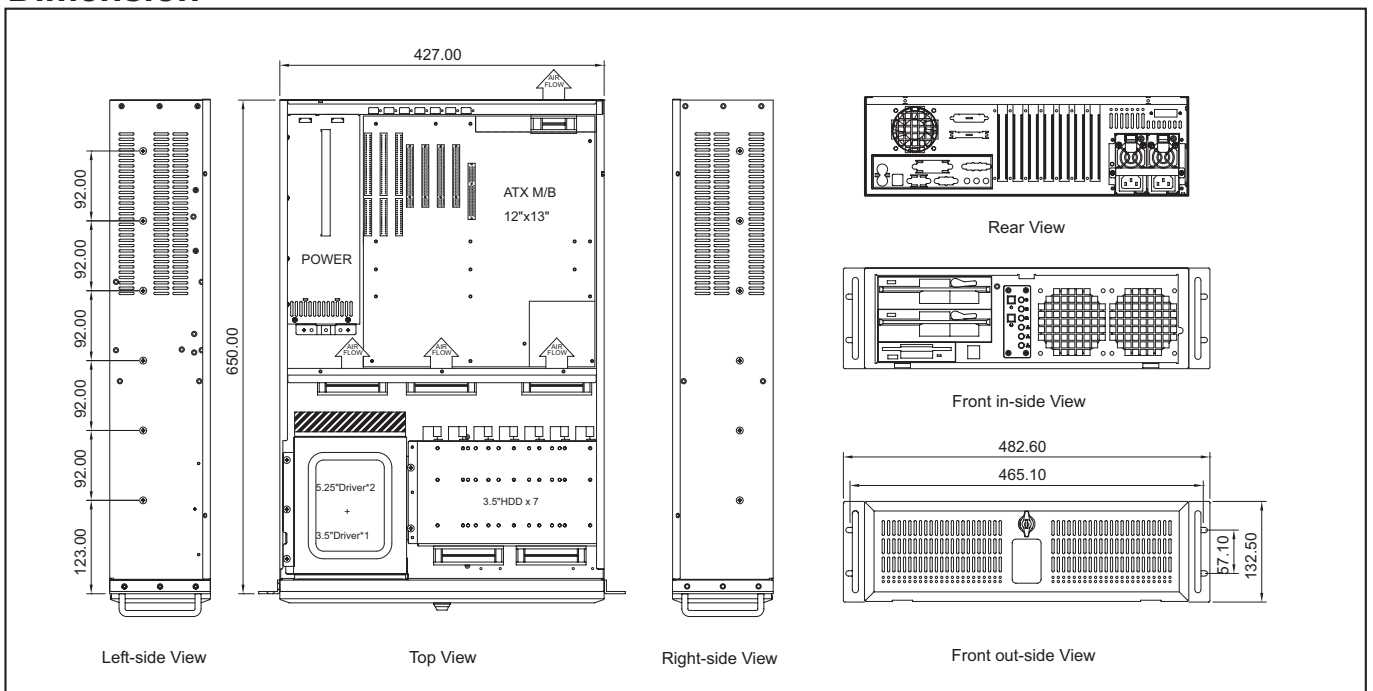

GHI-313

3U Rackmount Chassis



Specifications

- **EIA RS-310C 19" Rackmount Standard**
- **Construction:** Heavy Duty Cold Rolled Electroplated Steel
- **Color:** Black (Standard), Beige or Custom
- **System Boards:** Pentium 4, Dual Xeon, Athlon 64
- **Supports ATX M/B (Max. to 12" x 10.5")**
- **Drive Capacity:** 2x 5.25", 1x 3.5" FDD & 7x 3.5" HDD & 1x 3.5" HDD (Optional)
- **Power Supply (Optional):** 2U Single up to 600W or 2U Redundant up to 500W ATX P/S (Rear Installation) Max. Depth 250mm
- **Cooling:** 2x (92mm = 51CFM ea.) Fans & 2x (60mm = 23.5CFM ea.) Fan
- **Front Door:** Single Door with 1 Thumb Twist Keylock
- **Air Filter:** Inside Front Door (Washable)
- **Connector Port (Front):** 2x USB Ports
- **Indicators:** LEDs for Power ON/OFF, 2x HDD, Fan, & 3x LAN Activity
- **Switch:** Power ON/OFF Momentary (Rocker), System Reset
- **Dimensions (WxHxD):** 483 x 133 x 526mm (19" x 5.2" x 20.7")
- **Cuft:** 4.2
- **GW:** 14.6 kgs / 32.2 lbs
- **Carton Size (cm):** 58.8 x 28.5 x 70.3 (23.1" x 11.2" x 27.7")
- **Humidity:** 5% - 95% Non-condensing

Dimension

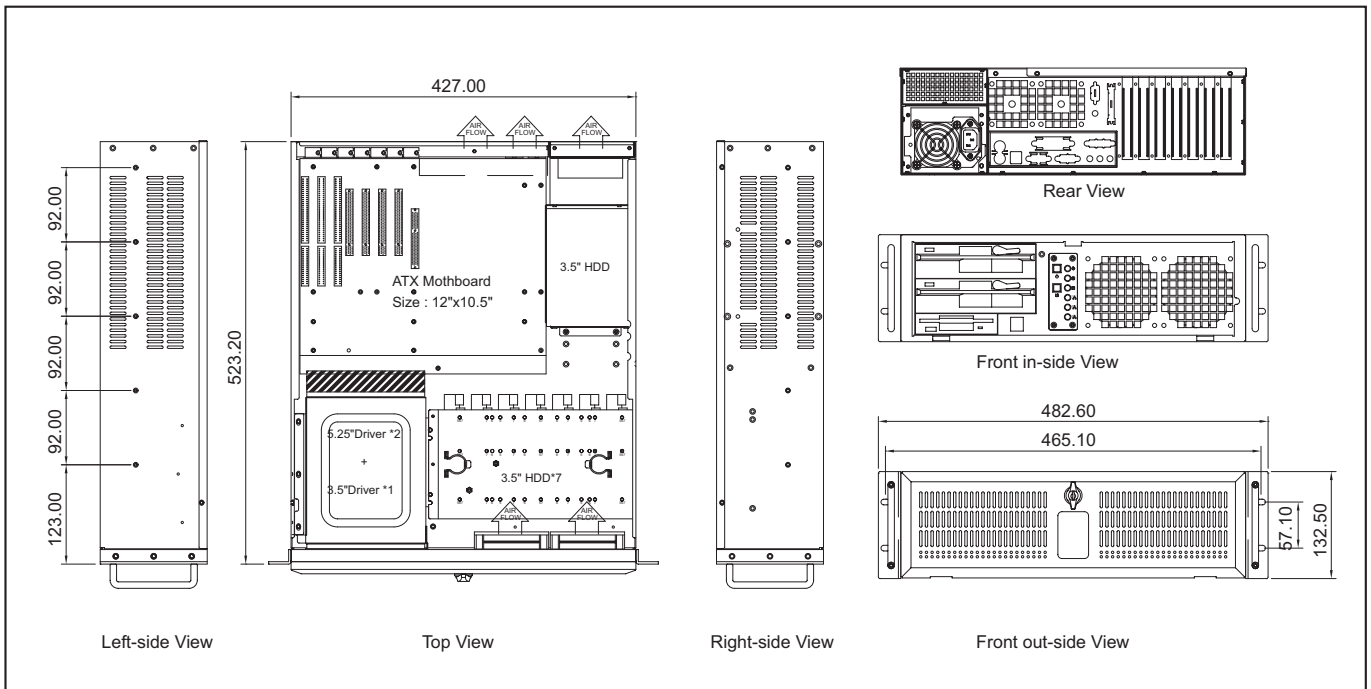

GHI-314

3U Rackmount Chassis

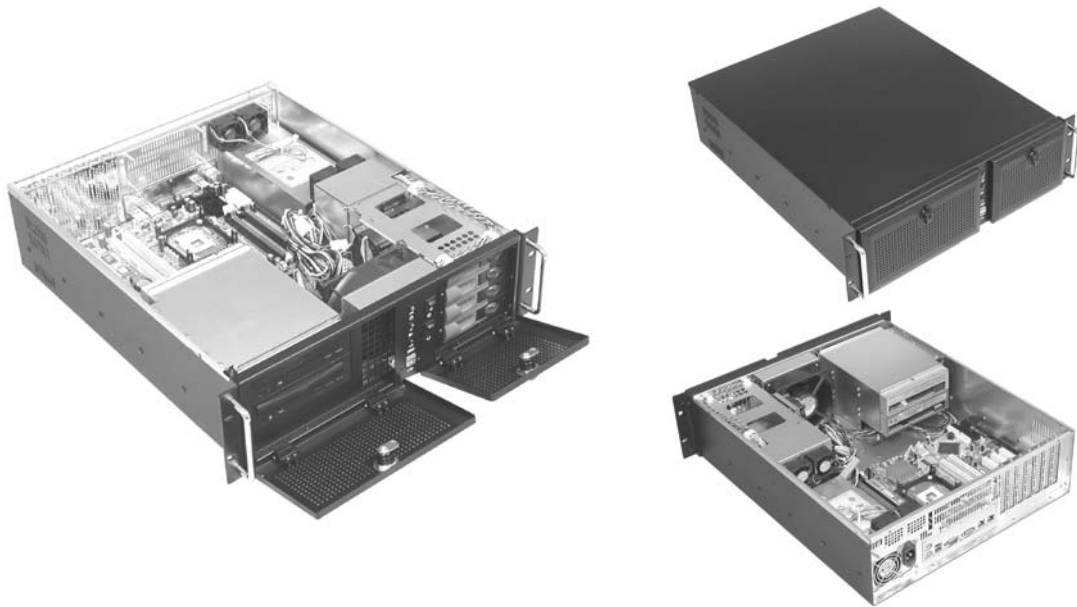

Specifications

- **EIA RS-310C 19" Rackmount Standard**
- **Construction:** Heavy Duty Cold Rolled Electroplated Steel
- **Color:** Black (Standard), Beige or Custom
- **System Boards:** Pentium 4, Dual Xeon, Athlon 64
- **Supports ATX M/B (Max. to 12" x 10.5")**
- **Drive Capacity:** 2x 5.25" , 4x 3.5" Swappable Trays
- **Drive Interface:** SCSI320, SATA or SAS
- **Power Supply (Optional):** 2U Single up to 510W or 2U Redundant up to 400W ATX P/S (Rear Installation) Max. Depth 250mm
- **Cooling:** 1x (120mm = 108CFM ea.) & 2x (60mm = 23.5CFM ea.) & 4x (40mm = 15.3CFM ea.) Fans
- **Connector Port (Front):** 2x USB Ports
- **Indicators:** LEDs for Power ON/OFF, HDD Activity, LAN
- **Switch:** Power ON/OFF Momentary (Rocker), System Reset
- **Dimensions (W x H x D):** 483 x 133 x 524mm (19" x 5.2" x 20.6")
- **Cuft:** 4.2
- **GW:** 15.5 kgs / 34.2 lbs
- **Carton Size (cm):** 58.8 x 28.5 x 70.3 (23.1" x 11.2" x 27.7")
- **Humidity:** 5% - 95% Non-condensing

Dimension

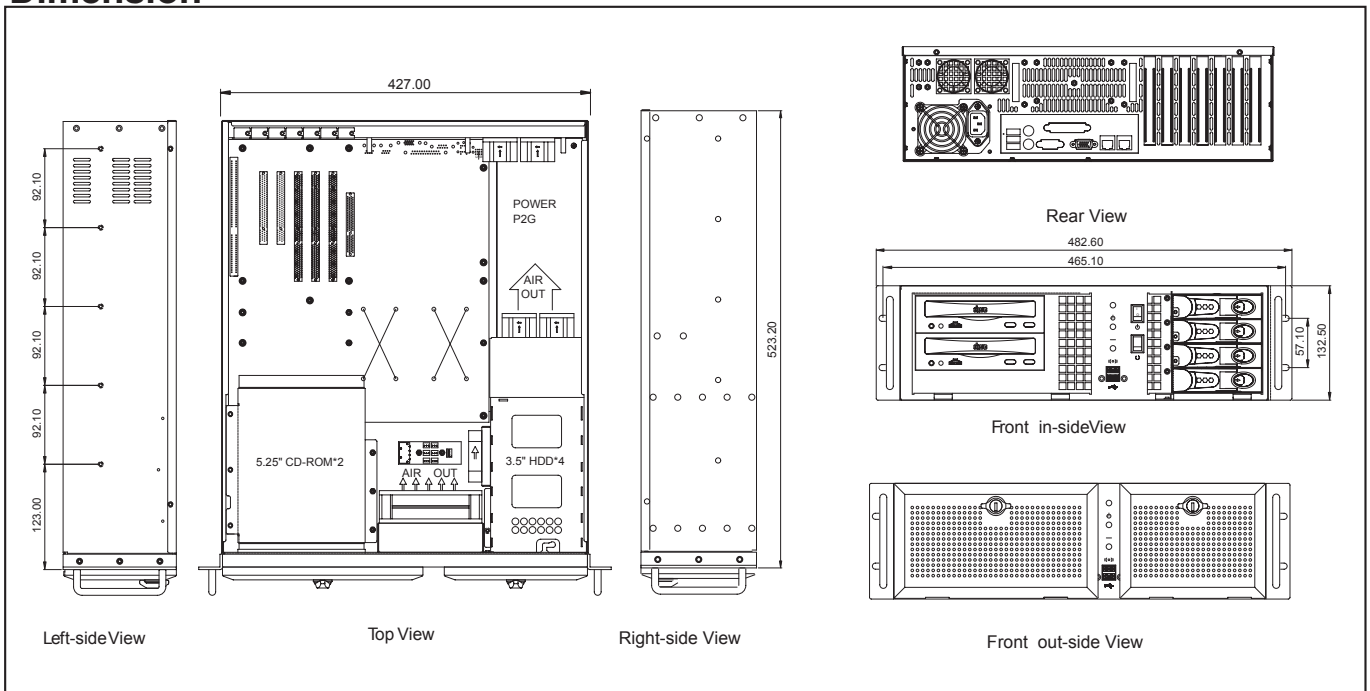

GHI-315

3U Rackmount Chassis



Specifications

- **EIA RS-310C 19" Rackmount Standard**
- **Construction:** Heavy Duty Cold Rolled Electroplated Steel
- **Color:** Black (Standard), Beige or Custom
- **System Boards:** Pentium 4, Dual Xeon, Athlon 64, Dual Opteron
- **Support ATX M/B (Max. to 12" x 9.6") SSI EEB 3.0**
- **Drive Fnterface:** SCSI 320 , SATA or SAS
- **Drive Capacity:** 1x 5.25" Slim CD-ROM & 3x 3.5" Hot Swappable Trays
- **Power Supply(Optional):** 2U Single up to 600W or 2U Redundant up to 500W ATX PSU Max. Depth 300mm
- **Expansion Slots:** 7 slot Full Length
- **Front Door:** Two Doors With Thumb Twist Keylock
- **Cooling:** 2x (60mm = 23.5CFM ea.) Fans & 2x (40mm = 7CFM ea.)
- **Connector Port (Front):** 2 X USB Ports
- **LCD:** 6.4" 640x480 Digital TFT Panel With Touch Screen
- **Indicators:** LEDs for Power ON/OFF, HDD, LAN Activity
- **Switch:** Power ON/OFF Momentary (Rocker), System Reset and Panel ON/OFF
- **Dimensions (W x H x D):** 483 x 133 x 526mm (19" x 5.2" x 20.7")
- **Cuft:** 4.2
- **GW:** 14.8 kgs / 32.6 lbs
- **Carton Size(cm):** 58.8 x 28.5 x 70.3(23.2" x 11.2" x 27.7")
- **Humidity:** 5% - 95% Non-condensing

Dimension

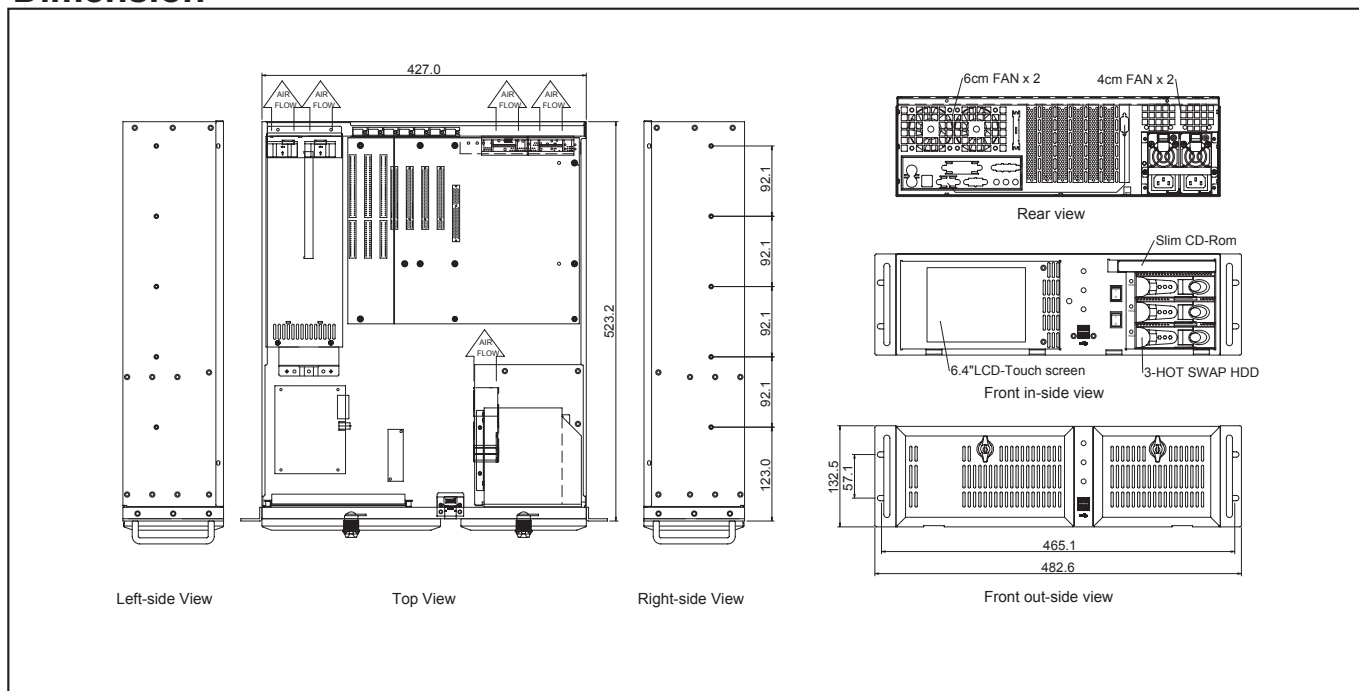

GH-342ATX

3U Rackmount Chassis



19" Rackmount

Specifications

- **EIA RS-310C 19" Rackmount Standard**
- **Construction:** Heavy Duty Cold Rolled Electroplated Steel
- **Color:** Black (Standard), Beige or Custom
- **System Boards:** Pentium 4, Dual Xeon, Athlon 64, Dual Opteron
- **Support EATX M/B (Max. to 12" x 13") SSI EEB 3.0**
- **Drive Interface:** P-ATA, SATA, SCSI320 or SAS
- **Drive Capacity:** 2x 5.25" & 1x 3.5" & 6x 3.5" Hot Swappable Trays
- **Power Supply (Optional):** 2U Single up to 650W or 2U Redundant up to 500W ATX P/S (Rear Installation) Max. Depth 300mm
- **Cooling:** 3x (92mm = 51CFM ea.) & 1x (60mm = 23.5CFM ea.) Fans
- **Front Door:** Single Door With 1 Thumb Twist Keylock
- **Air Filter:** Inside Front Door (Washable)
- **Expansion Slots:** 7 slot Full Length
- **Thermal Management Card:** GHA-CO04
- **Indicators:** LEDs for Power ON/OFF, HDD Activity, Fan, Temperature
- **Switch:** Power ON/OFF Momentary (Rocker), System Reset
- **Dimensions (W x H x D):** 483 x 133 x 650mm (19" x 5.2" x 25.6")
- **Cuft:** 5.3
- **GW:** 13.0kgs / 39.7lbs
- **Carton Size(cm):** 59.4 x 31 x 81.8 (23.4" x 12.2" x 32.2")
- **Humidity:** 5% - 95% Non-condensing

Dimension

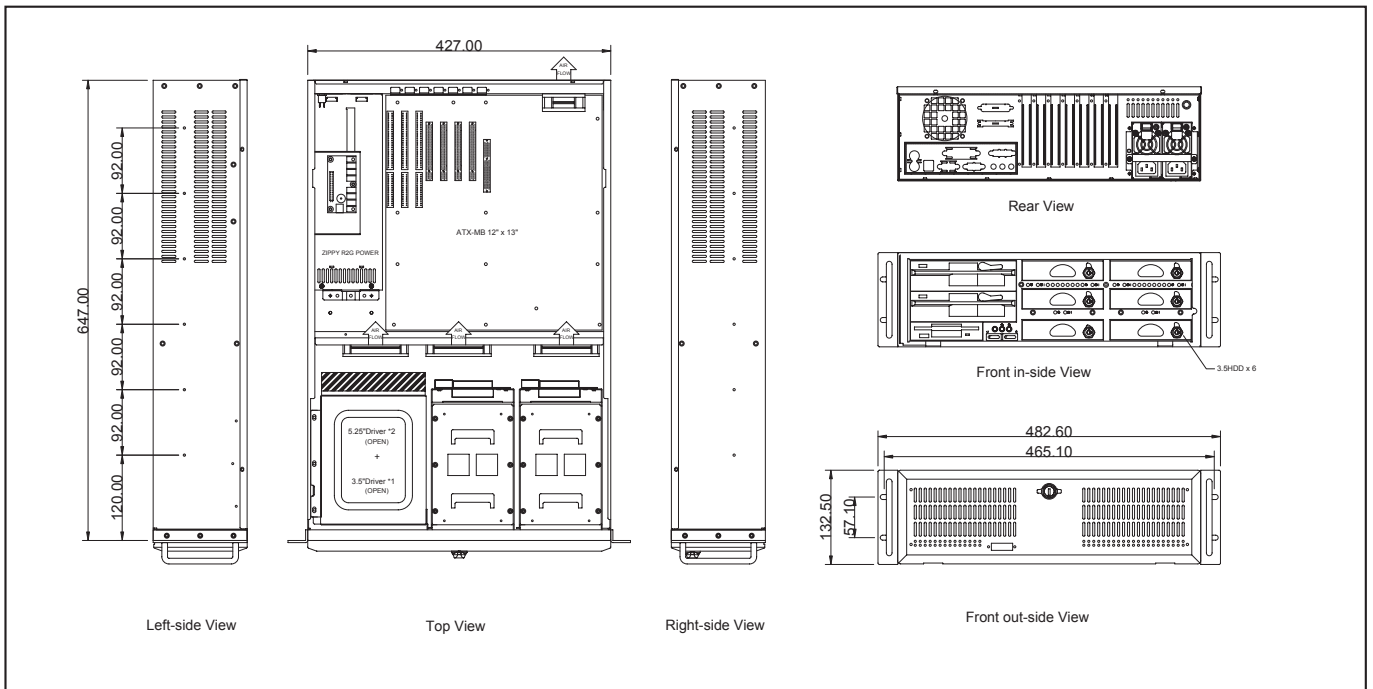

GHI-346

3U Rackmount Chassis



Specifications

- **EIA RS-310C 19" Rackmount Standard**
- **Construction:** Heavy Duty Cold Rolled Electroplated Steel
- **Color:** Black (Standard), Beige or Custom
- **System Boards:** Pentium 4, Dual Xeon, Athlon 64, Dual Opteron
- **Support EATX M/B (Max. to 12" x 13") SSI EEB 3.0**
- **Drive Capacity:** 6x 5.25" & 1x 3.5"FDD & 2x 3.5"HDD
- **Power Supply (Optional):** 2U Single up to 650W or 2U Redundant up to 500W or 3U Single up to 950W ATX P/S or 3U Redundant up to 650W ATX P/S (Rear Installation) Max. Depth 300mm
- **Cooling:** 4x (92mm = 51CFM ea.) & 2x (60mm = 23.5CFM ea.) Fans
- **Front Door:** Single Door With 2 Thumbscrews (Removable)
- **Connector Port (Front):** 2x USB Ports
- **Expansion Slots:** 7 slot Full Length
- **Indicators:** LEDs for Power ON/OFF, HDD Activity , LAN
- **Switch:** Power ON/OFF, System Reset
- **Dimensions (W x H x D):** 483 x 133 x 650mm (19" x 5.2" x 25.6")
- **Cuft:** 5.3
- **GW:** 16.7 kgs / 36.8 lbs
- **Carton Size(cm):** 59.4 x 31 x 81.8 (23.4" x 12.2" x 32.2")
- **Humidity:** 5% - 95% Non-condensing

Dimension

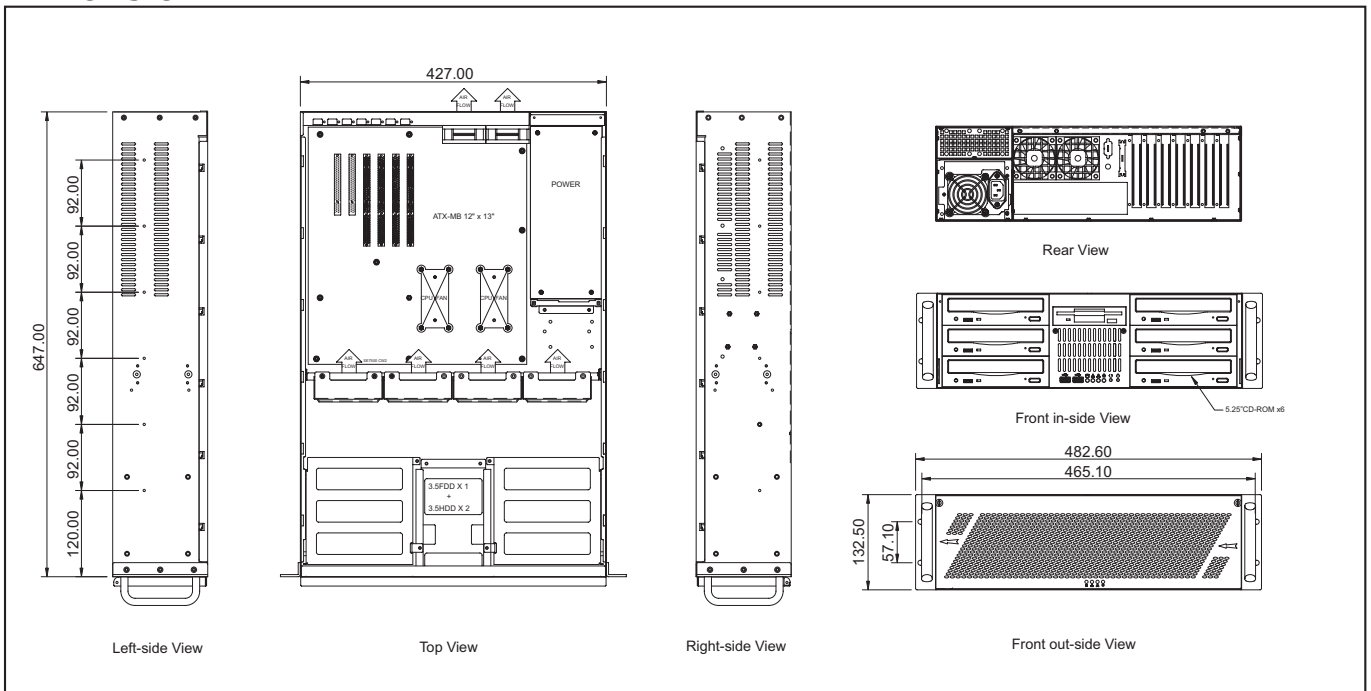

GHI-347

3U Rackmount Chassis



19" Rackmount

Specifications

- **EIA RS-310C 19" Rackmount Standard**
- **Construction:** Heavy Duty Cold Rolled Electroplated Steel
- **Color:** Black (Standard), Beige or Custom
- **System Boards:** Pentium 4, Dual Xeon, Athlon 64, Dual Opteron
- **Support EATX M/B (Max. to 12" x 10.5") SSI EEB 3.0**
- **Drive Capacity:** 6x 5.25"CD-ROM & 1x 3.5"HDD
- **Power Supply (Optional):** 2U Single or 3U Redundant up to 700W Max. Depth 300mm
- **Cooling:** 4x (92mm = 51CFM ea.) & 2x (60mm = 23.5CFM ea.) (Optional) Fans
- **Front Door:** Two Doors With 1 Keylock
- **Connector Port (Front):** 2x USB
- **Indicators:** LEDs for Power ON/OFF, HDD Activity, LAN
- **Switch:** Power ON/OFF , System Reset
- **Dimensions (W x H x D):** 483 x 133 x 560mm (19" x 5.2" x 22.1")
- **Cuft:** 3.4
- **GW:** 14.4 kgs / 31.8 lbs
- **Carton Size (cm):** 70 x 24.2 x 56 (27.6" x 9.5" x 22.1")
- **Humidity:** 5% - 95% Non-condensing

Dimension

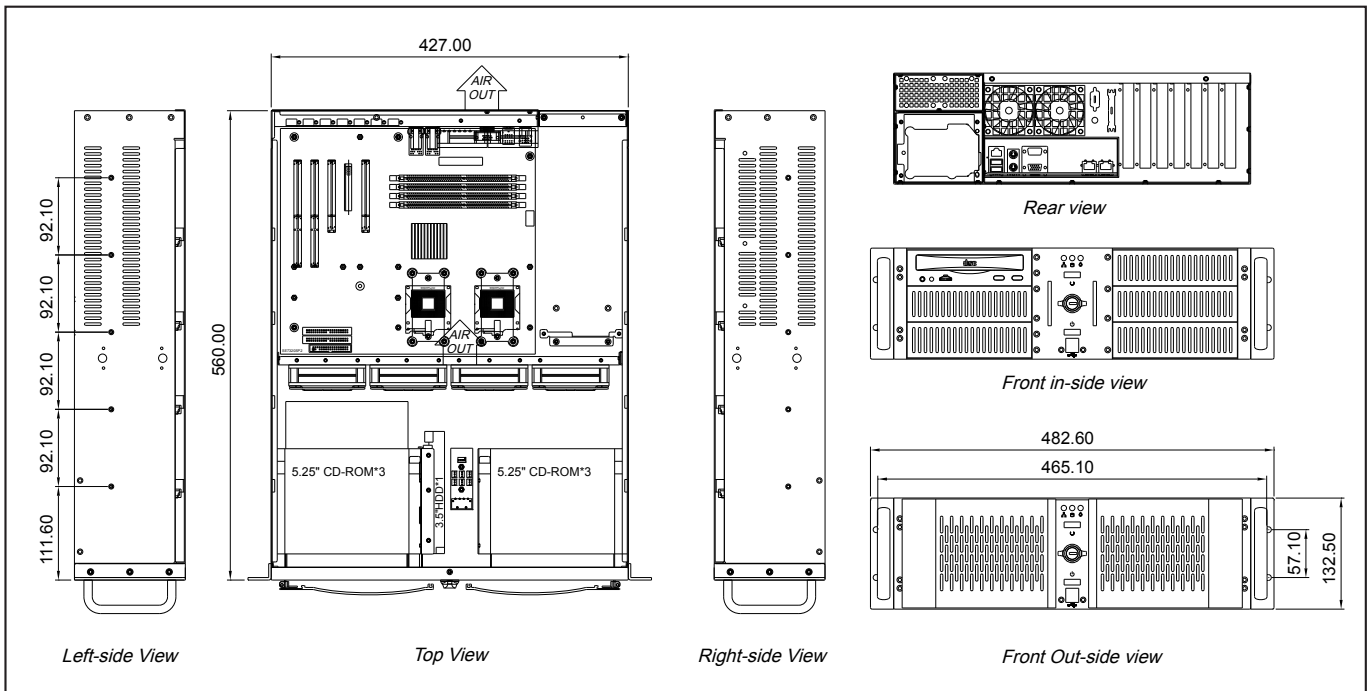

GHI-350

3U Rackmount Chassis



Specifications

- **EIA RS-310C 19" Rackmount Standard**
- **Construction:** Heavy Duty Cold Rolled Electroplated Steel
- **Color:** Black (Standard), Beige or Custom
- **System Boards:** Pentium 4, Dual Xeon, Athlon 64
- **Support ATX M/B (Max. to 12" x 9.6")**
- **Drive Capacity:** 1x 5.25" & 2x 3.5" HDD
- **Power Supply(Optional):** 2U Single up to 460W ATX P/S Max. Depth 270mm
- **Cooling:** 2x (80mm = 42.5CFM ea.) & 2x (40mm = 7CFM ea.) Fans & 1x (60mm 23.5CFM ea.) Fan (Optional)
- **Expansion Slots:** 7 slot
- **Indicators:** LEDs for Power ON/OFF, HDD Activity, LAN
- **Switch:** Power ON/OFF, System Reset on Rear Side
- **Dimensions (WxHxD):** 483 x 133 x 400mm (19" x 5.2" x 15.7")
- **Cuft:** 3.5
- **GW:** 11.2 kgs / 24.7 lbs
- **Carton Size(cm):** 58 x 28.5 x 59.9 (22.8" x 11.2" x 23.6")
- **Humidity:** 5% - 95% Non-condensing

Dimension

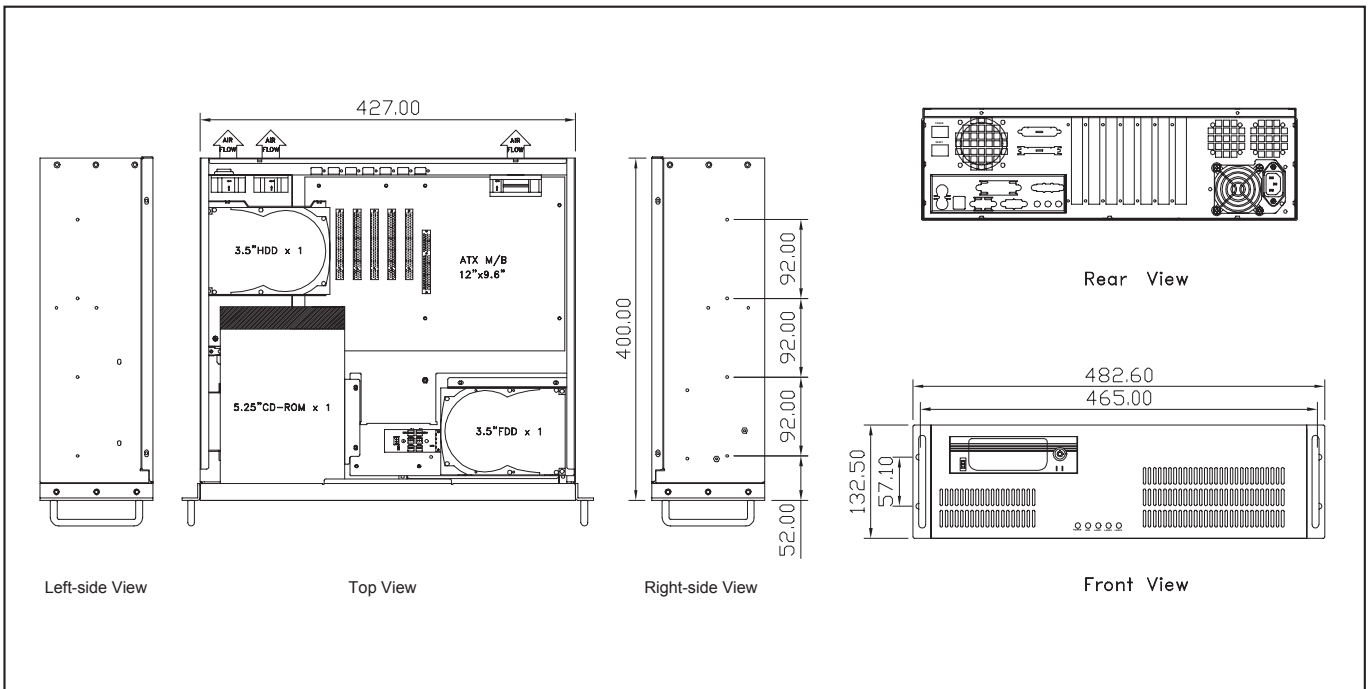

GHI-351

3U Rackmount Chassis



Specifications

- **EIA RS-310C 19" Rackmount Standard**
- **Construction:** Heavy Duty Cold Rolled Electroplated Steel
- **Color:** Black (Standard), Beige or Custom
- **System Boards:** Pentium 4, Dual Xeon, Athlon 64, Dual Opteron
- **Support ATX M/B (Max. to 12" x 9.6")**
- **Drive Capacity:** 1x 5.25" & 1x 3.5" FDD & 2x 3.5" HDD
- **Power Supply (Optional):** 2U Single up to 650W or 2U Redundant up to 500W ATX P/S (Rear Installation) Max. Depth 300mm
- **Cooling:** 2x (80mm = 42.5CFM ea.) & 2x (60mm = 23.5CFM ea.) (Optional) Fans
- **Connector Port (Front):** 2 X USB Ports
- **Expansion Slots:** 7 slot Full Length
- **Indicators:** LEDs for Power ON/OFF, HDD Activity , LAN
- **Switch:** Power ON/OFF Momentary (Rocker), System Reset
- **Dimensions (W x H x D):** 483 x 133 x 400mm (19" x 5.2" x 15.8")
- **Cuft:** 3.5
- **GW:** 11.7 kgs / 25.8 lbs
- **Carton Size(cm):** 58 x 28.5 x 59.9 (22.8" x 11.2" x 23.6")
- **Humidity:** 5% - 95% Non-condensing

Dimension

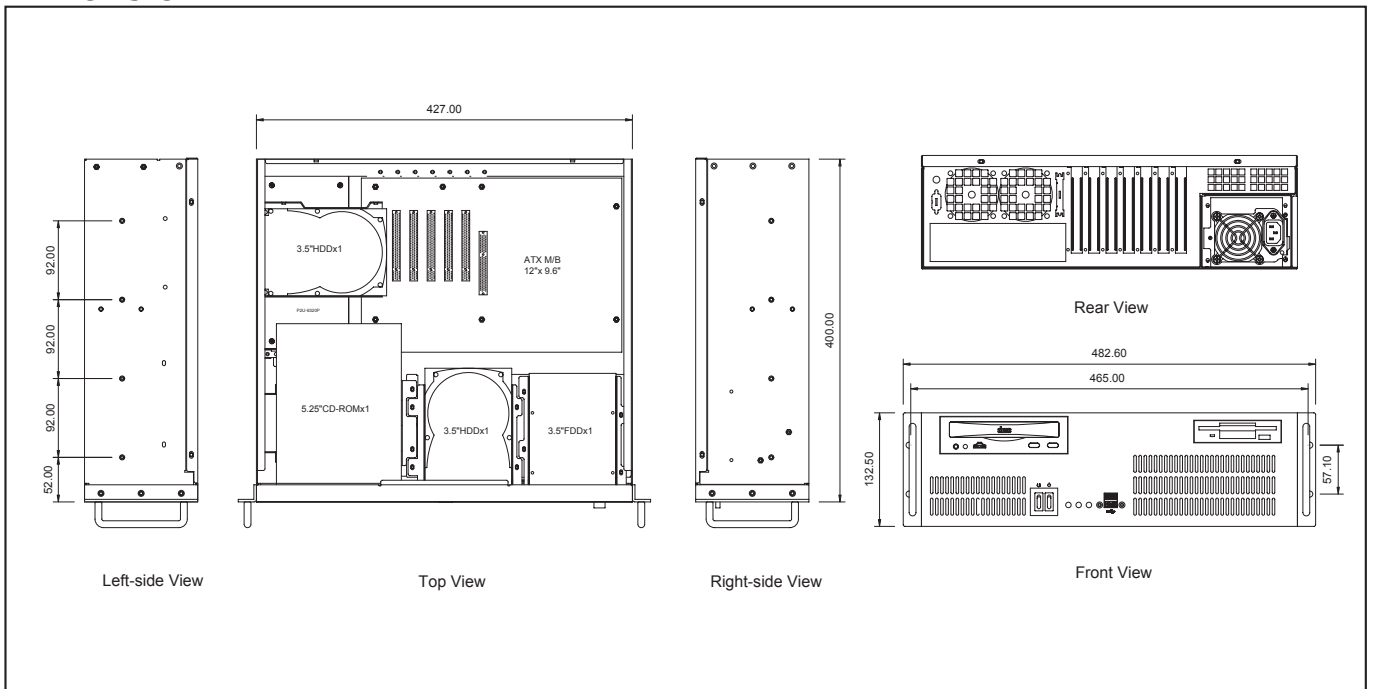

GHI-352

3U Rackmount Chassis



Specifications

- **EIA RS-310C 19" Rackmount Standard**
- **Construction:** Heavy Duty Cold Rolled Electroplated Steel
- **Color:** Black (Standard), Beige or Custom
- **System Boards:** Pentium 4, Athlon 64
- **Support ATX M/B (Max. to 12" x 9.6")**
- **Drive Capacity:** (Option A) 1xSlim CD-ROM & 1x3.5" FDD & 2x 3.5" Swappable Trays & 1x 3.5"HDD & 1x 3.5"HDD (Optional) (Option B) 1x5.25" CD-ROM & 2x3.5" Swappable Trays & 1x 3.5"HDD & 1x 3.5"HDD (Optional)
- **Power Supply(Optional):** 2U Single to up 600W or 2U Redundant up to 500W (Rear Installation) Max. Depth 300mm
- **Cooling:** 1x (80mm = 42.5CFM ea.) & 2x (40mm = 7CFM ea.) Fans & 1x (60mm = 23.5CFM ea.) Fan (Optional)
- **Connector Port (Front):** 2x USB Ports
- **Expansion Slots:** 7 slot
- **Indicators:** LEDs for Power ON/OFF, HDD Activity, LAN
- **Switch:** Power ON/OFF, System Reset on Rear Side
- **Dimensions (W x H x D):** 483 x 133 x 400mm (19" x 5.2" x 15.7")
- **Cuft:** 3.5
- **GW:** 12.8 kgs / 28.2 lbs
- **Carton Size(cm):** 58 x 28.5 x 59.9 (22.8" x 11.2" x 23.6")
- **Humidity:** 5% - 95% Non-condensing

Dimension

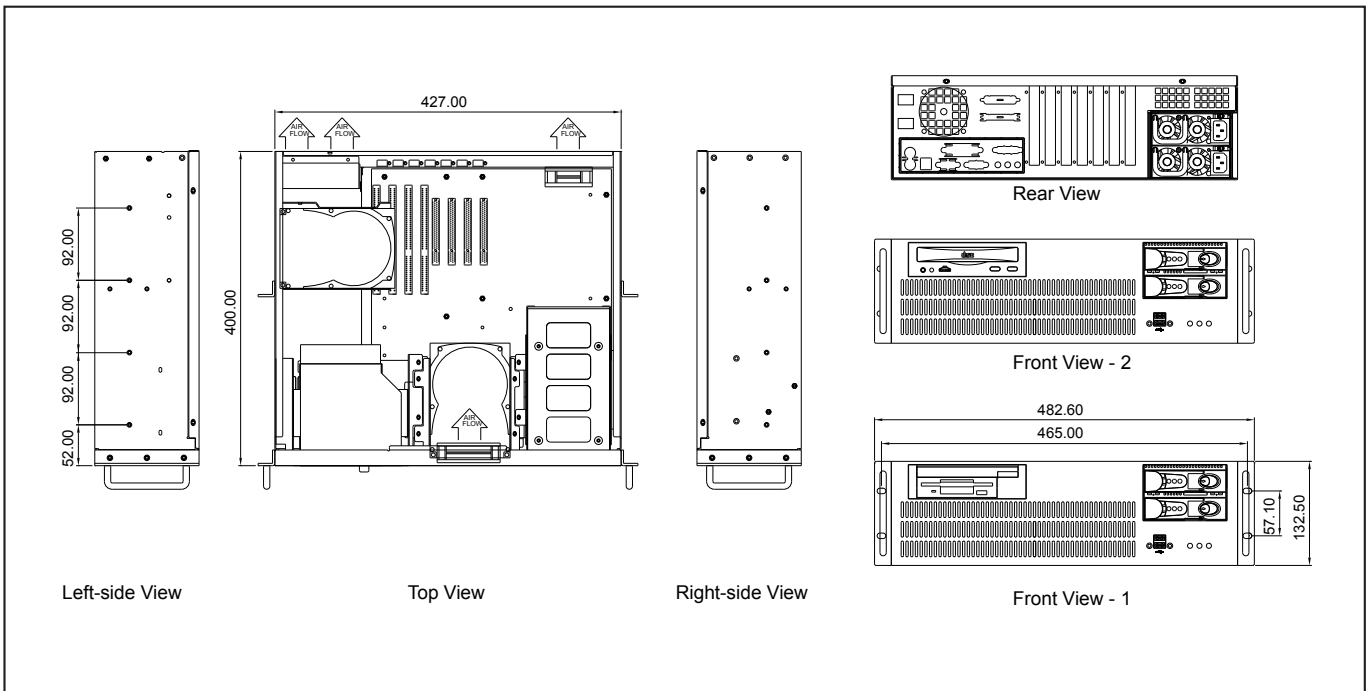

GHI-353

3U Rackmount Chassis



Specifications

- **EIA RS-310C 19" Rackmount Standard**
- **Construction:** Heavy Duty Cold Rolled Electroplated Steel
- **Color:** Black (Standard), Beige or Custom
- **System Boards:** Pentium 4, Dual Xeon, Athlon 64, Dual Opteron
- **Support EATX M/B (Max. to 12" x 10") SSI EEB 3.0**
- **Drive Capacity:**
(Option A): 1x 5.25" CD-ROM & 1x 3.5"FDD & 2 x 3.5"Swappable Trays
(Option B): 1x 5.25" Slim CD-ROM & 2x 3.5"FDD & 2x 3.5"Swappable Trays
- **Power Supply(Optional):** 2U Single or Redundant up to 400W ATX P/S (Rear Installation) Max. Depth 300mm
- **Cooling:** 1x (80mm = 42.5CFM ea.) & 2x (40mm = 7CFM ea.) & 2x (60mm = 23.5CFM ea.) (Optional) Fans
- **Connector Port (Front):** 2x USB Ports
- **Indicators:** LEDs for Power ON/OFF , HDD Activity, LAN
- **Switch:** Power ON/OFF Momentary (Rocker), System Reset
- **Dimensions (W x H x D):** 483 x 133 x 400mm (19" x 5.2" x 15.7")
- **Cuft:** 3.5
- **GW:** 11 kgs / 24.3 lbs
- **Carton Size(cm):** 58 x 28.5 x 59.9 (22.8" x 11.2" x 23.6")
- **Humidity:** 5% - 95% Non-condensing

Dimension

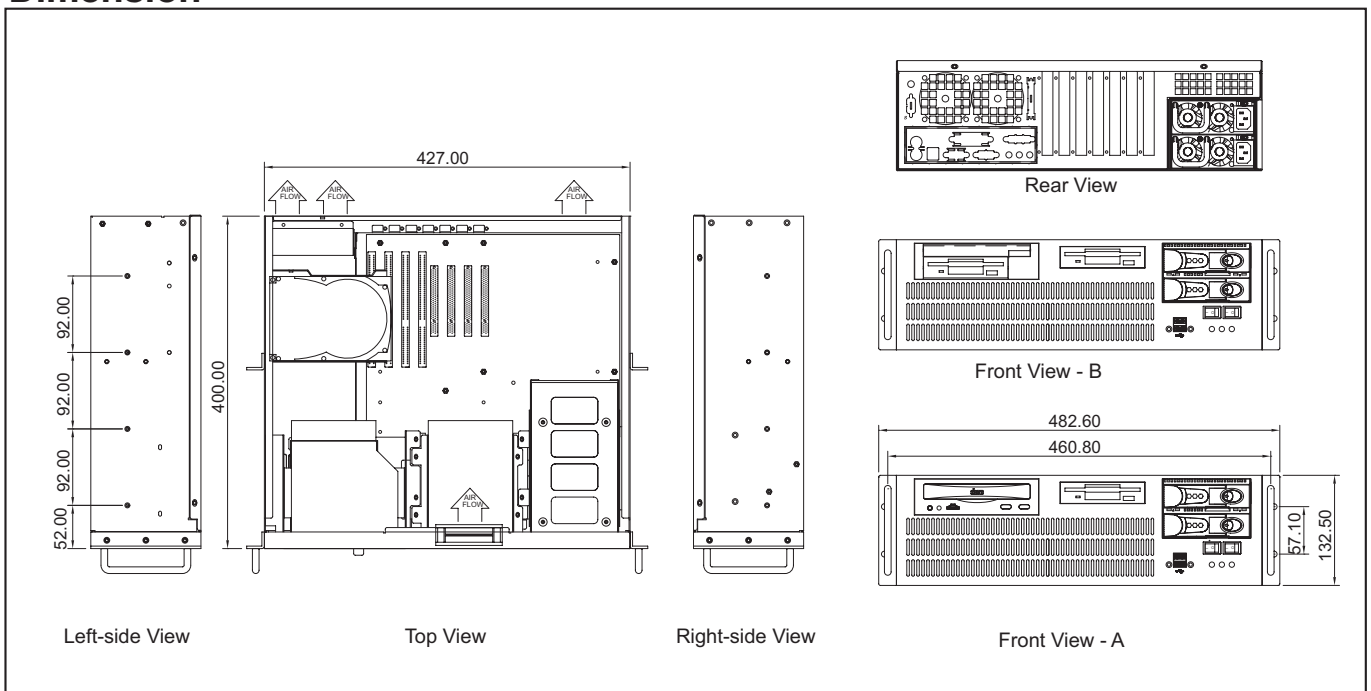

GHI-354

3U Rackmount Chassis



Specifications

- **EIA RS-310C 19" Rackmount Standard**
- **Construction:** Heavy Duty Cold Rolled Electroplated Steel
- **Color:** Black (Standard), Beige or Custom
- **System Boards:** Pentium 4, Athlon 64
- **Support Micro ATX (Max. to 9.6" x 9.6")**
- **Drive Capacity:** 1x 5.25" & 2x 3.5" HDD & 1x 3.5" HDD(Optional)
- **Power Supply(Optional):** PS/2 Single up to 700W or Mini Redundant up to 500W ATX P/S (Rear Installation) Max. Depth 300mm
- **Cooling:** 1x (120mm = 90CFM ea.) Fan & 1x (60mm = 23.5CFM ea.) Fan (Optional)
- **Connector Port (Front):** 2x USB Ports
- **Expansion Slots:** 4 slot
- **Indicators:** LEDs for Power ON/OFF, HDD Activity
- **Switch:** Power ON/OFF, System Reset
- **Dimensions (W x H x D):** 483 x 133 x 400mm (19" x 5.2" x 15.7")
- **Cuft:** 3.5
- **GW:** 11 kgs / 24.3 lbs
- **Carton Size(cm):** 58 x 28.5 x 59.9 (22.8" x 11.2" x 23.6")
- **Humidity:** 5% - 95% Non-condensing

Dimension

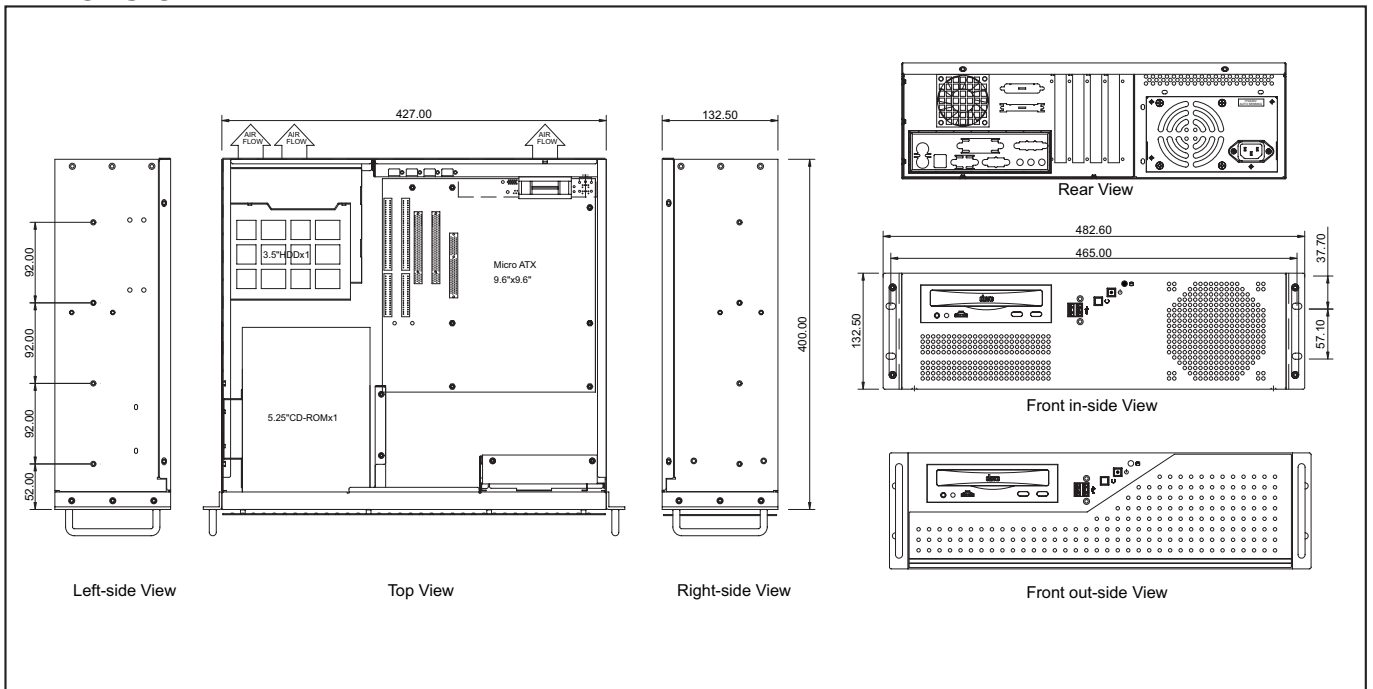

GHI-359

3U Rackmount Chassis



GHI-359-1



GHI-359-2

Specifications

- **EIA RS-310C 19" Rackmount Standard**
- **Construction:** Heavy Duty Cold Rolled Electroplated Steel
- **Color:** Black (Standard), Beige or Custom
- **System Boards:** Pentium 4, Dual Xeon, Athlon 64, Dual Opteron
- **Support EATX M/B (Max. to 12" x 10.5") SSI EEB 3.0**
- **Drive Capacity:** (GHI-359): 3x 5.25" & 6x 3.5" Swappable Trays
- **Drive Capacity:** (GHI-359-1): 5x 5.25" & 4x 3.5" HDD
- **Drive Capacity:** (GHI-359-2): 1x 5.25" & 12x 3.5" Swappable Trays
- **Drive Interface:** SATA, SCSI320, Multilane SATA or SAS
- **Power Supply(Optional):** 2U Single up to 650W or 2U Redundant up to 500W or 3U Single up to 950W ATX P/S or 3U Redundant up to 650W ATX P/S (Rear Installation) Max. Depth 300mm
- **Cooling:** 3x(40mm = 15.3CFM ea) & 2x (60mm = 23.5CFM ea.) Fan
- **Connector Port (Front):** 2x USB Ports
- **Expansion Slots:** 7 slot full length
- **Thermal Management Card:** GHA-CO04
- **Indicators:** LEDs for Power ON/OFF , HDD Activity, Fan, Temperature, LAN
- **Switch:** Power ON/OFF Momentary (Pushbutton), System Reset, Buzzer Reset
- **Dimensions (W x H x D):** 483 x 133 x 510mm (19" x 5.2" x 20.1")
- **Cuft:** 4.1
- **GW:** 14.9 kgs / 32.9 lbs
- **Carton Size(cm):** 67.5 x 29.2 x 59.5 (26.6" x 11.5" x 23.4")
- **Humidity:** 5% - 95% Non-condensing

Dimension

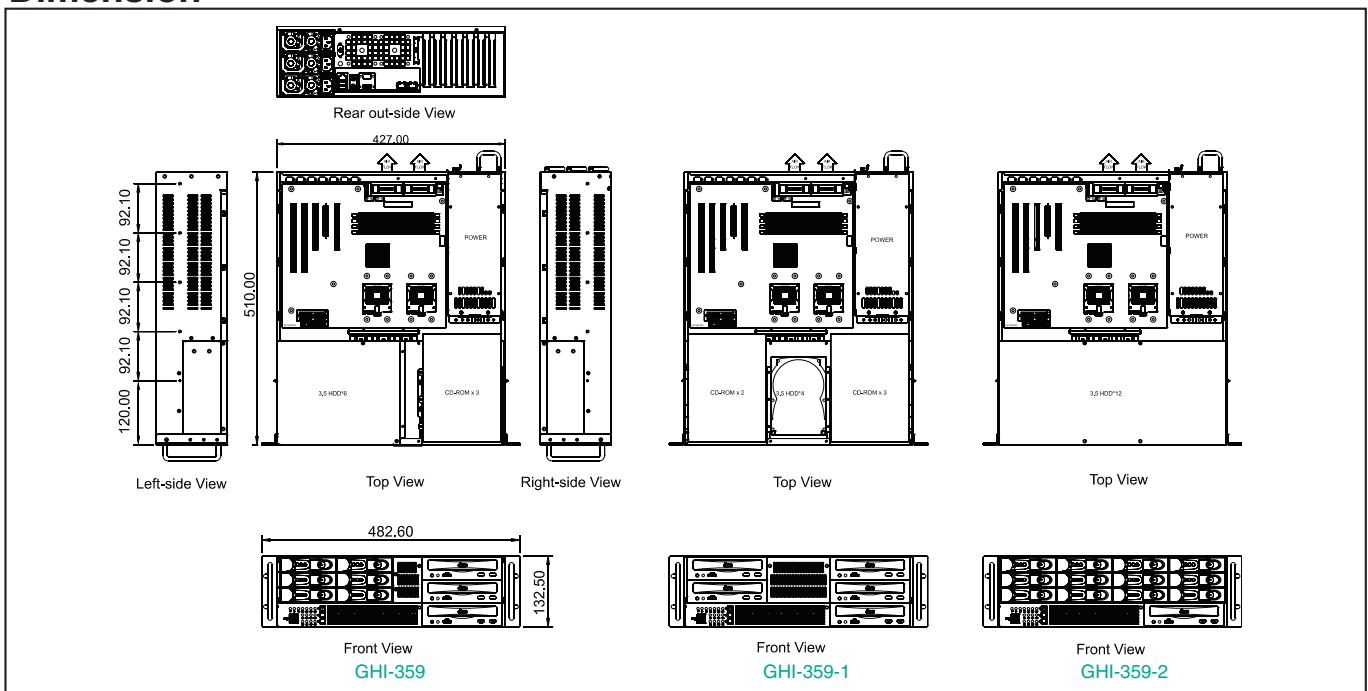

GHI-360

3U Rackmount Chassis



Specifications

- **EIA RS-310C 19" Rackmount Standard**
- **Construction:** Heavy Duty Cold Rolled Electroplated Steel
- **Color:** Black (Standard), Beige or Custom
- **System Boards:** Pentium 4, Dual Xeon, Athlon 64, Dual Opteron
- **Support EATX M/B (Max. to 12" x 13") SSI EEB 3.0**
- **Drive Capacity:** 26x Hot Swap 2.5" Drive Tray & 1x 5.25" CD-ROM
- **Drive Interface:** SATA, SCSI320 , SAS
- **Power Supply :** 2U Single up to 650W or 2U Redundant up to 500W ATX P/S (Rear Installation) Max. Depth 300mm
- **Cooling:** 4x (92mm = 51CFM ea.) & 1x (60mm = 23.5CFM ea.) & 2x (40mm = 15.3CFM ea.) Fans
- **Front Door:** Single Door With 2 Thumbscrews (Removable)
- **Connector Port (Front):** 2x USB Ports
- **Thermal Management Card:** GHA-CO04
- **Indicators:** LEDs for Power ON/OFF, HDD Power/Access, Fan, Temperature
- **Switch:** Power ON/OFF Momentary (Pushbutton), System Reset, Buzzer Reset
- **Dimensions (W x H x D):** 483 x 133 x 650mm (19" x 5.2" x 25.6")
- **Cuft:** 5.3
- **GW:** 20.9 kgs / 46.1 lbs
- **Carton Size(cm):** 59.4 x 31 x 81.8 (32.2" x 12.2" x 23.4")
- **Humidity:** 5% - 95% Non-condensing

Dimension

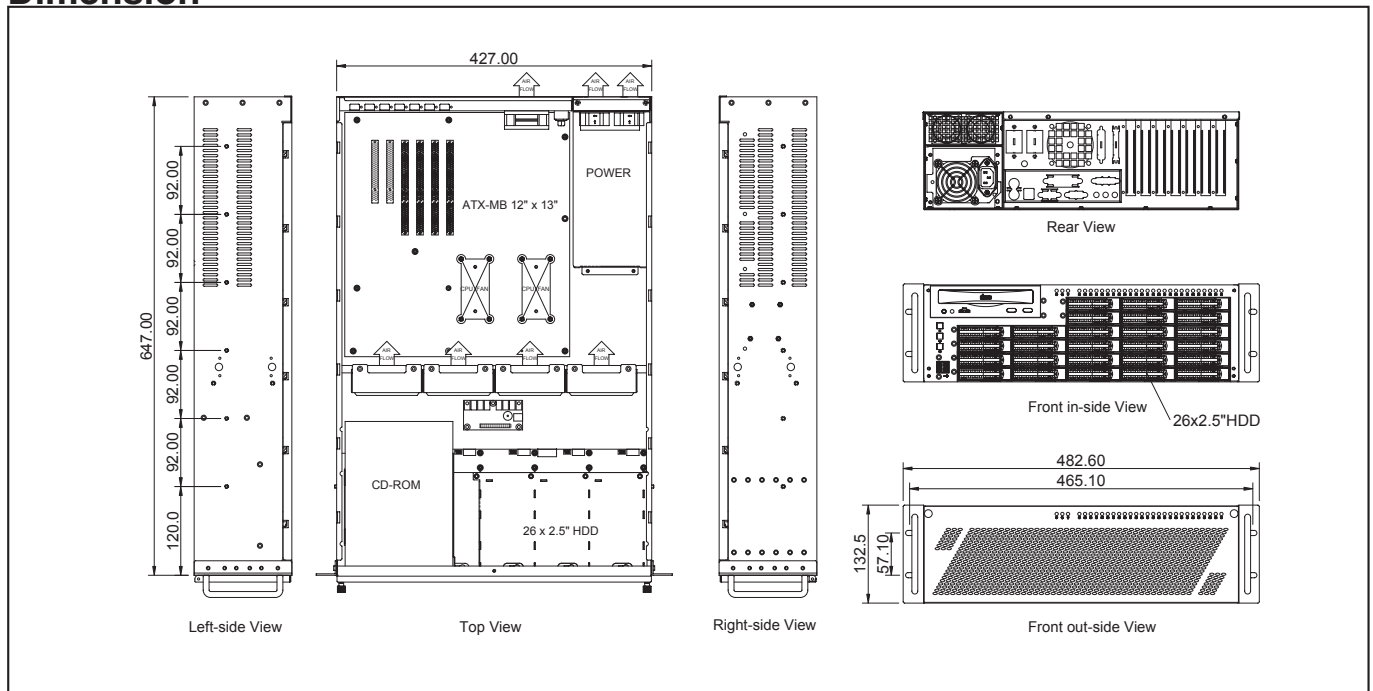

GHI-380

3U Rackmount Chassis

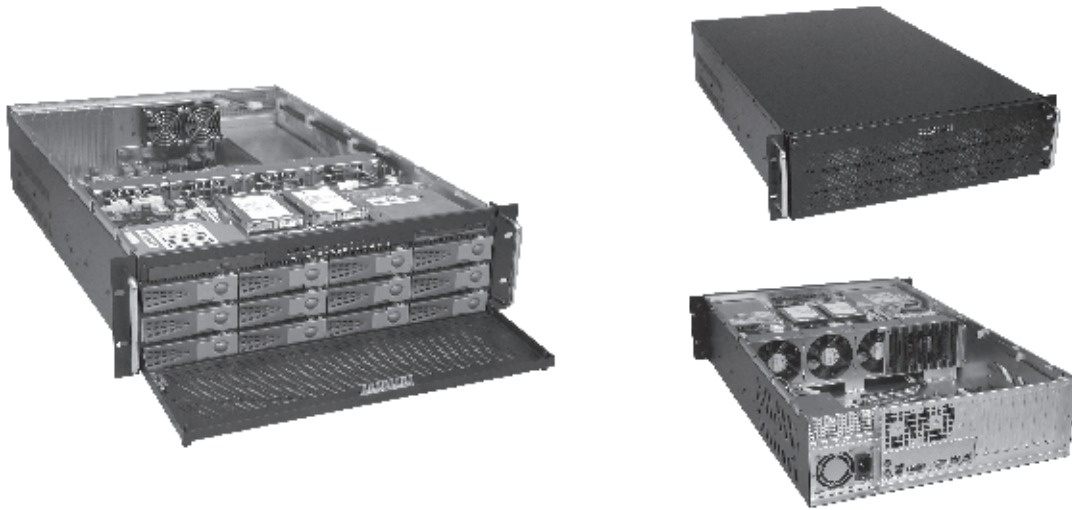

Specifications

- **EIA RS-310C 19" Rackmount Standard**
- **Construction:** Heavy Duty Cold Rolled Electroplated Steel
- **Color:** Black (Standard), Beige or Custom
- **System Boards:** Pentium 4, Dual Xeon, Athlon 64, Dual Opteron
- **Support EATX M/B (Max. to 12" x 13") SSI EEB 3.0**
- **Drive Capacity:** 1xSlim CD-ROM & 1xSlim FDD & 12x 3.5" Swappable Trays & 2x 2.5"HDD & 2x 3.5"HDD (Optional)
- **Drive Interface:** PATA, SATA, SCSI320, Multilane SATA or SAS
- **Power Supply(Optional):** 2U Single up to 650W or 2U Redundant up to 500W or 3U Single up to 950W ATX P/S or 3U Redundant up to 650W ATX P/S (Rear Installation) Max. Depth 300mm
- **Cooling:** 4x (92mm = 51CFM ea.) & 2x (60mm = 23.5CFM ea.) Fan
- **Front Door:** Single Door with 2 Thumbscrews(Removable)
- **Connector Port (Front):** 2x USB Ports
- **Expansion Slots:** 7 slot full length
- **Thermal Management Card:** GHA-CO04
- **Indicators:** LEDs for Power ON/OFF , HDD Activity, Fan, Temperature, LAN
- **Switch:** Power ON/OFF Momentary (Pushbutton), System Reset, Buzzer Reset
- **Dimensions (WxHxD):** 483 x 133 x 650mm (19" x 5.2" x 25.6")
- **Cuft:** 5.3
- **GW:** 22.0 kgs / 48.5 lbs
- **Carton Size(cm):** 81.8 x 31 x 59.4 (32.2" x 12.2" x 23.4")
- **Humidity:** 5% - 95% Non-condensing

Dimension

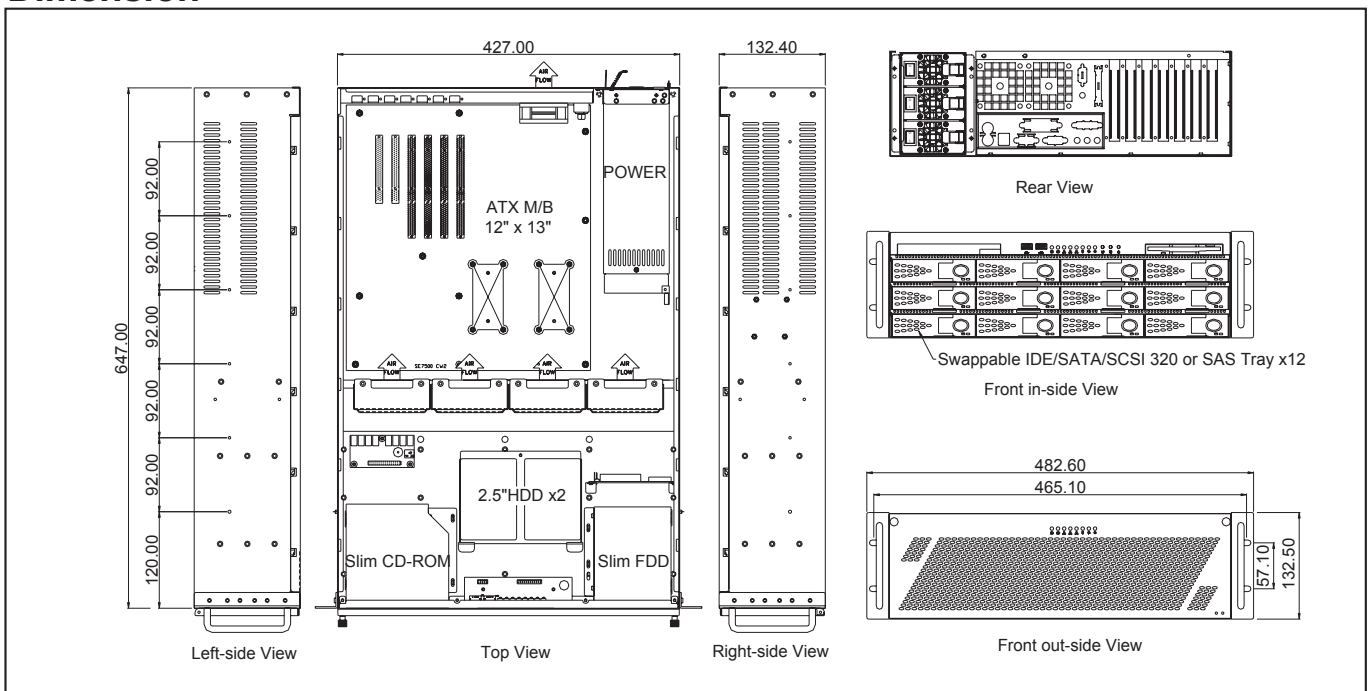

GHI-381

3U Rackmount Chassis



Specifications

- **EIA RS-310C 19" Rackmount Standard**
- **Construction:** Heavy Duty Cold Rolled Electroplated Steel
- **Color:** Black (Standard), Beige or Custom
- **System Boards:** Dual Xeon, Dual Opteron, Pentium 4, Dual Pentium III
- **Support EATX M/B(Max. to 12"x13")SSI EEB 3.0**
- **Drive Capacity:** 1x 5.25" & 1x Slim CD-ROM & 1x Slim FDD & 10x 3.5"Swappable Trays
- **Drive Interface:** PATA, SATA, SCSI320, Multilane SATA or SAS
- **Power Supply(Optional):** 2U Single up to 650W or 2U Redundant up to 500W or 3U Single up to 950W ATX P/S or 3U Redundant up to 650W ATX P/S (Rear Installation) Max. Depth 300mm
- **Cooling:** 4x (92cm = 51CFM ea.) & 2x (60mm = 23.5CFM ea.) Fan
- **Front Door:** Single Door with 2 Thumbscrews(Removable)
- **Connector Port (Front):** 2x USB Ports
- **Expansion Slots:** 7 slot full length
- **Thermal Management Card:** GHA-CO04
- **Indicators:** LEDs for Power ON/OFF, HDD Activity, Fan, Temperature, LAN
- **Switch:** Power ON/OFF Momentary (Pushbutton), System Reset, Buzzer Reset
- **Dimensions (WxHxD):** 483 x 133 x 650mm (19" x 5.2" x 25.6")
- **Cuft:** 5.3
- **GW:** 22.0kgs / 48.5lbs
- **Carton Size(cm):** 81.8 x 31 x 59.4 (32.2" x 12.2" x 23.4")
- **Humidity:** 5% - 95% Non-condensing

Dimension

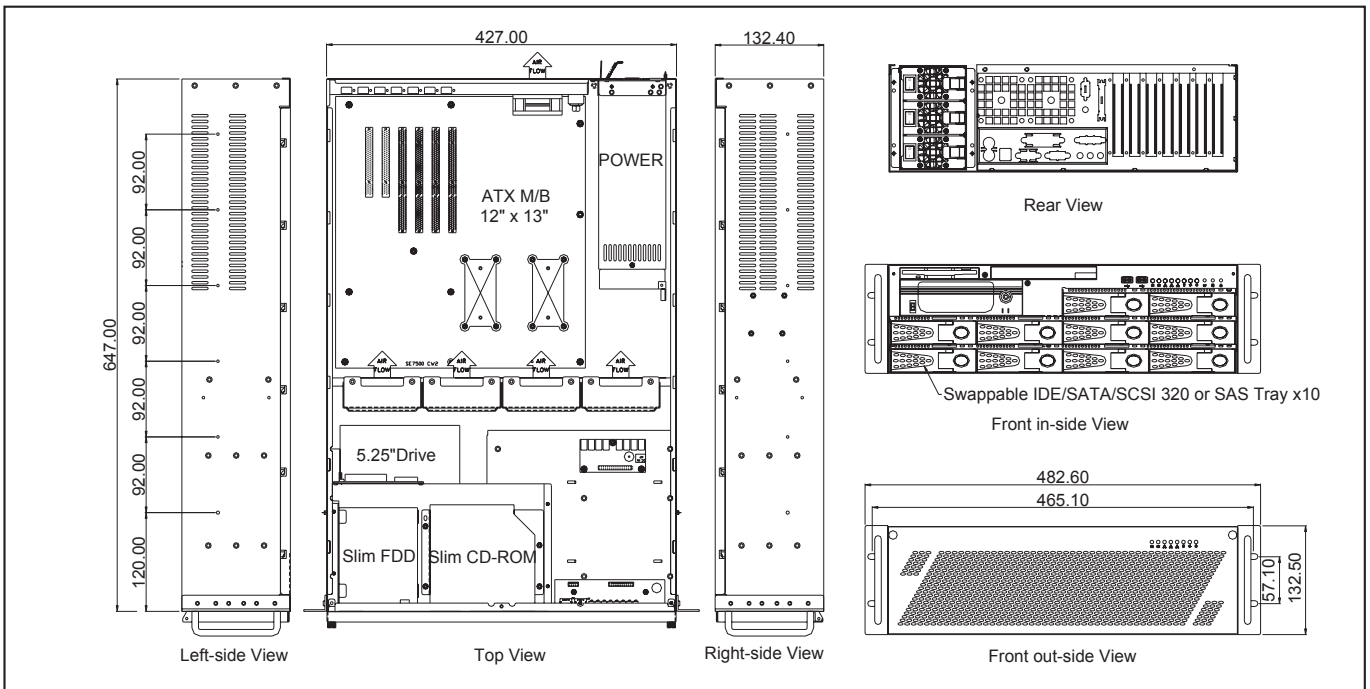

GHI-390

3U Rackmount Chassis

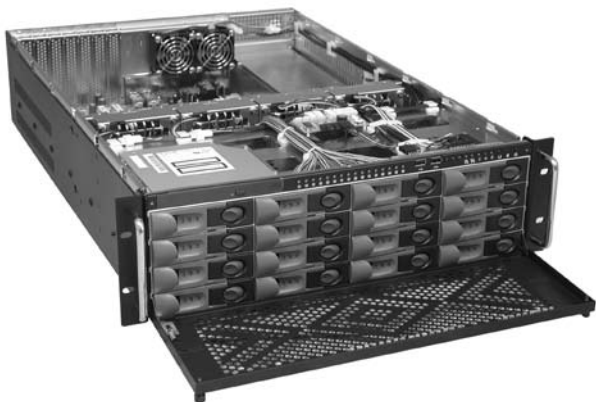

19" Rackmount

Specifications

- **EIA RS-310C 19" Rackmount Standard**
- **Construction:** Heavy Duty Cold Rolled Electroplated Steel
- **Color:** Black (Standard), Beige or Custom
- **System Boards:** Pentium 4, Dual Xeon, Athlon 64, Dual Opteron
- **Support EATX M/B (Max. to 12" x 13") SSI EEB 3.0**
- **Drive Capacity:** 1x Slim CD-ROM & 16x 3.5" Swappable Trays
- **Drive Interface:** SATA, SCSI320, Multilane SATA or SAS
- **Power Supply(Optional):** 2U Single up to 650W or 2U Redundant up to 500W or 3U Single up to 950W ATX P/S or 3U Redundant up to 650W ATX P/S (Rear Installation) Max. Depth 300mm
- **Cooling:** 4x (92mm = 51CFM ea.) & 2x (60mm = 23.5CFM ea.) Fan
- **Front Door:** Single Door with 2 Thumbscrews (Removable)
- **Connector Port (Front):** 2x USB Ports
- **Expansion Slots:** 7 Slot Full Length
- **Thermal Management Card:** GHA-CO04
- **Indicators:** LEDs for Power ON/OFF , HDD Activity, Fans, Temperature, LAN
- **Switch:** Power ON/OFF Momentary (Pushbutton), System Reset, Buzzer Reset
- **Dimensions (WxHxD):** 483 x 133 x 650mm (19" x 5.2" x 25.6")
- **Cuft:** 5.3
- **GW:** 22.0kgs / 48.5lbs
- **Carton Size(cm):** 81.8 x 31 x 59.4 (32.2" x 12.2" x 23.4")
- **Humidity:** 5% - 95% Non-condensing

Dimension

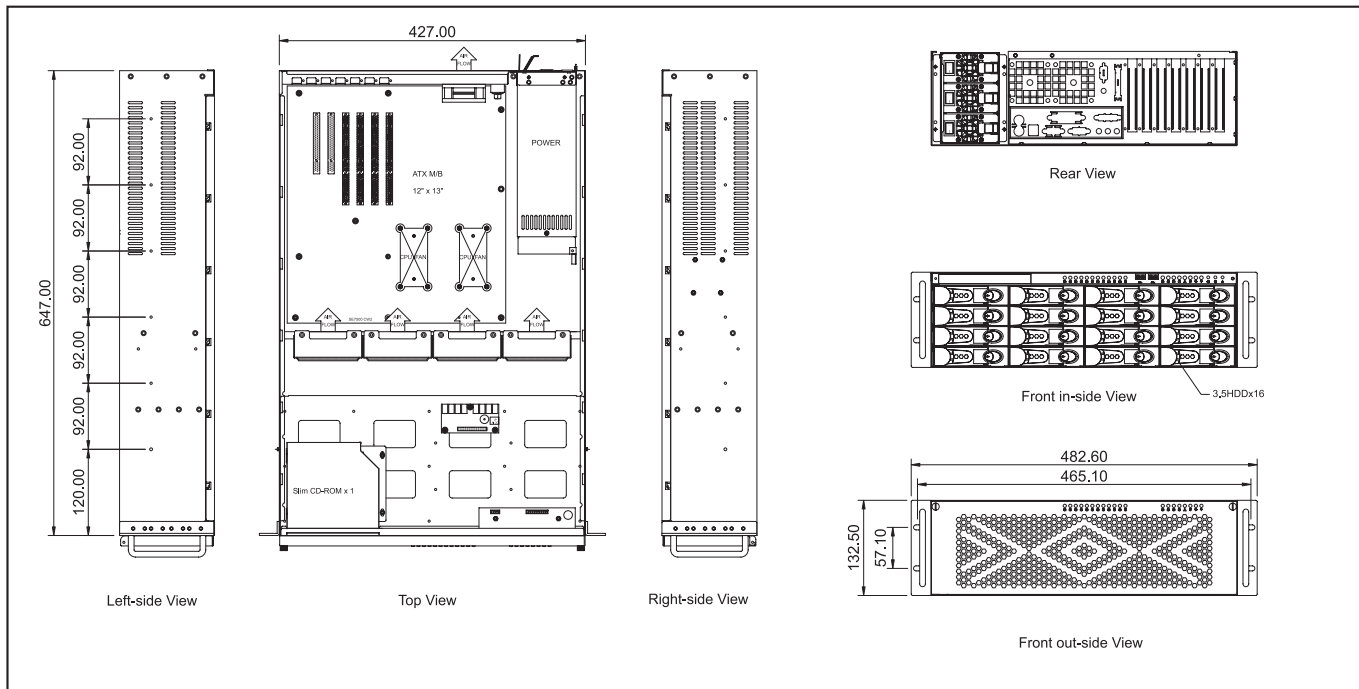

GHI-A30

3U Rackmount Chassis



Specifications

- **EIA RS-310C 19" Rackmount Standard**
- **Construction:** Heavy Duty Cold Rolled Electroplated Steel
- **Color:** Black (Standard), Beige or Custom
- **System Boards:** Pentium 4, Dual Xeon, Athlon 64, Dual Opteron, Quad Opteron
- **Supports ATX M/B (Max. to 12" x 9.6")**
- **Drive Capacity:** 2x 5.25"CD-ROM & 1x 3.5"FDD & 2x 3.5"HDD & 4x 3.5"Swappable Trays
- **Power Supply (Optional):** 2U Single up to 600W or 2U Redundant up to 500W ATX P/S(Rear Installation) Max. Depth 300mm
- **Cooling:** 1x (120mm = 90CFM ea.) & 1x (80mm = 42.5CFM ea.) & 2x (60mm 23.5CFM ea.) & 2x (40mm 7CFM ea.) Fans
- **Front Door:** Single Door With Thumbscrews
- **Connector Port (Front):** 2x USB Ports
- **Indicators:** LEDs for Power ON/OFF, HDD Power/Access/ Fault, LAN
- **Flexible Hold Down Bar Designed**
- **Switch:** Power ON/OFF Momentary(Rocker), System Reset
- **Dimensions (W x H x D):** 483 x 177 x 624mm (19" x 7" x 24.5")
- **Cuft:** 3.4
- **GW:** 15.9 kgs / 35.1 lbs
- **Carton Size (cm):** 70 x 24.2 x 56 (27.6" x 9.5" x 22.1")
- **Humidity:** 5% - 95% Non-condensing

Dimension

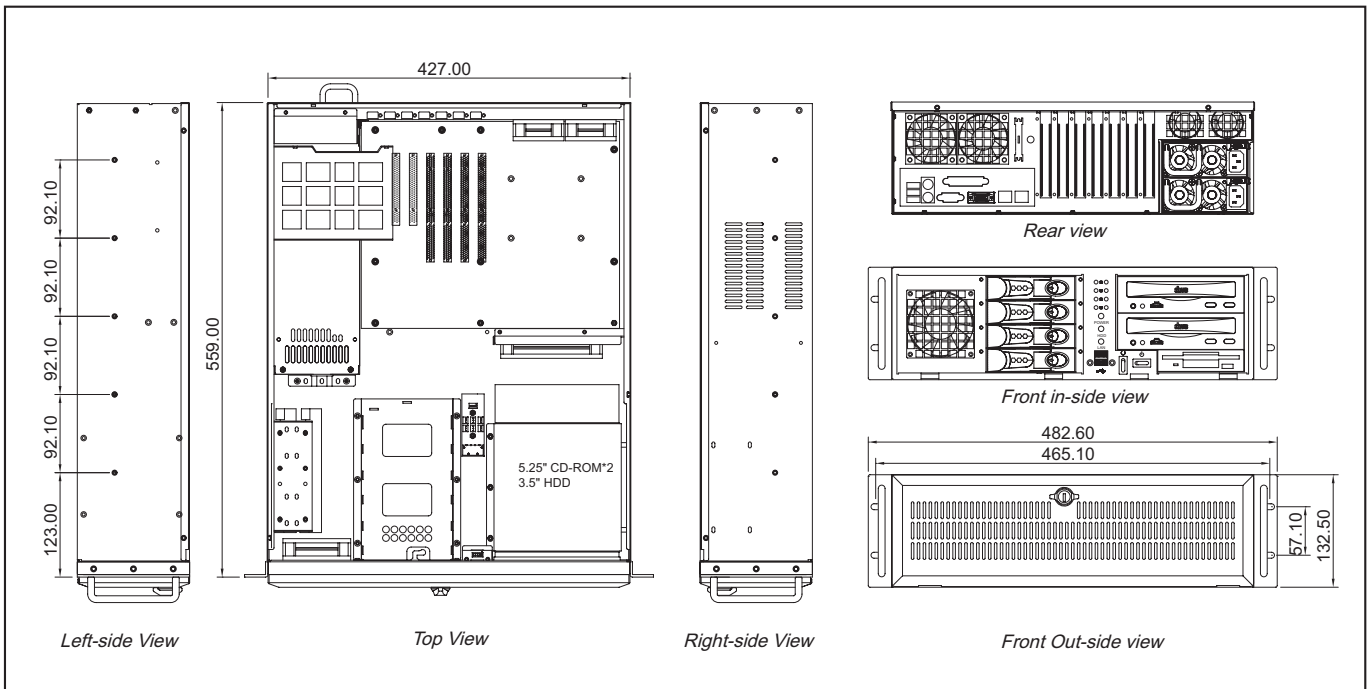

GHI-A31

3U Rackmount Chassis

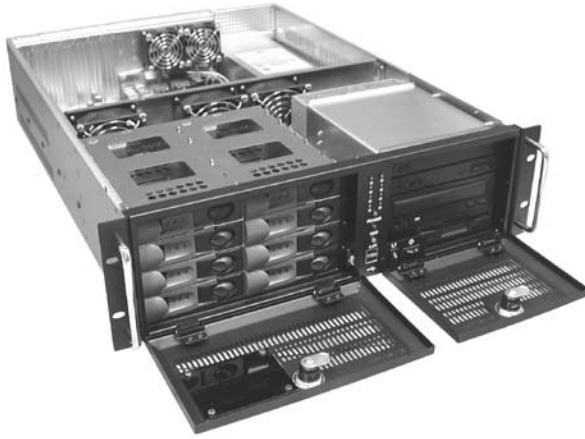

19" Rackmount

Specifications

- **EIA RS-310C 19" Rackmount Standard**
- **Construction:** Heavy Duty Cold Rolled Electroplated Steel
- **Color:** Black (Standard), Beige or Custom
- **System Boards:** Pentium 4, Dual Xeon, Athlon 64, Dual Opteron
- **Support EATX M/B (Max. to 12" x 13") SSI EEB 3.0**
- **Drive Capacity:** 2x 5.25" & 1x 3.5"FDD & 8x 3.5" Swappable Trays
- **Drive Interface:** SATA, SCSI320 , Multilane SATA or SAS
- **Power Supply(Optional):** 2U Single up to 650W or 2U Redundant up to 500W ATX P/S (Rear Installation) Max. Depth 300mm
- **Cooling:** 3x (80mm = 42.5CFM ea) & 2x (60mm = 23.5CFM ea.) Fan
- **Front Door:** 2 Doors With Thumb Twist Keylock
- **Connector Port (Front):** 2x USB Ports
- **Expansion Slots:** 7 slot full length
- **Indicators:** LEDs for Power ON/OFF , HDD Activity, LAN
- **Switch:** Power ON/OFF Momentary (Pushbutton), System Reset
- **Dimensions (W x H x D):** 483 x 133 x 610mm (19" x 5.2" x 24.0")
- **Cuft:** 4.8
- **GW:** 19.1 kgs / 42.1 lbs
- **Carton Size(cm):** 59.5 x 29.2 x 77.5 (23.4" x 11.5" x 30.5")
- **Humidity:** 5% - 95% Non-condensing

Dimension

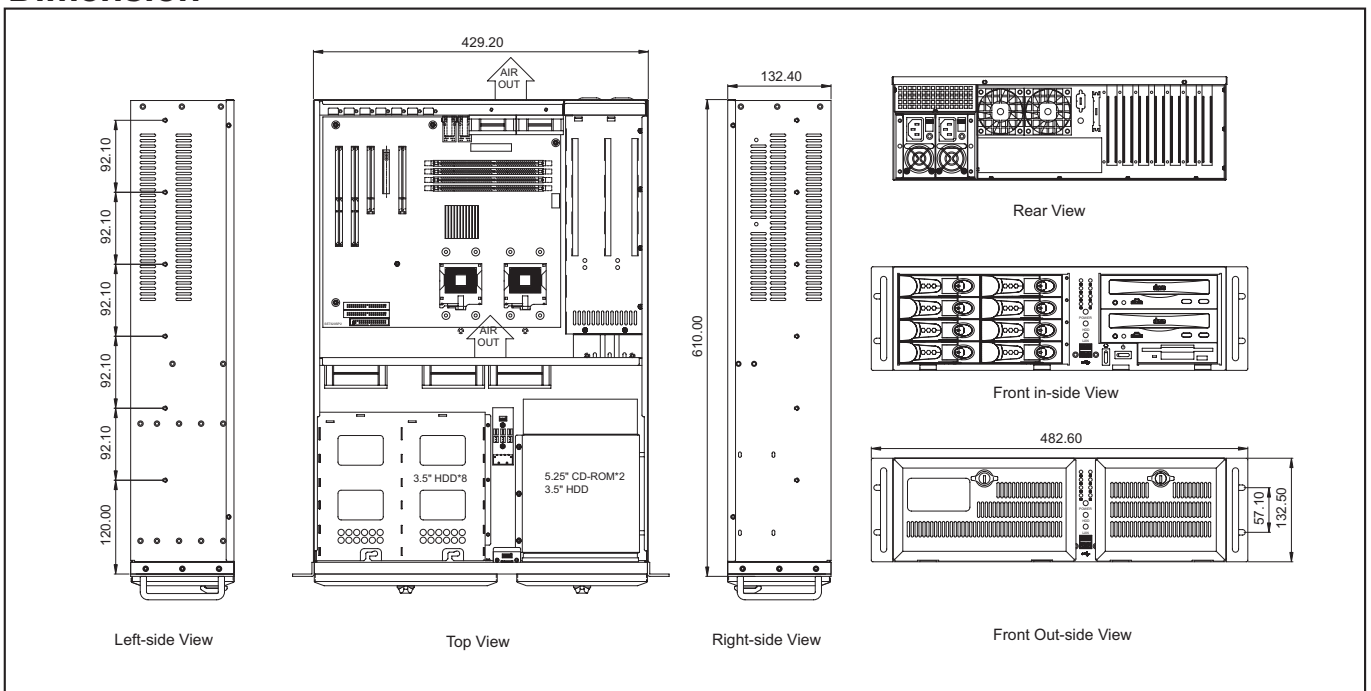

GHI-A32

3U Rackmount Chassis



Specifications

- **EIA RS-310C 19" Rackmount Standard**
- **Construction:** Heavy Duty Cold Rolled Electroplated Steel
- **Color:** Black (Standard), Beige or Custom
- **System Boards:** Pentium 4, Dual Xeon, Athlon 64, Dual Opteron
- **Support EATX M/B (Max. to 12" x 13") SSI EEB 3.0**
- **Drive Capacity:** 2x 5.25" & 1x 3.5" FDD & 8x 3.5" Swappable Trays
- **Drive Interface:** PATA, SATA, SCSI320, Multilane SATA or SAS
- **Power Supply(Optional):** 2U Single up to 650W or 2U Redundant up to 500W ATX P/S (Rear Installation) Max. Depth 300mm
- **Cooling:** 3x(92mm = 51CFM ea) & 2x (60mm = 23.5CFM ea.) Fan
- **Front Door:** 2 Doors With Thumb Twist Keylock
- **Connector Port (Front):** 2x USB Ports
- **Expansion Slots:** 7 slot full length
- **Indicators:** LEDs for Power ON/OFF, HDD Activity, LAN
- **Switch:** Power ON/OFF Momentary (Pushbutton), System Reset
- **Dimensions (W x H x D):** 483 x 133 x 650mm (19" x 5.2" x 25.6")
- **Cuft:** 5.3
- **GW:** 19 kgs / 41.9 lbs
- **Carton Size(cm):** 59.4 x 31 x 81.8 (23.4" x 12.2" x 32.2")
- **Humidity:** 5% - 95% Non-condensing

Dimension

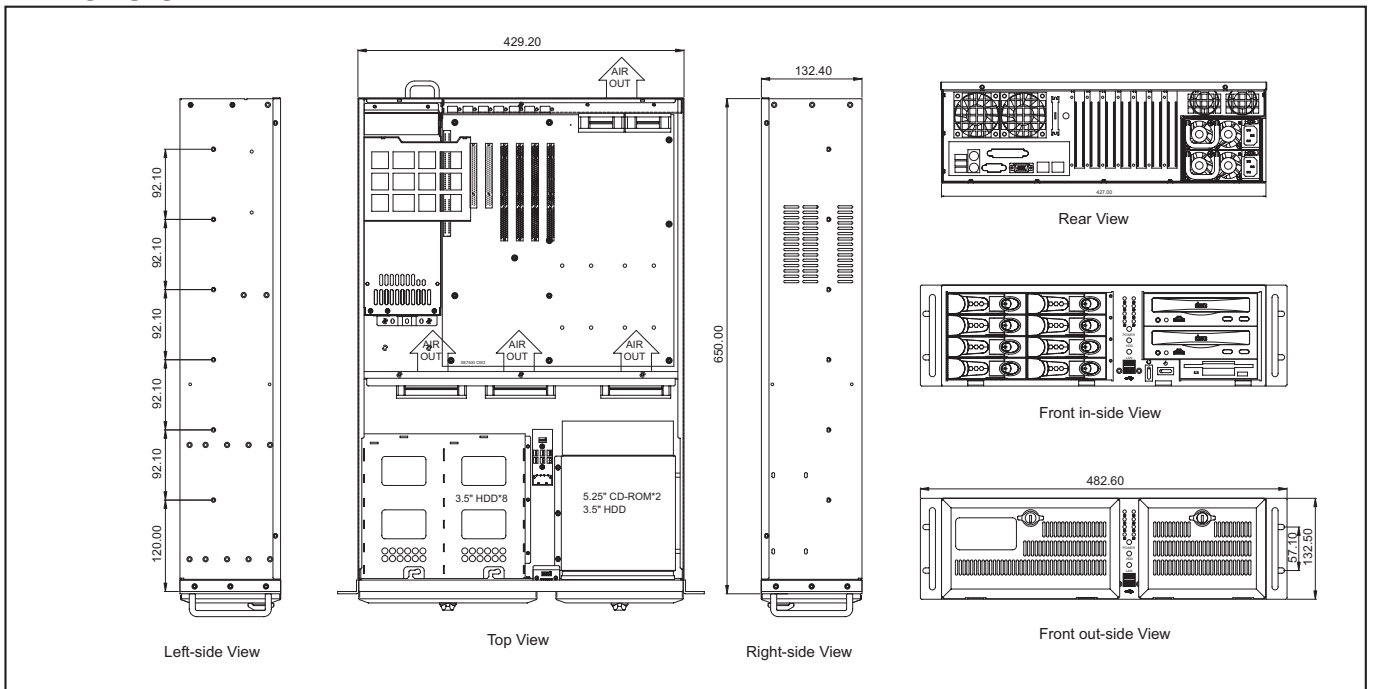

GHI-A33

3U Rackmount Chassis



19" Rackmount

Specifications

- **EIA RS-310C 19" Rackmount Standard**
- **Construction:** Heavy Duty Cold Rolled Electroplated Steel
- **Color:** Black (Standard), Beige or Custom
- **System Boards:** Pentium 4, Dual Xeon, Athlon 64, Dual Opteron
- **Support ATX M/B (Max. to 12" x 9.6") SSI EEB 3.0**
- **Drive Capacity:** 2x 5.25" & 1x 3.5" FDD & 6x 3.5" Swappable Trays
- **Drive Interface:** PATA, SATA, SCSI320, Multilane SATA or SAS
- **Power Supply(Optional):** 2U Single up to 700W or 2U Redundant up to 500W ATX P/S (Rear Installation) Max. Depth 300mm
- **Cooling:** 2x (120mm = 90CFM ea.) & 2x (60mm = 23.5CFM ea.) Fans
- **Front Door:** Single Door With Keylock
- **Connector Port (Front):** 2x USB Ports
- **Expansion Slots:** 7 slot full length
- **Indicators:** LEDs for Power ON/OFF, HDD Activity, LAN
- **Switch:** Power ON/OFF Momentary (Rocker), System Reset
- **Dimensions (W x H x D):** 483 x 133 x 560mm (19" x 5.2" x 22.1")
- **Cuft:** 4.5
- **GW:** 16.8 kgs / 37.0 lbs
- **Carton Size(cm):** 56 x 30.5 x 74 (22.1" x 12" x 29.1")
- **Humidity:** 5% - 95% Non-condensing

Dimension

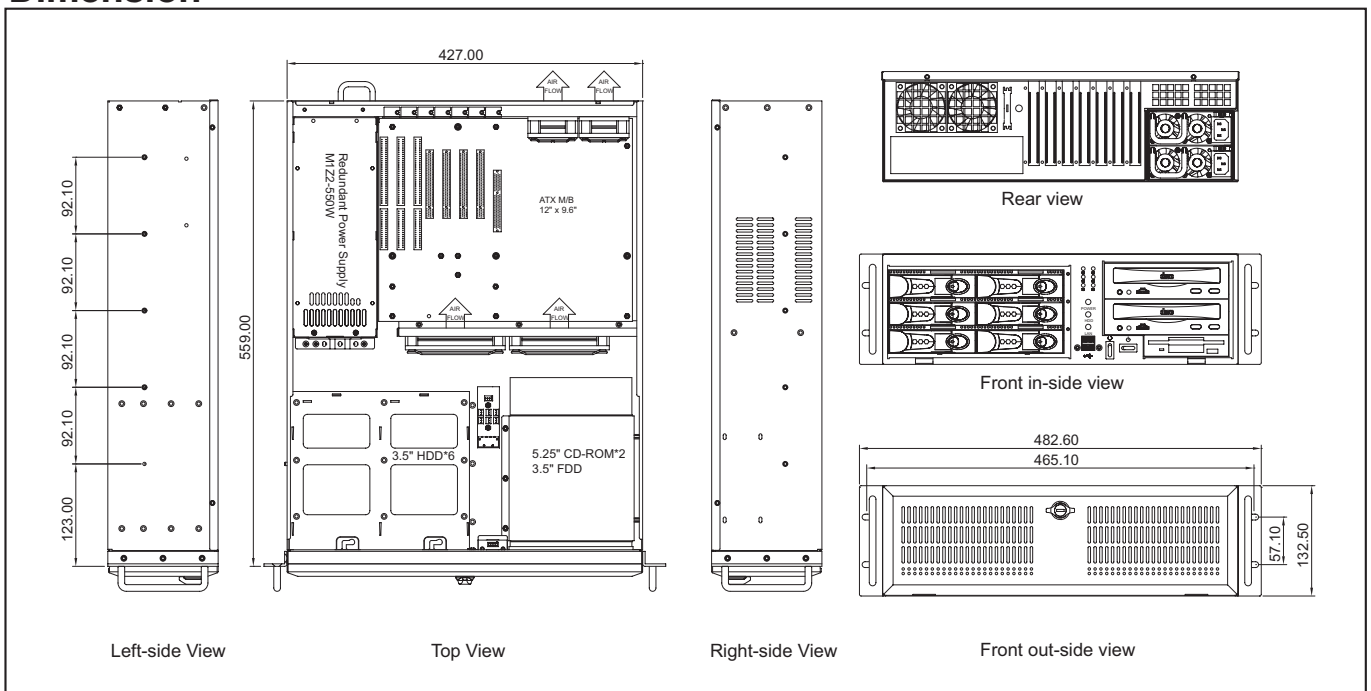

GHI-C30

3U Rackmount Chassis



Specifications

- **EIA RS-310C 19" Rackmount Standard**
- **Construction:** Heavy Duty Cold Rolled Electroplated Steel
- **Color:** Black (Standard), Beige or Custom
- **System Boards:** Pentium 4, Dual Xeon, Athlon 64, Dual Opteron
- **Support EATX M/B (Max. to 12" x 13") SSI EEB 3.0**
- **Drive Capacity:** 1x Slim CD-ROM & 16x 3.5" Swappable Trays
- **Drive Interface:** PATA, SATA, SCSI320 , Multilane SATA or SAS
- **Power Supply(Optional):** 2U Single up to 650W or 2U Redundant up to 500W or 3U Single up to 950W ATX P/S or 3U Redundant up to 650W ATX P/S (Rear Installation) Max. Depth 300mm
- **Cooling:** 4x (92mm = 51CFM ea.) & 2x (60mm = 23.5CFM ea.) Fans
- **Front Door:** Single Door With 2 Thumbscrews (Removeable)
- **Connector Port (Front):** 2x USB Ports
- **Expansion Slots:** 7 Slot Full Length
- **Thermal Management Card:** GHA-CO04
- **Indicators:** LEDs for Power ON/OFF , HDD Activity on Tray , LEDs for Fans, Temperature, LAN on Front Panel
- **Switch:** Power ON/OFF (Momentary Pushbutton), System Reset, Buzzer Reset
- **Dimensions (W x H x D):** 483 x 133 x 650mm (19" x 5.2" x 25.6")
- **Cuft:** 5.3
- **GW:** 21.4 kgs / 47.2 lbs
- **Carton Size(cm):** 81.8 x 31 x 59.4 (32.2" x 12.2" x 23.4")
- **Humidity:** 5% - 95% Non-condensing

Dimension

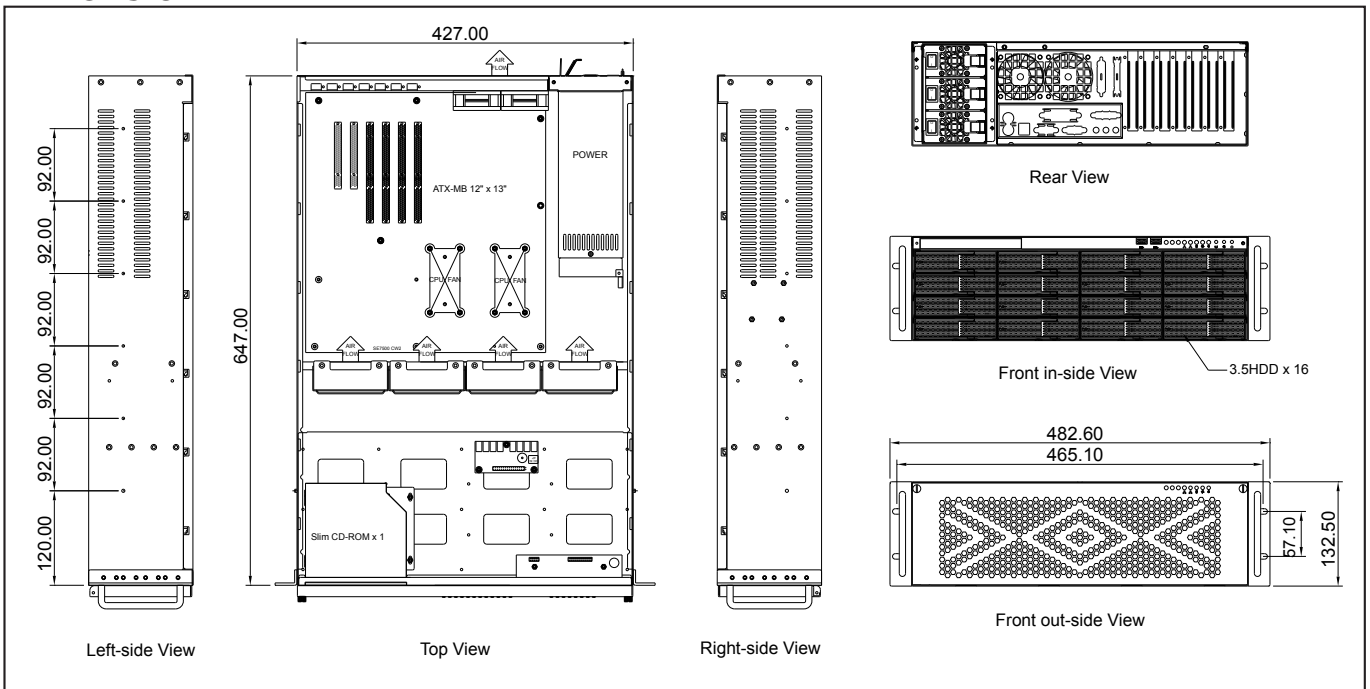

GHI-M30

3U Rackmount Chassis



19" Rackmount

Specifications

- **EIA RS-310C 19" Rackmount Standard**
- **Construction:** Heavy Duty Cold Rolled Electroplated Steel
- **Color:** Black (Standard), Beige or Custom
- **System Boards:** Pentium 4, Athlon 64, Dual Xeon, Dual Opteron
- **Support ATX M/B (Max. to 12" x 9.6")**
- **Drive Capacity:** 2x 5.25" CD-ROM & 1x 3.5" FDD & 3x 3.5" HDD
- **Power Supply (Optional):** 2U Single up to 600W or 2U Redundant up to 500W ATX P/S Max. Depth 300mm
- **Cooling:** 2x (60 mm = 23.5CFM ea.) & 2x (40 mm = 7CFM ea.) Fans
- **Front Door:** Single Door With Thumb Twist Keylock
- **Connector Port (Front):** 2x USB Ports
- **LCD Size:** 6.4" 640 x 480 Digital TFT Panel With Touch Screen
- **Display Colors:** 262,144 Colors
- **Indicators:** LEDs for Power ON/OFF, HDD Activity, LAN
- **Switch:** Power ON/OFF, System Reset
- **Dimensions (W x H x D):** 483 x 133 x 524mm (19" x 5.2" x 20.6")
- **Cuft:** 4.2
- **GW:** 15.0 kgs / 33.1 lbs
- **Carton Size(cm):** 58.8 x 28.5 x 70.3 (23.2" x 11.2" x 27.7")
- **Humidity:** 5% - 95% Non-condensing

Dimension

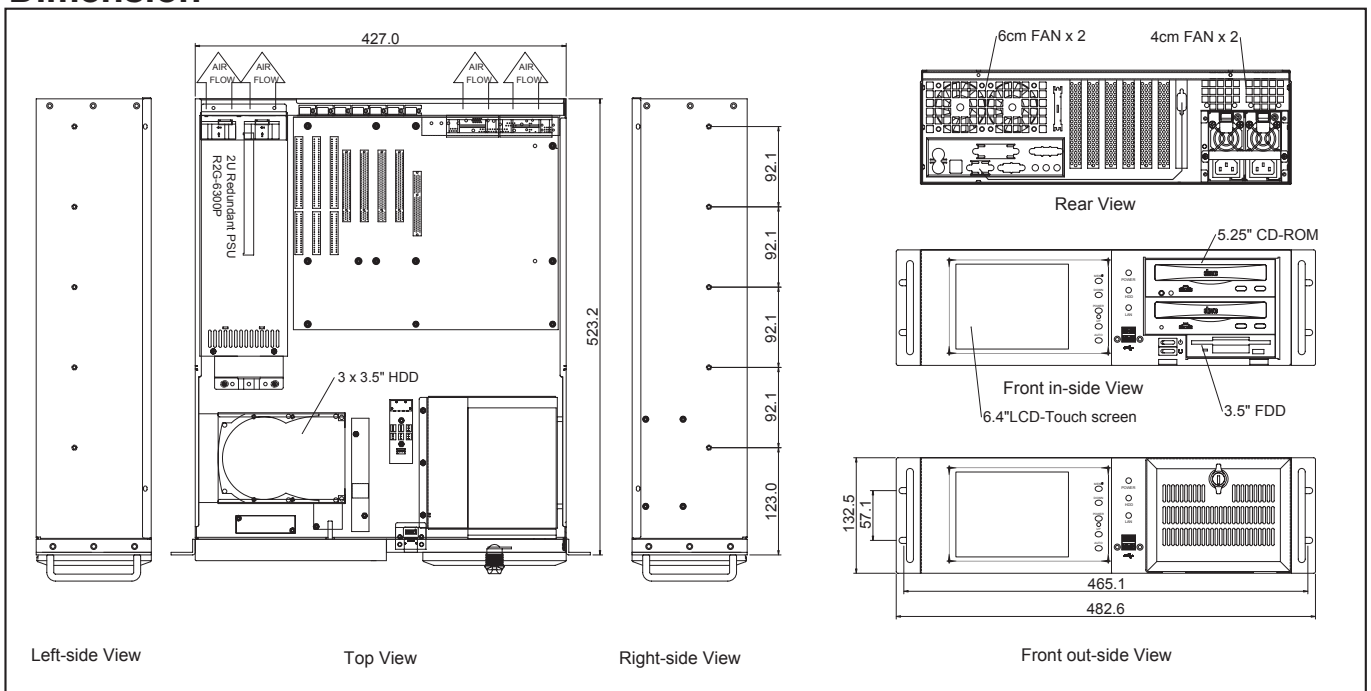

GHI-M31

3U Rackmount Chassis



Specifications

- **EIA RS-310C 19" Rackmount Standard**
- **Construction:** Heavy Duty Cold Rolled Electroplated Steel
- **Color:** Black (Standard), Beige or Custom
- **System Boards:** Pentium 4, Athlon 64, Dual Xeon, Dual Opteron
- **Support ATX M/B (Max. to 12" x 9.6")**
- **Drive Capacity:** 2x 5.25" CD-ROM & 1x 3.5" FDD & 3x 3.5" HDD
- **Power Supply (Optional):** 2U Single up to 600W or 2U Redundant up to 500W ATX P/S Max. Depth 300mm
- **Cooling:** 2x (60 mm = 23.5CFM ea.) & 2x (40 mm = 7CFM ea.) Fans
- **Front Door:** Single Door With Thumb Twist Keylock
- **Connector Port (Front):** 2x USB Ports
- **LCD Size:** 7" TFT with 800*480 Resolution With Touch Screen
- **Display Colors:** 262,144 colors
- **Indicators:** LEDs for Power ON/OFF, HDD Activity, LAN
- **Switch:** Power ON/OFF, System Reset
- **Dimensions (W x H x D):** 483 x 133 x 524mm (19" x 5.2" x 20.6")
- **Cuft:** 4.2
- **GW:** 15 kgs / 33.1 lbs
- **Carton Size(cm):** 58.8 x 28.5 x 70.3 (23.2" x 11.2" x 27.7")
- **Humidity:** 5% - 95% Non-condensing

Dimension

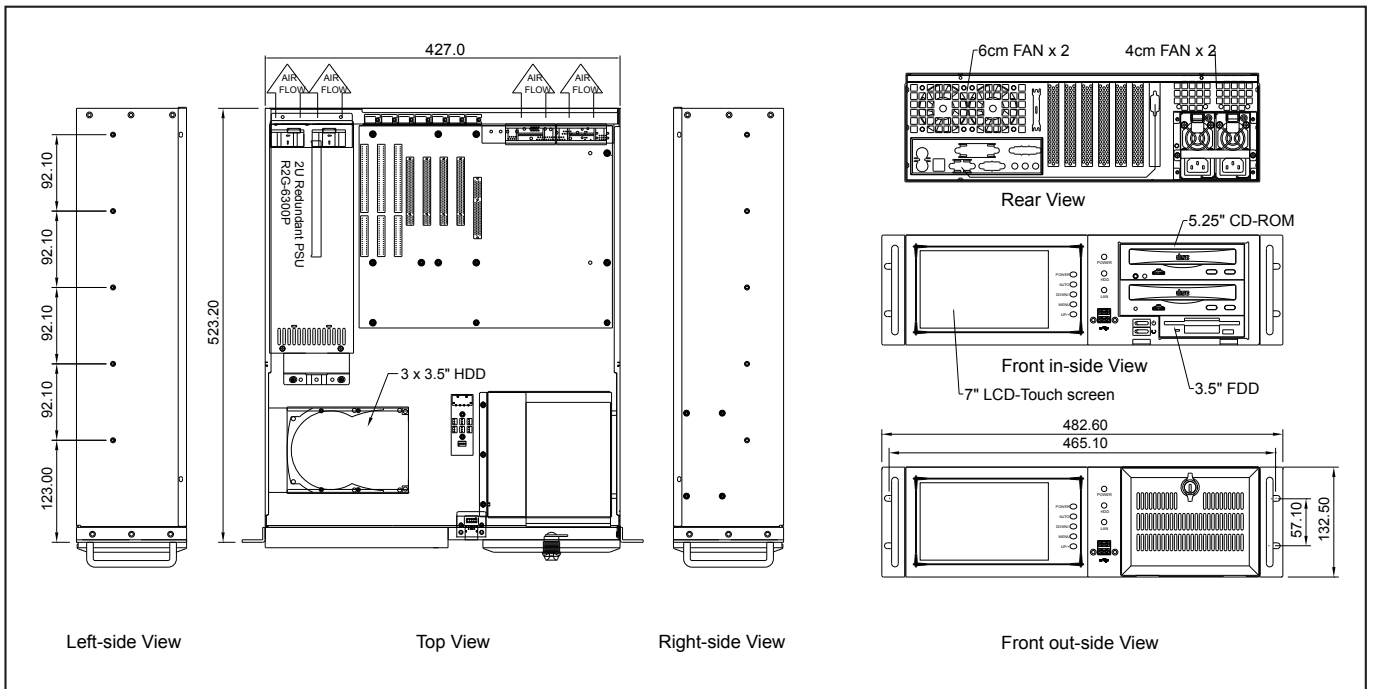

GH-400ATX/400S

4U Rackmount Chassis



Specifications

- **EIA RS-310C 19" Rackmount Standard**
- **Construction:** Heavy Duty Cold Rolled Electroplated Steel
- **Color:** Black (Standard), Beige or Custom
- **System Boards:** Pentium 4, Dual Xeon, Athlon 64, Dual Opteron
- **Support ATX M/B (Max. to 12" x 9.6") (400ATX)**
- **Support 14-slot Passive Backplane (400S)**
- **Drive Capacity:** 2x 5.25" & 1x 3.5" & 1x 3.5" HDD
- **Power Supply (Optional):** PS/2 Size Single up to 700W ATX P/S (Rear Installation) Max. Depth 200mm
- **Cooling:** 2x (80mm = 42.5CFM ea.) Fans
- **Front Door:** Drive Panel Door with Keylock
- **Air Filter:** Inside Front Panel (Washable)
- **Connector Port (Front):** 1x PS/2 for GH-400S & 2x USB (Optional) Ports
- **Expansion Slots:** 7 slot (400ATX) or 14 Slot (400S)
- **Indicators:** LED for Power ON/OFF, HDD Activity
- **Flexible Hold Down Bar Designed**
- **Switch:** Power ON/OFF Momentary (Pushbutton), System Reset
- **Dimensions (WxHxD):** 483x177x426mm (19" x 7" x 16.8")
- **Cuft:** 4.4
- **GW:** 16.8 kgs / 37.0 lbs
- **Carton Size(cm):** 61.8 x 34 x 59 (24.3" x 13.4" x 23.2")
- **Humidity:** 5% - 95% Non-condensing

Dimension

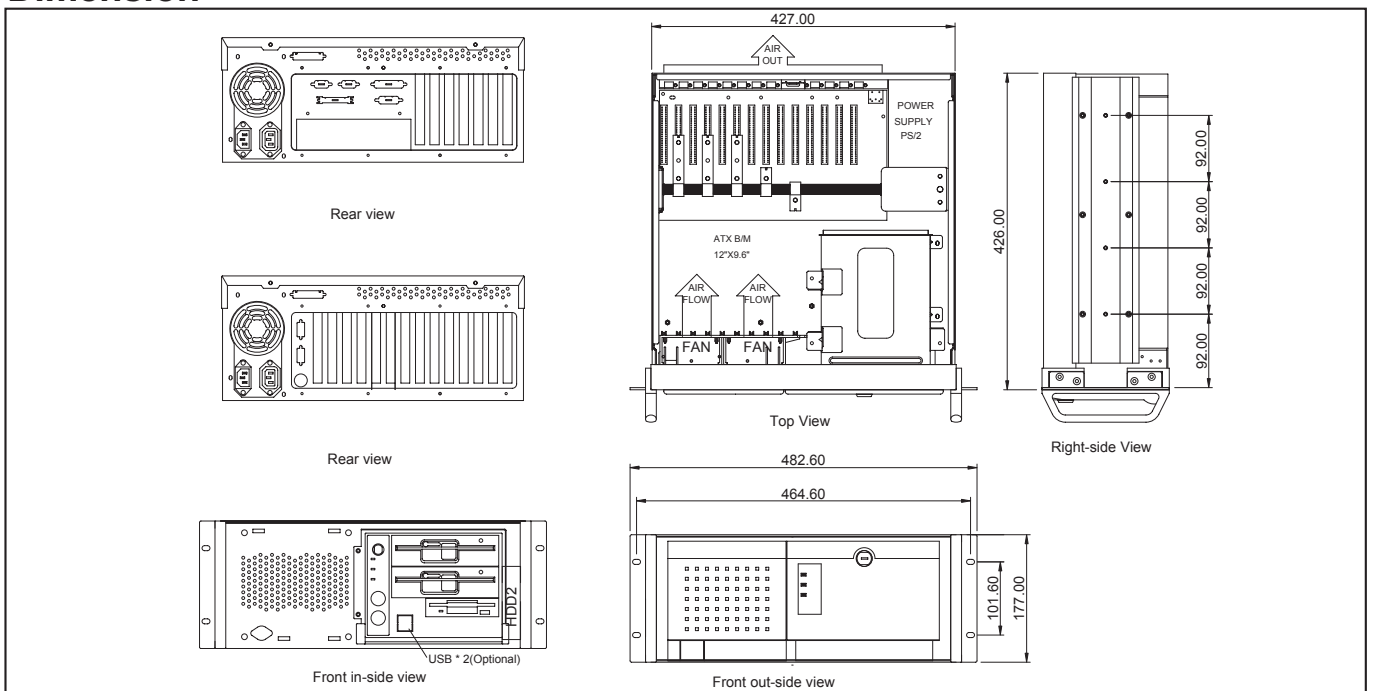

GH-402ATXR/402SR

4U Rackmount Chassis



Specifications

- **EIA RS-310C 19" Rackmount Standard**
- **Construction:** Heavy Duty Cold Rolled Electroplated Steel
- **Color:** Black (Standard), Beige or Custom
- **System Boards:** Pentium 4, Dual Xeon, Athlon 64, Dual Opteron
- **Support ATX M/B (Max. to 12" x 9.6") (402ATXR)**
- **Support 14/15-slot Passive Backplane (402SR)**
- **Drive Capacity:** 3x 5.25" & 1x 3.5"
- **Power Supply (Optional):** PS/2 Size Single up to 700W or Mini Redundant up to 500W ATX P/S(Rear Installation) Max. Depth 200mm
- **Cooling:** 2x (92mm = 51CFM ea.) Hot Swap Fans
- **Front Door:** Drive Panel Door With Keylock
- **Air Filter:** Inside Front Panel (Washable)
- **Connector Port (Front):** 1x PS/2 for GH-402SR & 2x USB (Optional) Ports
- **Indicators:** LEDs for Power ON/OFF, HDD Activity
- **Switch:** Power ON/OFF, Momentary(Pushbutton), System Reset
- **Flexible Hold Down Bar Designed**
- **Dimensions (WxHxD):** 483x177x451mm (19" x 7" x 17.8")
- **Cuft:** 4.4
- **GW:** 16.5 kgs / 36.4 lbs
- **Carton Size(cm):** 61.8 x 34 x 59 (24.3" x 13.4" x 23.2")
- **Humidity:** 5% - 95% Non-condensing

Dimension

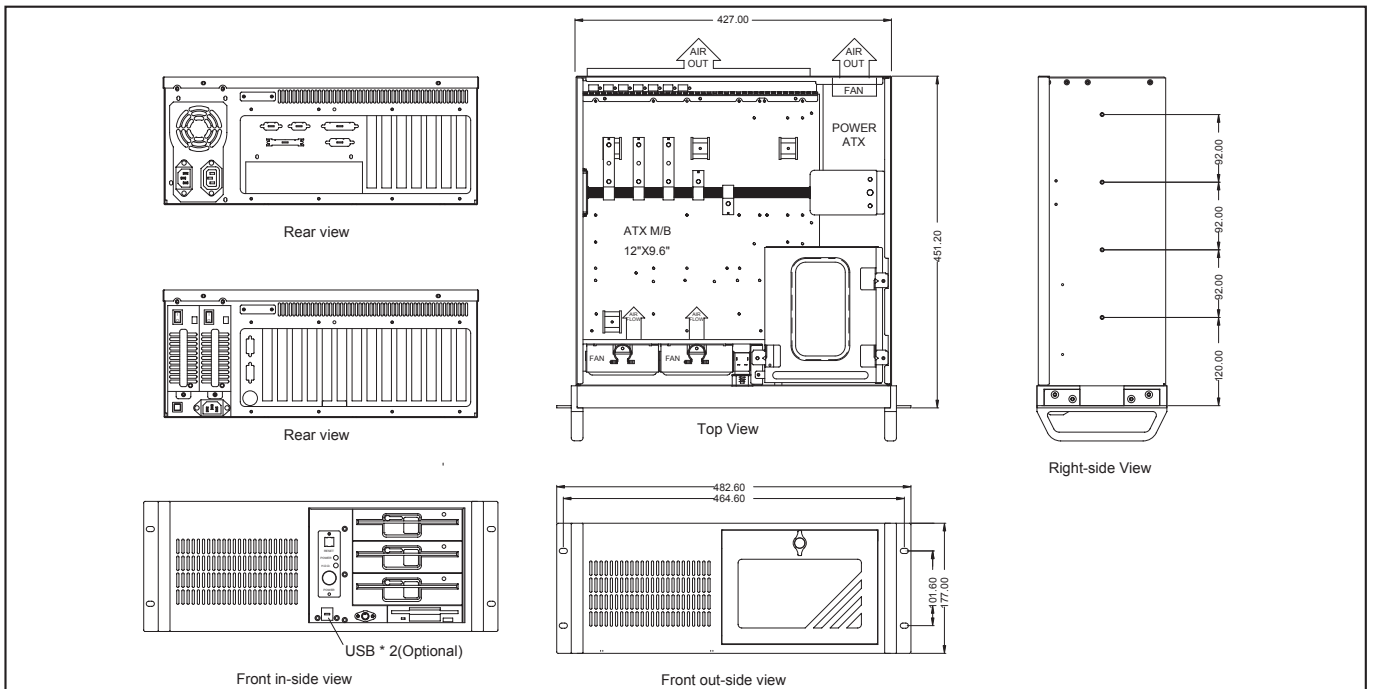

GHI-403ATXR/403SR

4U Rackmount Chassis



19" Rackmount

Specifications

- **EIA RS-310C 19" Rackmount Standard**
- **Construction:** Heavy Duty Cold Rolled Electroplated Steel
- **Color:** Black (Standard), Beige or Custom
- **System Boards:** Pentium 4, Dual Xeon, Athlon 64, Dual Opteron
- **Support ATX M/B (Max. to 12" x 9.6") (403ATXR)**
- **Support 14/15-slot Passive Backplane (403SR)**
- **Drive Capacity:** 3x 5.25" & 1x 3.5"
- **Power Supply (Optional):** PS/2 Size Single up to 700W ATX or Mini Redundant up to 500W ATX P/S (Rear Installation) Max. Depth 200mm
- **Cooling:** 2x (92mm = 51CFM ea.) Hot Swap Fans
- **Front Door:** Single Door with 1 Thumb Twist keylock
- **Air Filter:** Inside Front Door (Washable)
- **Connector Port (Front):** 1x PS/2 for GH-403SR & 2x USB (Optional) Ports
- **Indicators:** LEDs for Power ON/OFF, HDD Activity
- **Flexible Hold Down Bar Designed**
- **Switch:** Power ON/OFF, Momentary(Pushbutton), System Reset
- **Dimensions (WxHxD):** 483 x 177 x 451mm (19" x 7" x 17.8")
- **Cuft:** 4.4
- **GW:** 17.2 kgs / 37.9 lbs
- **Carton Size(cm):** 61.8 x 34 x 59 (24.3" x 13.4" x 23.2")
- **Humidity:** 5% - 95% Non-condensing

Dimension

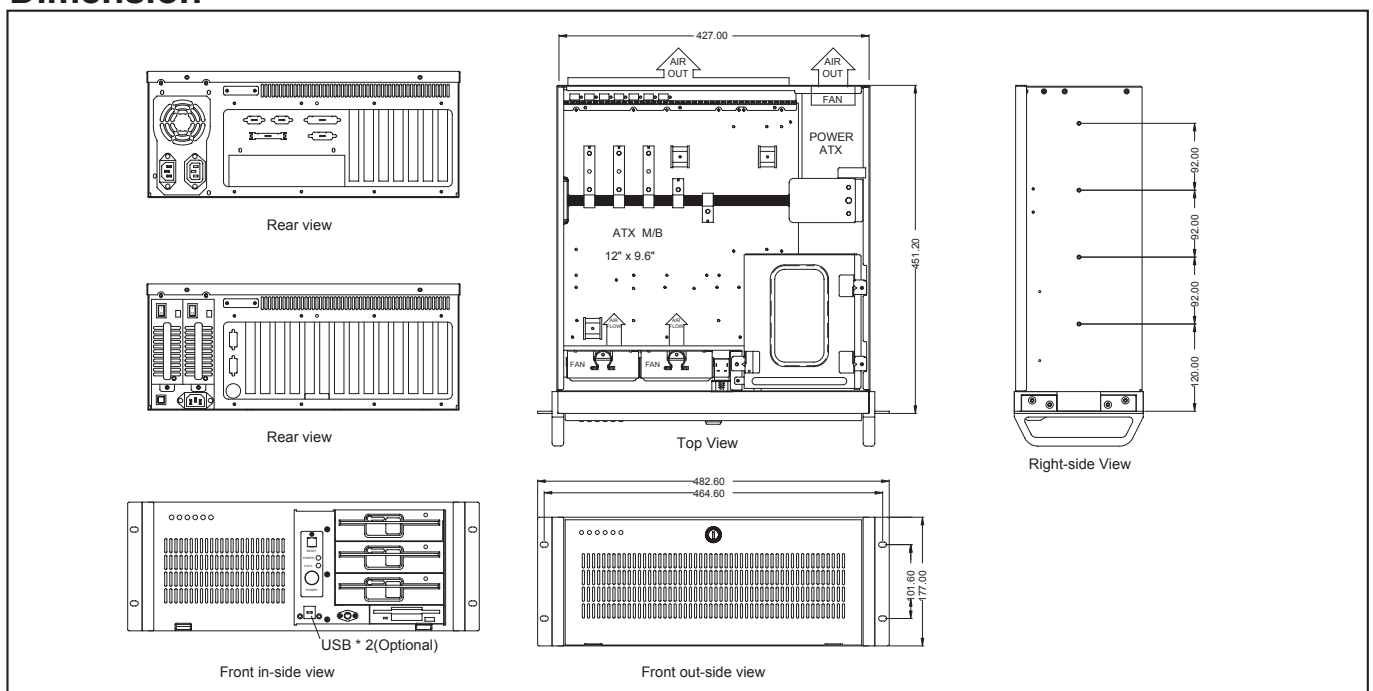

GHI-404

4U Rackmount Chassis



Specifications

- **EIA RS-310C 19" Rackmount Standard**
- **Construction:** Heavy Duty Cold Rolled Electroplated Steel
- **Color:** Black (Standard), Beige or Custom
- **System Boards:** Pentium 4, Dual Xeon, Athlon 64, Dual Opteron
- **Support EATX M/B (Max. to 12" x 13") SSI EEB 3.0**
- **Drive Capacity:** 2x 5.25"CD-ROM & 1x 3.5" HDD (Hidden)
- **Power Supply (Optional):** PS/2 Size Single up to 700W or Mini Redundant up to 500W ATX P/S (Rear Installation) Max. Depth 300mm
- **Cooling:** 2x (90mm = 51CFM ea.) Fans & 2x (60mm = 23.5CFM ea.) Fans (Optional)
- **Front Door:** Single Door With 2 Thumbscrews
- **Air Filter:** Inside Front Panel (Washable)
- **Connector Port (Front):** 2x USB Ports
- **Indicators:** LEDs for Power ON/OFF, HDD Activity
- **Flexible Hold Down Bar Designed**
- **Switch:** Power ON/OFF , System Reset
- **Dimensions (W x H x D):** 483 x 177 x 408mm (19" x 7" x 16.1")
- **Cuft:** 4.2
- **GW:** 14.9 kgs / 32.9 lbs
- **Carton Size(cm):** 59.1 x 34 x 59.1 (23.3" x 13.4" x 23.3")
- **Humidity:** 5% - 95% Non-condensing

Dimension

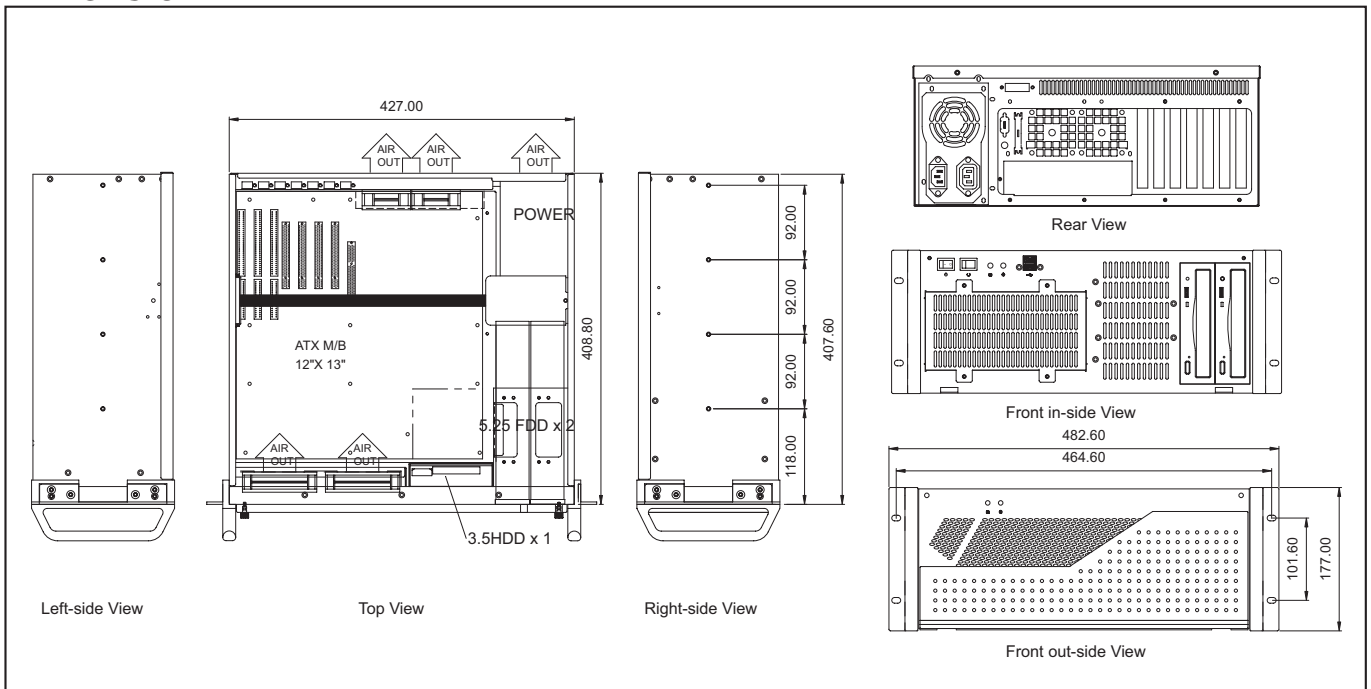

GHI-405

4U Rackmount Chassis



Specifications

- **EIA RS-310C 19" Rackmount Standard**
- **Construction:** Heavy Duty Cold Rolled Electroplated Steel
- **Color:** Black (Standard), Beige or Custom
- **System Boards:** Dual Xeon, Pentium 4, Athlon 64, Dual Opteron
- **Support ATX M/B (Max. to 12" x 10.5")**
- **Drive Capacity:** 1x 5.25" CD-ROM & 2x 3.5" HDD (Hidden)
- **Power Supply (Optional):** PS/2 or Mini Redundant ATX P/S(Rear Installation) Max. Depth 200mm
- **Cooling:** 3x (80mm = 42.5CFM ea.) & 1x (120mm = 90CFM ea.) Fans
- **Connector Port (Front):** 2x USB Ports
- **Air Filter:** Inside Front Panel (Washable)
- **Indicators:** LEDs for Power ON/OFF, HDD Activity
- **Switch:** Power ON/OFF, System Reset
- **Dimensions (W x H x D):** 483 x 177 x 355mm (19" x 7" x 14")
- **Cuft:** 4.0
- **GW:** 12.1 kgs / 26.7 lbs
- **Carton Size(cm):** 60.5 x 34 x 54.5 (23.8" x 13.4" x 21.4")
- **Humidity:** 5% - 95% Non-condensing

Dimension

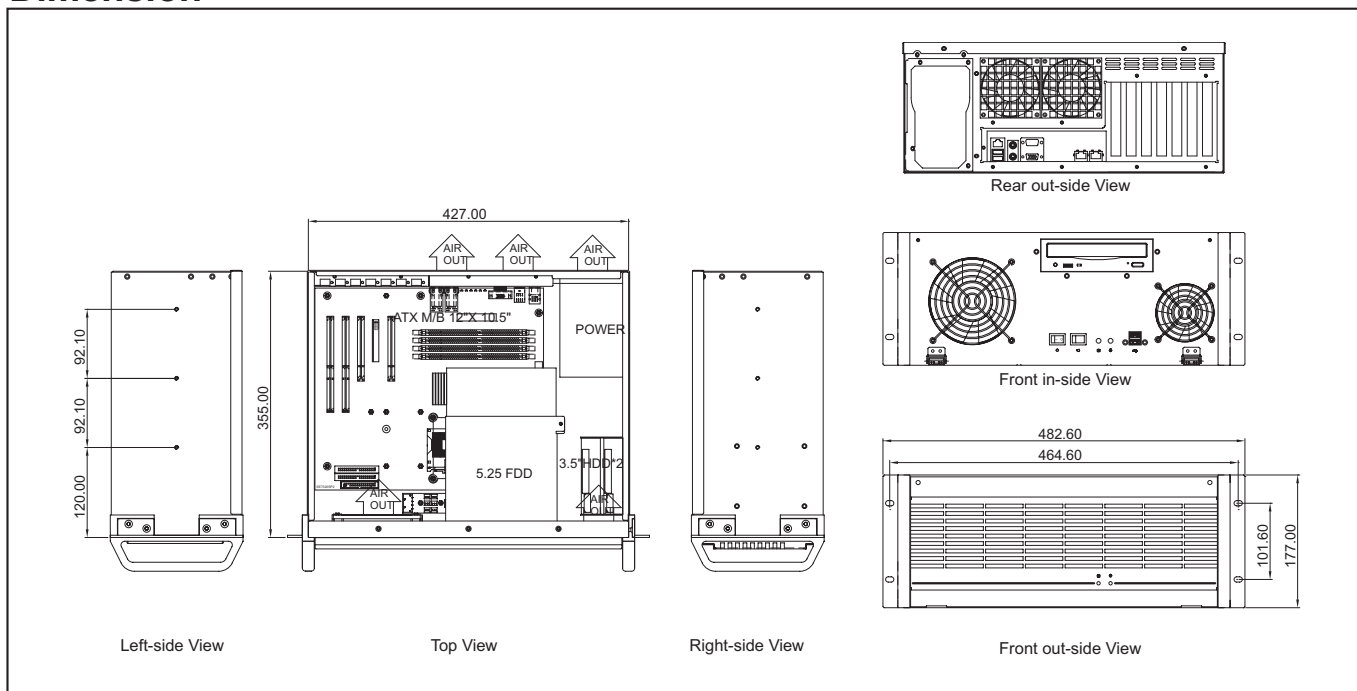

GHI-406ATXR

4U Rackmount Chassis



Specifications

- **EIA RS-310C 19" Rackmount Standard**
- **Construction:** Heavy Duty Cold Rolled Electroplated Steel
- **Color:** Black (Standard), Beige or Custom
- **System Boards:** Dual Xeon, Pentium 4, Athlon 64, Dual Opteron
- **Support Micro ATX (Max. to 9.6" x 9.6")**
- **Drive Capacity:** 2x 5.25" & 4x 2.5"(Hidden)
- **Power Supply (Optional):** PS/2 or Mini Redundant
- **Cooling:** 2x (92mm = 51CFM ea.) & 2x (60mm = 23.5CFM ea.) Fans (Optional)
- **Connector Port (Front):** 2 x USB Ports
- **Front Door:** Single Door with 1 Thumbscrew
- **Air Filter:** Inside Front Panel (Washable)
- **Indicators:** LEDs for Power ON/OFF, HDD Activity
- **Switch:** Power ON/OFF, System Reset
- **Dimensions (W x H x D):** 483 x 177x 302mm (19" x 7" x 11.9")
- **Cuft:** 4.0
- **GW:** 12.1 kgs / 26.7 lbs
- **Carton Size(cm):** 60.5 x 34 x 54.5 (23.8" x 13.4" x 21.4")
- **Humidity:** 5% - 95% Non-condensing

Dimension

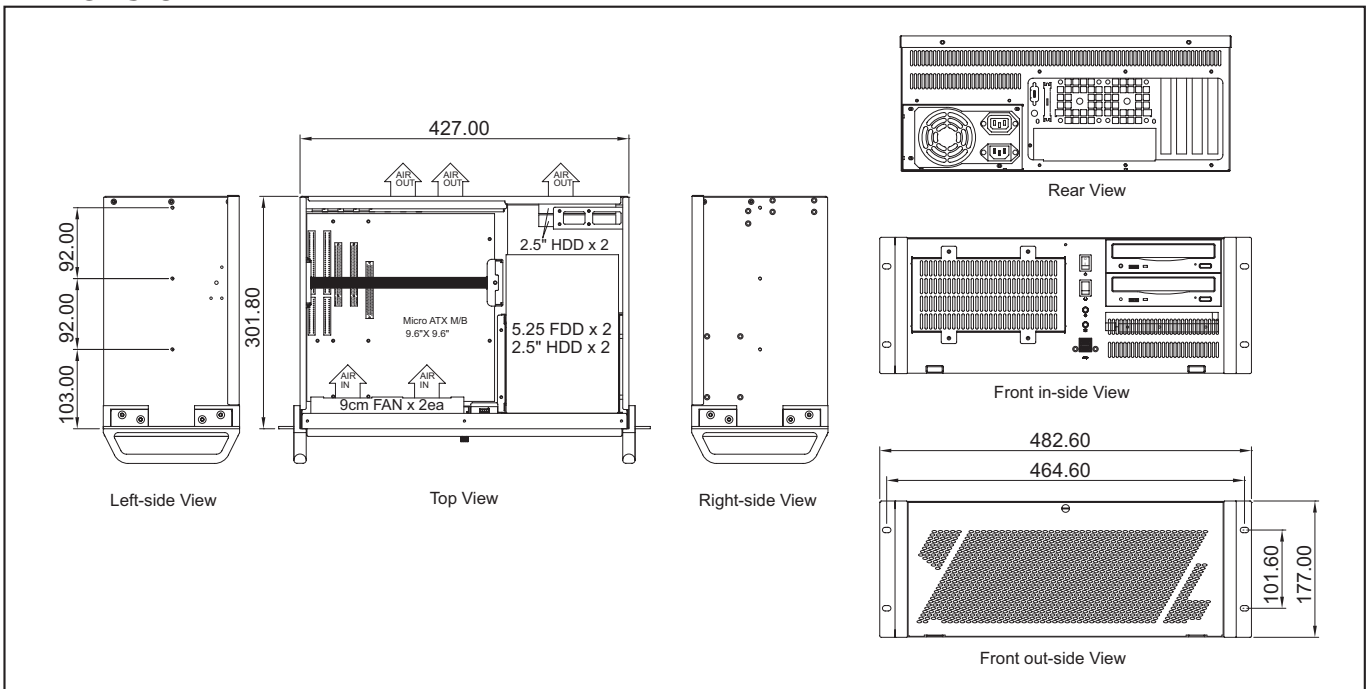

GHI-407

4U Rackmount Chassis



Specifications

- **EIA RS-310C 19" Rackmount Standard**
- **Construction:** Heavy Duty Cold Rolled Electroplated Steel
- **Color:** Black (Standard), Beige or Custom
- **System Boards:** Pentium 4, Dual Xeon, Athlon 64, Dual Opteron
- **Support ATX M/B (Max. to 12" x 9.6") SSI EEB 3.0**
- **Drive Capacity:** 1x 5.25"CD-ROM & 2x 3.5" Hot Swap HDD
- **Power Supply (Optional):** PS/2 Size Single up to 700W or Mini Redundant up to 500W ATX P/S (Rear Installation) Max. Depth 300mm
- **Cooling:** 2x (90mm = 51CFM ea.) Fans & 2x (60mm = 23.5CFM ea.) Fans (Optional)
- **Front Door:** Single Door With 2 Thumbscrews
- **Air Filter:** Inside Front Panel (Washable)
- **Connector Port (Front):** 2x USB Ports
- **Indicators:** LEDs for Power ON/OFF, HDD Activity
- **Flexible Hold Down Bar Designed**
- **Switch:** Power ON/OFF , System Reset
- **Dimensions (W x D x H):** 483 x 177 x 408mm (19" x 7" x 16.1")
- **Cuft:** 4.2
- **GW:** 15.2 kgs / 33.5 lbs
- **Carton Size(cm):** 59.1 x 34 x 59.1 (23.3" x 13.4" x 23.3")
- **Humidity:** 5% - 95% Non-condensing

Dimension

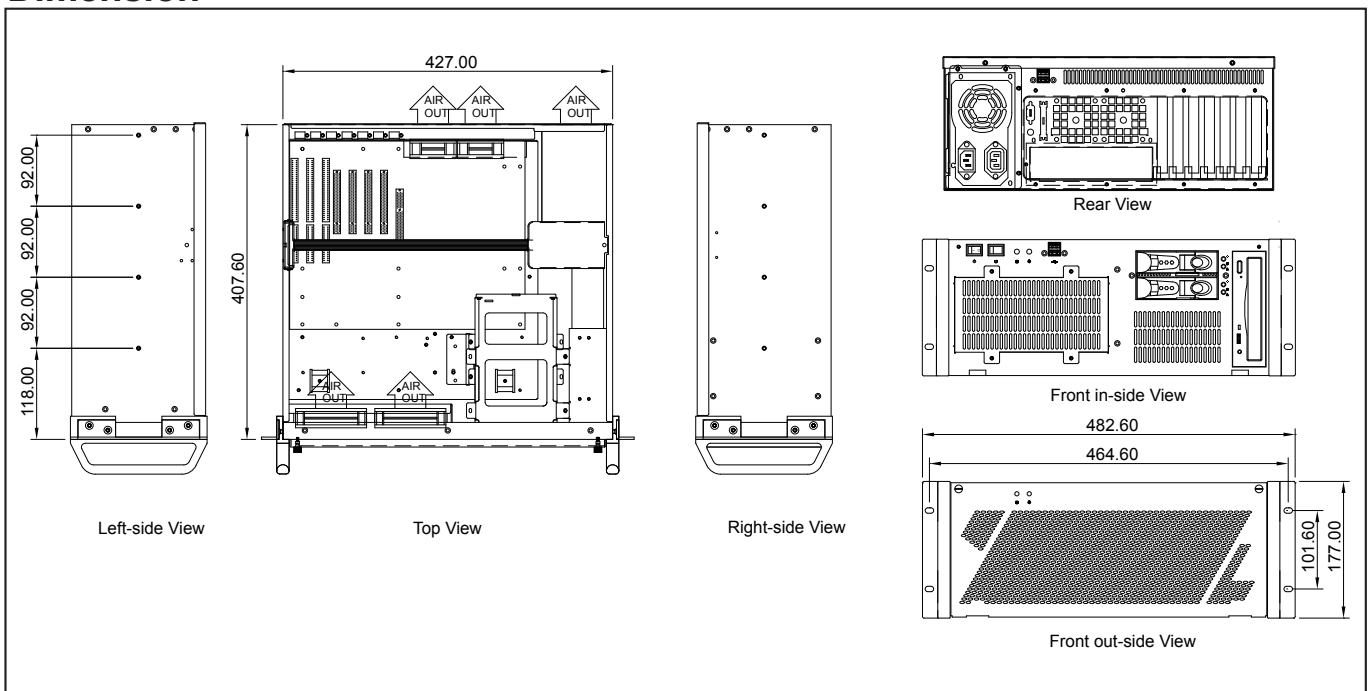

GHI-408ATXR/408SR

4U Rackmount Chassis



Specifications

- **EIA RS-310C 19" Rackmount Standard**
- **Construction:** Heavy Duty Cold Rolled Electroplated Steel
- **IP-Degrees of Protection:** IP 53
- **Color:** Black (Standard), Beige or Custom
- **System Boards:** Pentium 4, Dual Xeon, Athlon 64, Dual Opteron
- **Support ATX M/B (Max. to 12" x 9.6") (408ATXR)**
- **Support 14/15-slot Passive Backplane (408SR)**
- **Drive Capacity:** 3x 5.25" & 1x 3.5"
- **Power Supply (Optional):** PS/2 Size Single up to 700W or Mini Redundant up to 500W ATX P/S(Rear Installation) Max. Depth 200mm
- **Cooling:** 2x (92mm = 51CFM ea.) Hot Swap Fans
- **Front Door:** Drive Panel Door With Keylock
- **Air Filter:** Inside Front Panel (Washable)
- **Connector Dori (Front):** 1x PS/2 for GH-402SR & 2x USB (Optional) Ports
- **Indicators:** LEDs for Power ON/OFF, HDD Activity
- **Switch:** Power ON/OFF, Momentary (Pushbutton), System Reset
- **Flexible Hold Down Bar Designed**
- **Dimensions (W x H x D):** 483 x 177 x 451mm (19" x 7" x 17.8")
- **Cuft:** 4.4
- **GW:** 16.5 kgs / 36.4 lbs
- **Carton Size(cm):** 61.8 x 34 x 59 (24.3" x 13.4" x 23.2")
- **Humidity:** 5% - 95% Non-condensing

Dimension

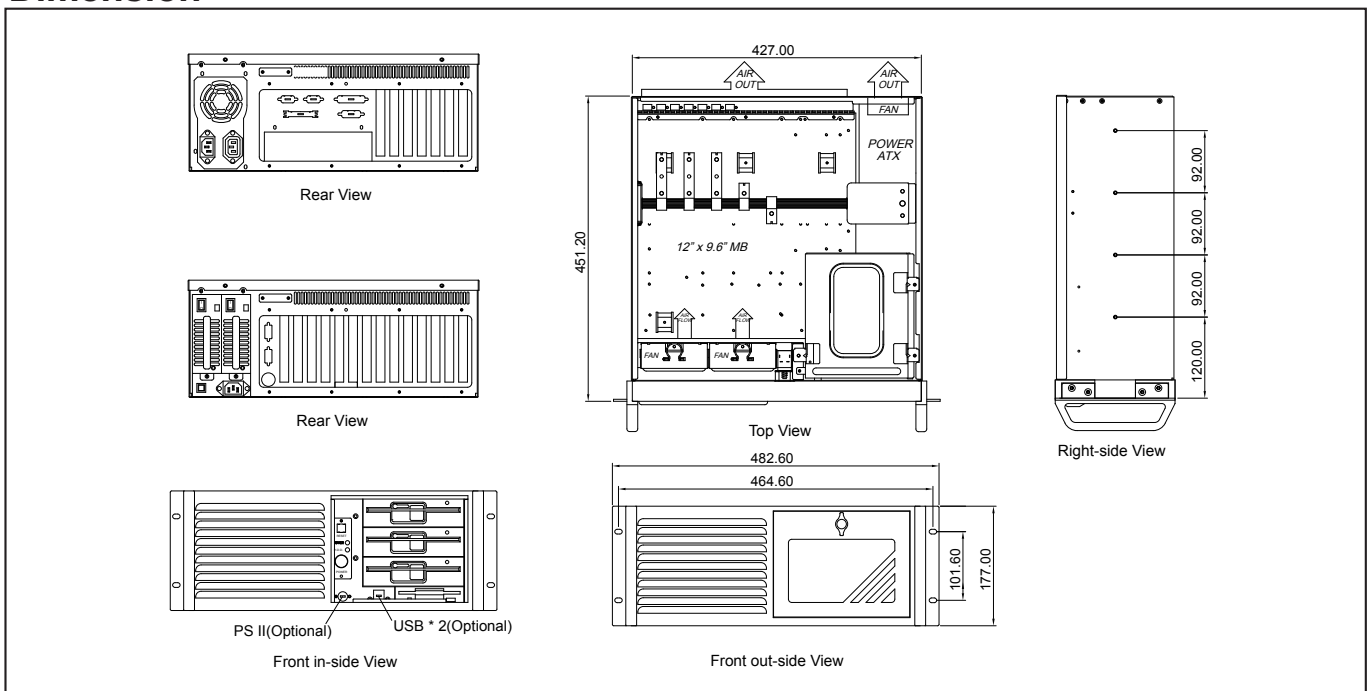

GH-410ATXR/410SR

4U Rackmount Chassis



19" Rackmount

Specifications

- **EIA RS-310C 19" Rackmount Standard**
- **Construction:** Heavy Duty Cold Rolled Electroplated Steel
- **Color:** Black (Standard), Beige or Custom
- **System Boards:** Pentium 4, Dual Xeon, Athlon 64, Dual Opteron
- **Support ATX M/B(Max. to 12" x 9.6")(410ATXR)**
- **Support 14/15-slot Passive Backplane (410SR)**
- **Drive Capacity:** 3x 5.25" & 1x 3.5"HDD & 1x 3.5"HDD (Optional)
- **Power Supply (Optional):** PS/2 Size Single up to 700W or Mini Redundant up to 500W ATX P/S (Rear Installation) Max. Depth 200mm
- **Front Door:** Drive Panel Door With Keylock
- **Connector Port (Front):** 1xPS/2 Port for GH-410SR, 2/1 USB Ports(Optional) on Control Panel
- **Air Filter:** Inside Front Panel (Washable)
- **Cooling:** 1x (120mm = 108CFM ea.) Fan, (One Optional Opening for Extra 120mm Fan)
- **Indicators:** LEDs for Power ON/OFF, HDD Activity
- **Flexible Hold Down Bar Designed**
- **Switch:** Power ON/OFF Momentary (Pushbutton), System Reset
- **Dimensions (WxHxD):** 483 x 177 x 510mm (19" x 7" x 20.1")
- **Cuft:** 4.9
- **GW:** 17.2 kgs / 37.9 lbs
- **Carton Size(cm):** 59.1 x 34 x 68.8 (23.3" x 13.4" x 27.1")
- **Humidity:** 5% - 95% Non-condensing

Dimension

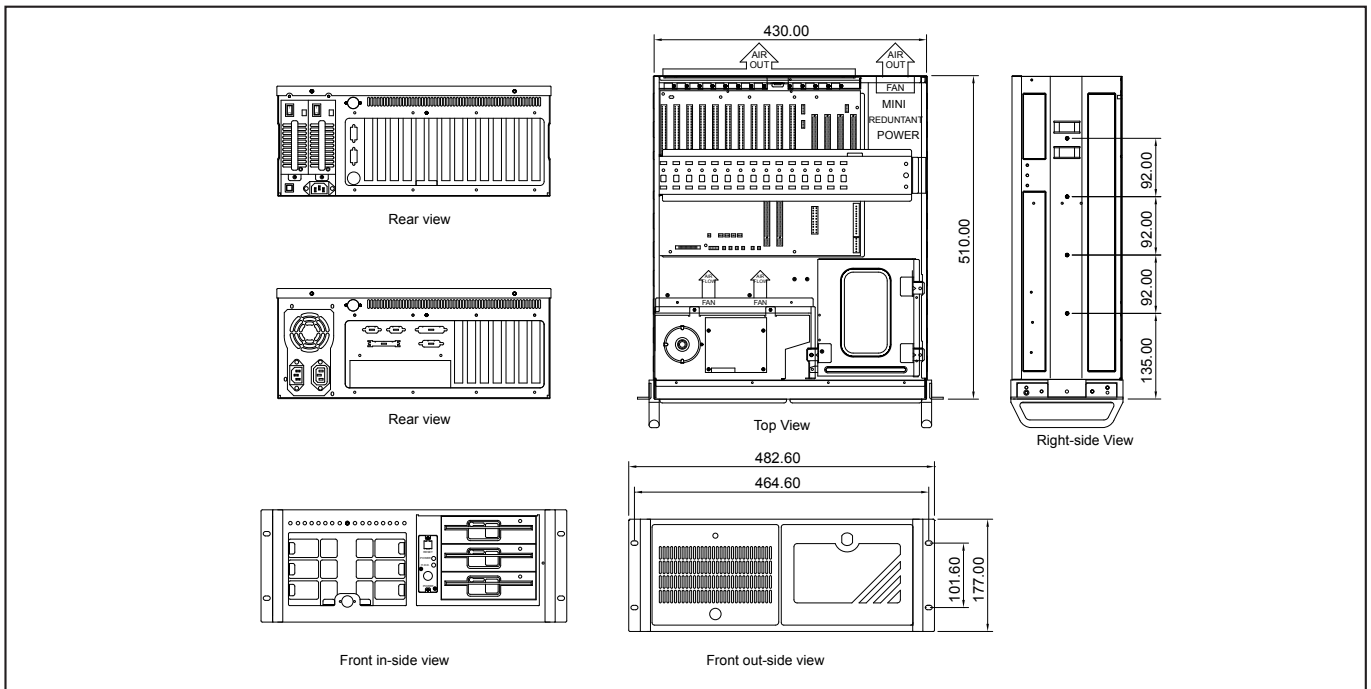

GH-411ATXR/411SR

4U Rackmount Chassis



Specifications

- **EIA RS-310C 19" Rackmount Standard**
- **Construction:** Heavy Duty Cold Rolled Electroplated Steel
- **Color:** Black (Standard), Beige or Custom
- **System Boards:** Pentium 4, Dual Xeon, Athlon 64, Dual Opteron
- **Support ATX M/B (Max. to 12" x 9.6") (411ATXR)**
- **Support 14/15-slot Passive Backplane(411SR)**
- **Drive Capacity:** 4x 5.25" & 1x 3.5"(Vertical) & 1x 3.5"HDD (Optional)
- **Power Supply(Optional):** PS/2 Size Single up to 700W or Mini Redundant up to 500W ATX P/S (Rear Installation) Max. Depth 200mm
- **Connector Port (Front):** 1 x PS/2 Port for GH-411SR & 2 x USB(Optional) Ports
- **Cooling:** 1x (120mm = 108CFM ea.) Fan
- **Front Door:** Single Door with 1 Thumb Twist Keylock
- **Air Filter:** Inside Front Door (Washable)
- **Indicators:** LEDs for Power ON/OFF, HDD Activity
- **Flexible Hold Down Bar Designed**
- **Switch:** Power ON/OFF Momentary (Pushbutton), System Reset
- **Dimensions(WxHxD):** 483 x 177 x 510mm (19" x 7.0" x 20.1")
- **Cuft:** 4.9
- **GW:** 17.4 kgs / 38.4 lbs
- **Carton Size(cm):** 59.1 x 34.0 x 68.8 (23.3" x 13.4" x 27.1")
- **Humidity:** 5% - 95% Non-condensing

Dimension

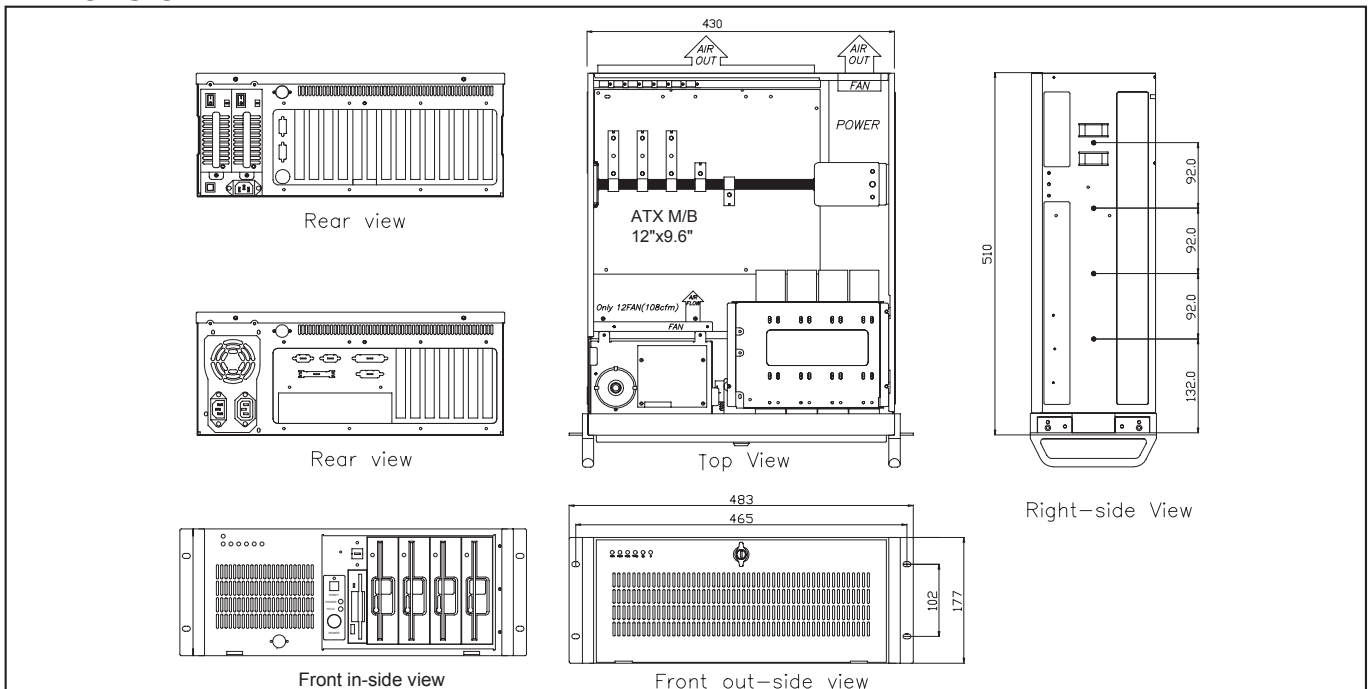

GH-414ATXR/414SR

4U Rackmount Chassis



19" Rackmount

Specifications

- **EIA RS-310C 19" Rackmount Standard**
- **Construction:** Heavy Duty Cold Rolled Electroplated Steel
- **Color:** Black (Standard), Beige or Custom
- **System Boards:** Pentium 4, Dual Xeon, Athlon 64, Dual Opteron
- **Support ATX M/B(Max. to 12"x9.6")(414ATXR)**
- **Support 14/15-slot Passive Backplane(414SR)**
- **Drive Capacity:** 3x5.25" & 1x3.5" & 1x3.5"HDD(Optional)
- **Power Supply(Optional):** PS/2 Size Single up to 700W or Mini Redundant up to 500W ATX P/S (Rear Installation) Max. Depth 220mm
- **Cooling:** 1x (120mm = 108CFM ea.) Fan (One Optional Opening for Extra 120mm Fan)
- **Front Door:** Two Doors With Keylock and Thumbscrew
- **Air Filter:** Inside Front Door (Washable)
- **Connector Port (Front):** 1x PS/2 for GH-414SR & 2x USB (Optional) Ports
- **Indicators:** LEDs for Power ON/OFF, HDD Activity
- **Flexible Hold Down Bar Designed**
- **Switch:** Power ON/OFF Momentary (Pushbutton), System Reset
- **Dimensions(WxHxD):** 483 x 177 x 510mm(19"x7.0"x20.1")
- **Cuft:** 4.9
- **GW:** 17.4 kgs / 38.4 lbs
- **Carton Size(cm):** 59.1 x 34.0 x 68.8 (23.3"x13.4"x27.1")
- **Humidity:** 5% - 95% Non-condensing

Dimension

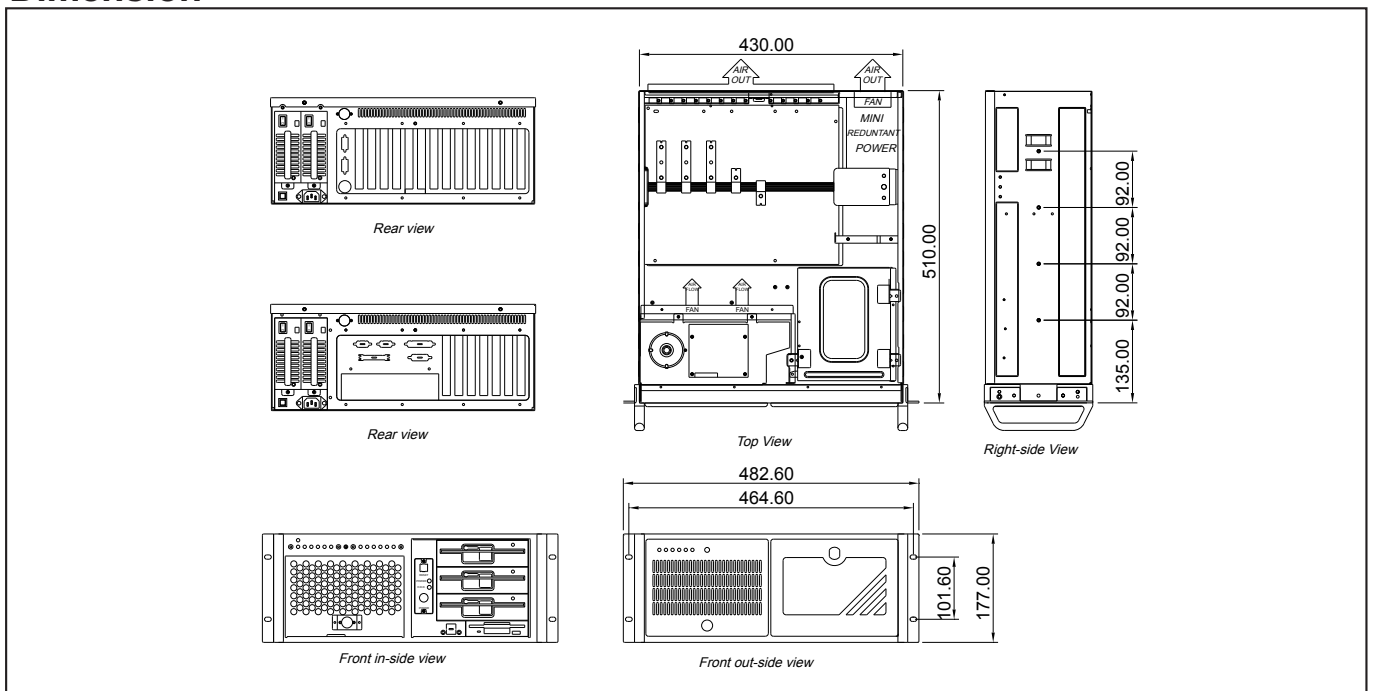

GHI-415ATXR/415SR

4U Rackmount Chassis



Specifications

- **EIA RS-310C 19" Rackmount Standard**
- **Construction:** Heavy Duty Cold Rolled Electroplated Steel
- **Color:** Black (Standard), Beige or Custom
- **System Boards:** Pentium 4, Athlon 64, Dual Xeon, Dual Opteron
- **Support 14/15-Slot Passive Backplane**
- **Drive Capacity:** 1x 5.25" Slim CD-ROM & 1x 3.5" HDD
- **Power Supply (Optional):** PS/2 Size Single up to 700W or Mini Redundant up to 500W ATX P/S (Rear Installation) Max. Depth 220mm
- **Cooling:** 3x (92 mm = 51.0CFM ea.) Fans & 2x(6cm) Fans(23.5CFM ea.)(Optional for ATX M/B)
- **Keyboard:** 83/84 Key With Integrated Track Ball+2 Mouse Buttons
- **Connector Port (Front):** 2x USB Ports
- **Air Filter:** Inside Front Panel (Washable)
- **LCD Size:** 6.4" TFT With 640*480 Resolution, 230cd/m2
- **Display Colors:** 262,144 Colors
- **Indicators:** LEDs for Power ON/OFF, HDD Activity
- **Flexible Hold Down Bar Designed**
- **Switch:** Power ON/OFF, Brightness, Contrast, Menu
- **Dimensions (W x H x D):** 483 x 177 x 490mm (19.0" x 7.0" x 19.3")
- **Cuft:** 4.7
- **GW:** 20.0 kgs / 44.1 lbs
- **Carton Size(cm):** 59.1 x 34.0 x 66.8 (23.3" x 13.4" x 26.3")
- **Humidity:** 5% - 95% Non-condensing

Dimension

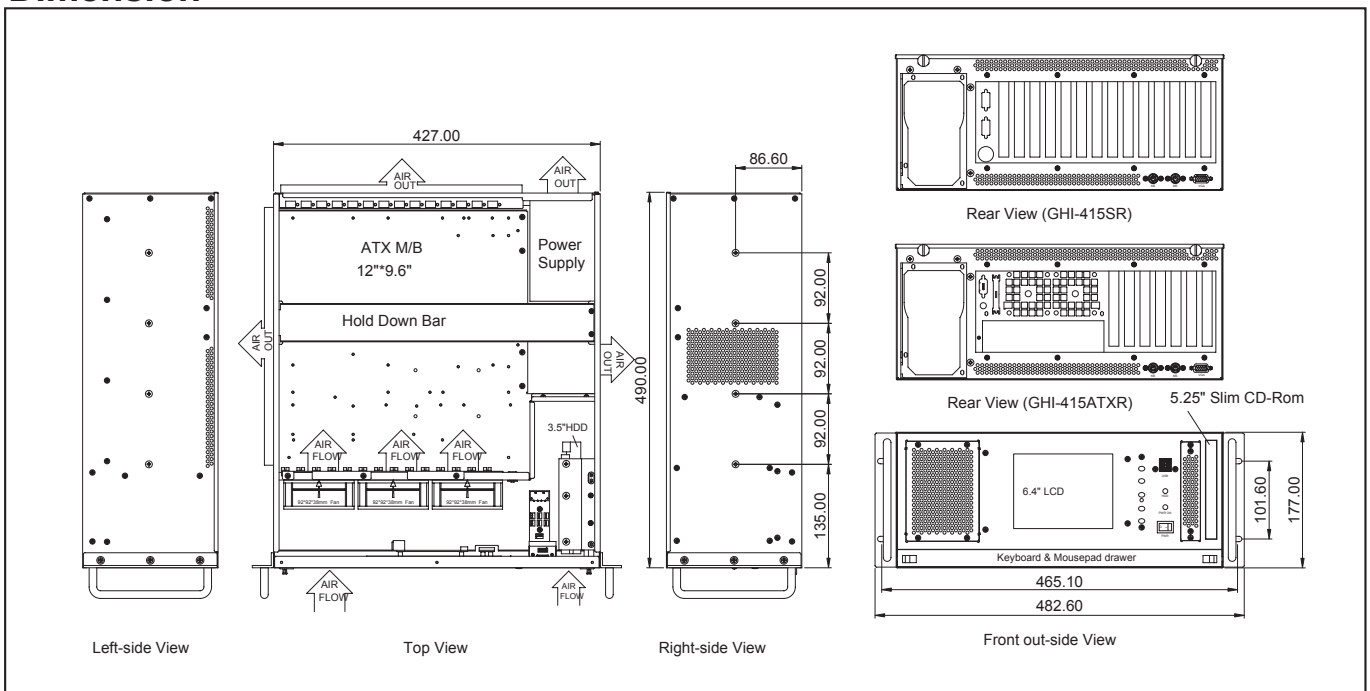

GH-416ATXR/416SR

4U Rackmount Chassis



19" Rackmount

Specifications

- **EIA RS-310C 19" Rackmount Standard**
- **Construction:** Heavy Duty Cold Rolled Electroplated Steel
- **Color:** Black (Standard), Beige or Custom
- **System Boards:** Pentium 4, Dual Xeon, Athlon 64, Dual Opteron
- **Support ATX M/B (Max. to 12" x 9.6") (416ATXR)**
- **Support 14/15-slot Passive Backplane (416SR)**
- **Drive Capacity:** 3x 5.25" & 1x 3.5" & 1x 3.5"HDD (Optional)
- **Power Supply (Optional):** PS/2 Size Single up to 700W or Mini Redundant up to 500W ATX P/S (Rear Installation) Max. Depth 220mm
- **Connector Port (Front):** 1x PS/2 for GH-416SR & 2x USB (Optional) Ports
- **Cooling:** 1x (120mm = 108CFM ea.) Fans, (One Optional Opening for Extra 120mm Fan)
- **Front Door:** Single Door with 1 Thumb Twist Keylock
- **Indicators:** LEDs for Power ON/OFF, HDD Activity
- **Flexible Hold Down Bar Designed**
- **Switch:** Power ON/OFF Momentary (Pushbutton), SystemReset
- **Dimensions(WxHxD):** 483 x 177 x 510mm (19" x 7.0" x 20.1")
- **Cuft:** 4.9
- **GW:** 17.2 kgs / 37.9 lbs
- **Carton Size(cm):** 59.1x34.0x68.8 (23.3" x 13.4" x 27.1")
- **Humidity:** 5% - 95% Non-condensing

Dimension

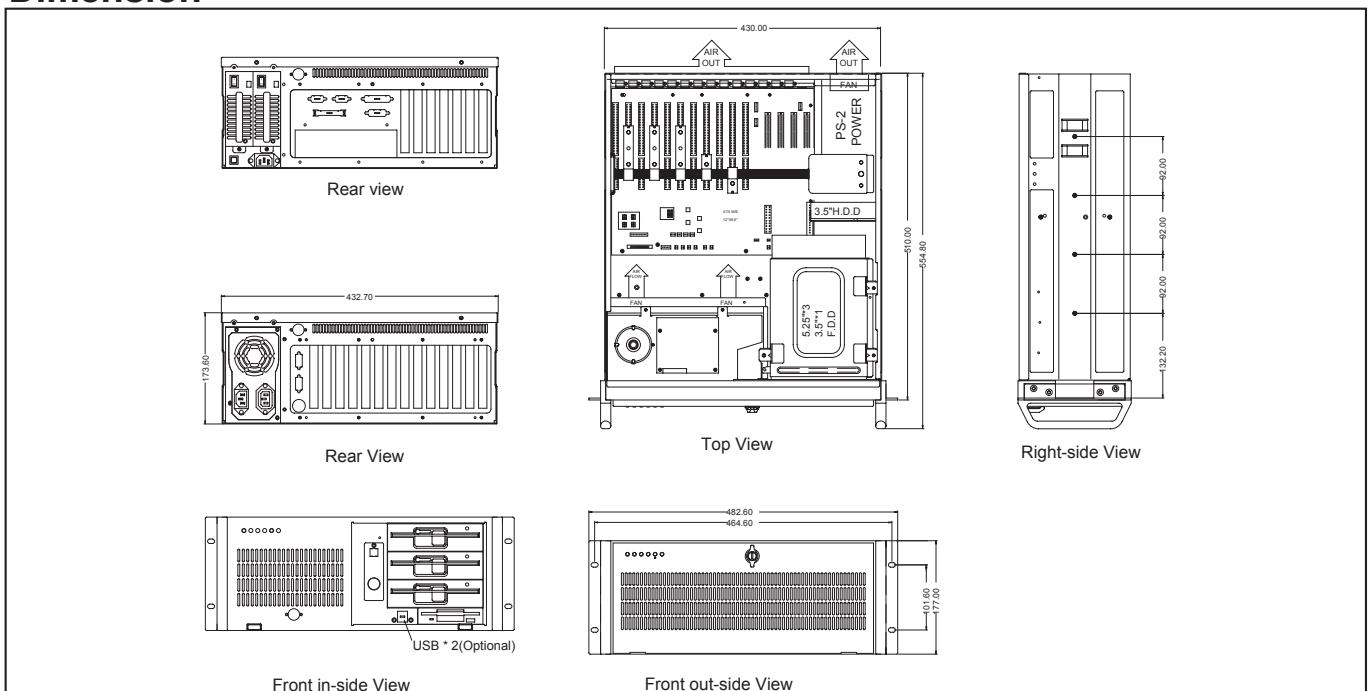

GH-418ATXR/418SR

4U Rackmount Chassis

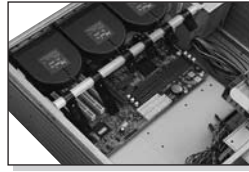

Specifications

- **EIA RS-310C 19" Rackmount Standard**
- **Construction:** Heavy Duty Cold Rolled Electroplated Steel
- **Color:** Black (Standard), Beige or Custom
- **System Boards:** Pentium 4, Dual Xeon, Athlon 64, Dual Opteron
- **Support ATX M/B (Max. to 12" x 9.6") (418ATXR)**
- **Support 14/15-slot Passive Backplane (418SR)**
- **Drive Capacity:** 3x 5.25" & 1x 3.5" & 2x 3.5" HDD
- **Power Supply (Optional):** PS/2 Size Single up to 700W or Mini Redundant up to 500W ATX P/S (Rear Installation) Max. Depth 220mm
- **Cooling:** 1x (120mm = 90CFM ea.) Fan & 3x (90mm = 32 CFM ea.) Optional Blower (GHA-F418)
- **Front Door:** Drive Panel Door With Keylock
- **Air Filter:** Inside Front Door (Washable)
- **Indicators:** LEDs for Power, HDD Activity
- **Flexible Hold Down Bar Designed**
- **Switch:** Power ON/OFF/ON/OFF Momentary (Pushbutton), System Reset
- **Dimensions(WxHxD):** 483 x 177 x 510mm (19" x 7.0" x 20.1")
- **Cuft:** 3.8
- **GW:** 14.4 kgs / 37.1 lbs
- **Carton Size(cm):** 57.5 x 31.5 x 70 (22.6" x 12.4" x 27.6")
- **Humidity:** 5% - 95% Non-condensing

Dimension

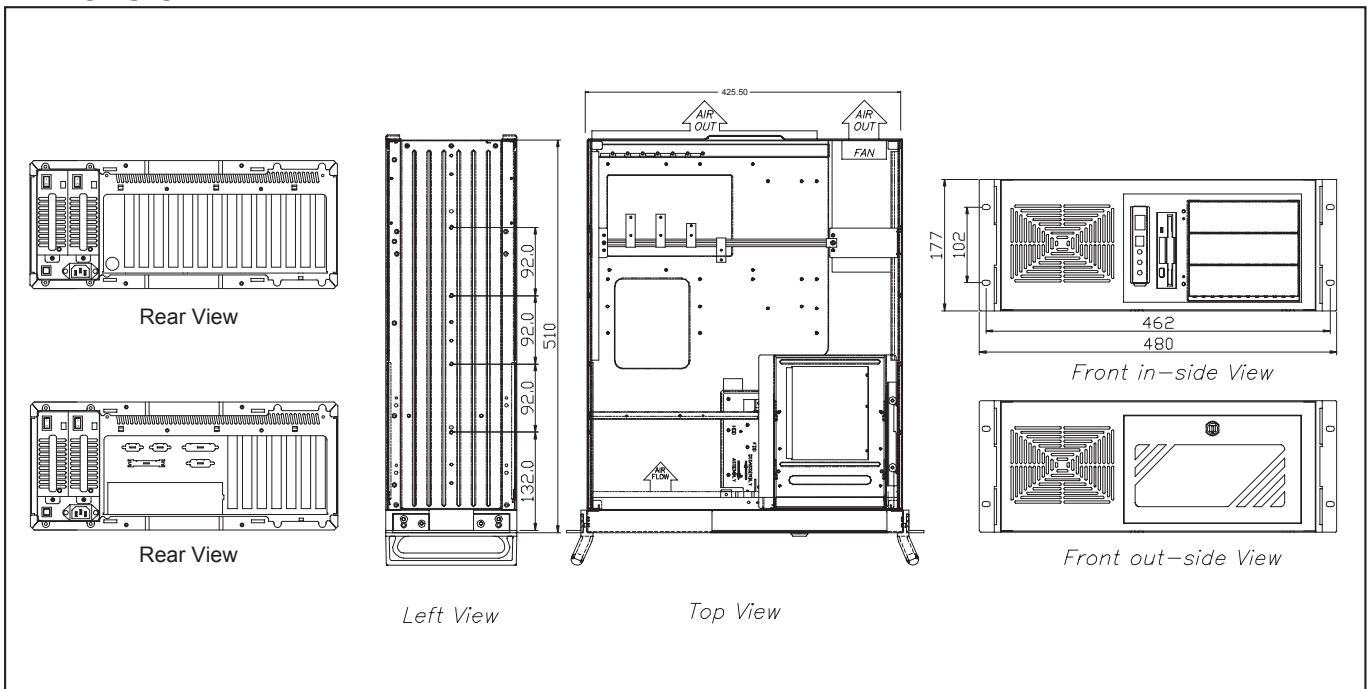

GHI-419ATXR/419SR

4U Rackmount Chassis



19" Rackmount

Specifications

- **EIA RS-310C 19" Rackmount Standard**
- **Construction:** Heavy Duty Cold Rolled Electroplated Steel
- **Color:** Black (Standard), Beige or Custom
- **System Boards:** Pentium 4, Dual Xeon, Athlon 64, Dual Opteron
- **Support EATX M/B (Max. to 12" x 13") SSI EEB 3.0**
- **Support 14/15-slot Passive Backplane (GHI-419SR)**
- **Drive Capacity:** 2x 5.25" & 1x 3.5" & 5x 3.5" HDD & 1x 3.5"HDD (Optional)
- **Power Supply (Optional):** PS/2 Size Single up to 700W or Redundant up to 500W ATX P/S(Rear Installation)Max. Depth 300mm
- **Cooling:** 2x (90mm = 51CFM ea.) Fans & 2x (60mm = 23.5CFM ea.) Fans (Optional)
- **Connector Port (Front):** 1x PS/2 for GH-419SR & 2x USB (Optional) Ports
- **Front Door:** Two Doors with Keylock and Thumbscrew
- **Air Filter:** Inside Front Door (Washable)
- **Indicators:** LEDs for Power ON/OFF, HDD Activity
- **Flexible Hold Down Bar Designed**
- **Switch:** Power ON/OFF Momentary (Pushbutton), System Reset
- **Dimensions(WxHxD):** 483 x 177 x 510mm (19" x 7.0" x 20.1")
- **Cuft:** 4.9
- **GW:** 17.8kgs / 39.3lbs
- **Carton Size(cm):** 68.8 x 34.0 x 59.1 (27.1" x 13.4" x 23.3")
- **Humidity:** 5% - 95% Non-condensing

Dimension

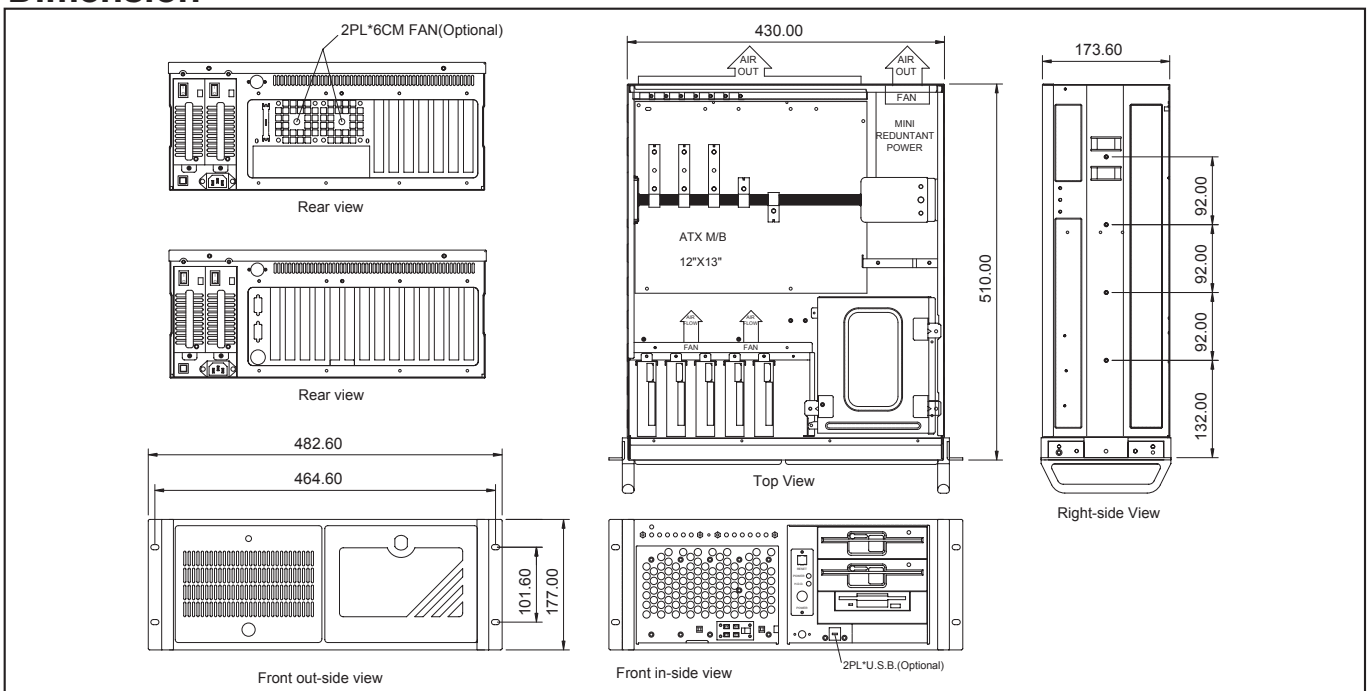

GH-430ATXR/430SR

4U Rackmount Chassis



Specifications

- **EIA RS-310C 19" Rackmount Standard**
- **Construction:** Heavy Duty Cold Rolled Electroplated Steel
- **Color:** Black (Standard), Beige or Custom
- **System Boards:** Pentium 4, Dual Xeon, Athlon 64, Dual Opteron
- **Support EATX M/B (Max. to 12" x 13") (430ATXR)**
- **Support 19-slot Passive Backplane (430SR)**
- **Drive Capacity:** 3x 5.25" & 1x 3.5" & 2x 3.5"HDD (Optional)
- **Power Supply (Optional):** GH-430ATXR: PS/2 Size Single up to 700W or Mini Redundant up to 500W ATX P/S (Rear Installation) Max. Depth 200mm
GH-430SR: Vertical Full Size Redundant P/S up to 460W ATX P/S (Front Installation) Max. Depth 200mm
- **Cooling:** Hot Swappable 4x (92mm = 51CFM ea.) Fans & 1x (80mm = 42.5CFM ea.) Fans (430ATXR-Optional)
- **Front Door:** Single Door With 1 Thumb Twist Keylock
- **Connector Port (Front):** 2x USB Ports (Optional)
- **Air Filter:** Inside Front Door (Washable)
- **Thermal Management Card:** GHA-CO03 (Optional)
- **Indicators:** LEDs for Power ON/OFF, HDD Activity
- **Flexible Hold Down Bar Designed**
- **Switch:** Power ON/OFF Momentary (Pushbutton), System Reset
- **Dimensions (W x H x D):** 483 x 177 x 671mm (19" x 7.0" x 26.4")
- **Cuft:** 5.8
- **GW:** 21.0 kgs / 46.3 lbs
- **Carton Size(cm):** 85.4 x 33.6 x 57.6 (33.6" x 13.2" x 22.7")
- **Humidity:** 5% - 95% Non-condensing

Dimension

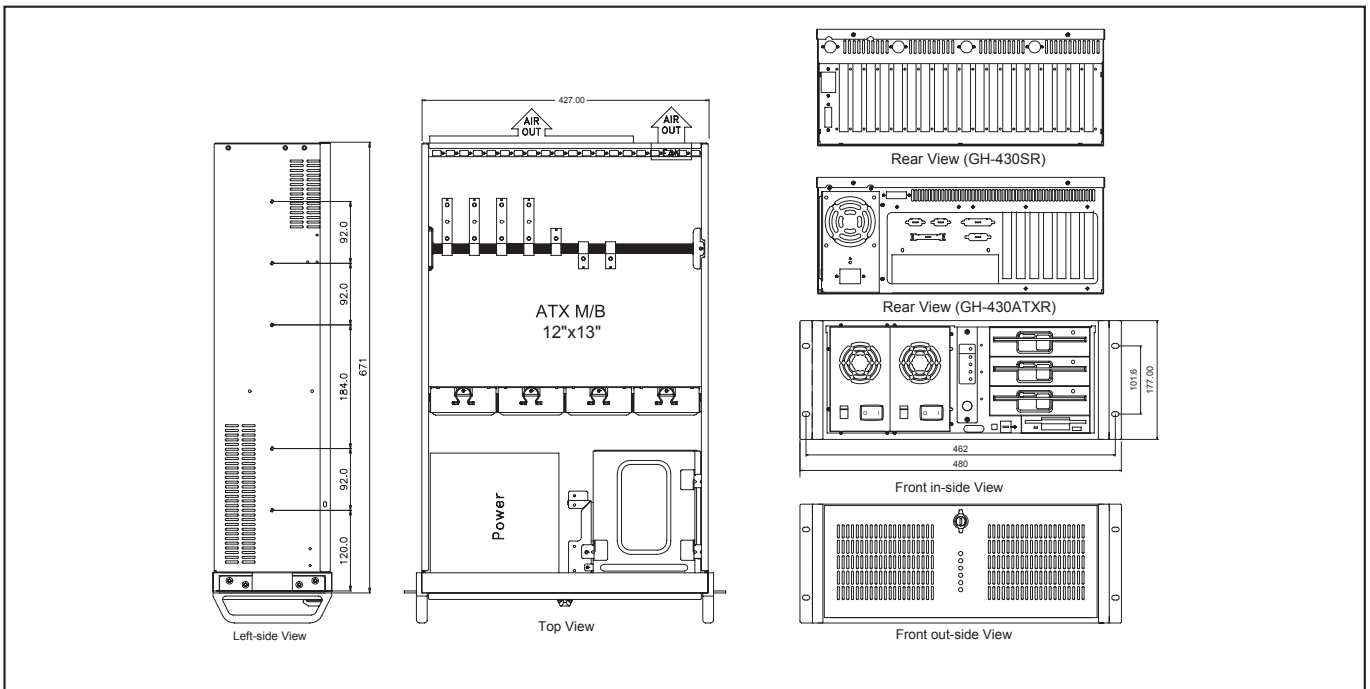

GH-432ATXR/432SR

4U Rackmount Chassis



Specifications

- **EIA RS-310C 19" Rackmount Standard**
- **Construction:** Heavy Duty Cold Rolled Electroplated Steel
- **Color:** Black (Standard), Beige or Custom
- **System Boards:** Dual Xeon, Pentium 4, Dual Pentium III
- **Support EATX M/B(Max. to 12"x13")(432ATXR)**
- **Support 19-slot Passive Backplane(432SR)**
- **Drive Capacity:** 3x 5.25" & 1x 3.5" & 2x 3.5"HDD & 2x 3.5"HDD (Optional)
- **Power Supply(Optional):** PS/2 Size Single up to 700W or Mni Redundant up to 500W ATX P/S (Front Installation) Max. Depth 200mm
- **Cooling:** Hot Swappable 4x (92mm = 51CFM ea.) Fans & 1x (80mm = 42.5CFM ea.) Fans (432ATXR-Optional)
- **Front Door:** Single Door with 1 Thumb Twist Keylock
- **Connector Port (Front):** 2x USB Ports (Optional)
- **Air Filter:** Inside Front Door (Washable)
- **Thermal Management Card:** GHA-CO03 (Optional)
- **Indicators:** LEDs for Power ON/OFF, HDD Activity
- **Flexible Hold Down Bar Designed**
- **Switch:** Power ON/OFF Momentary (Pushbutton), System Reset
- **Dimensions (WxHxD):** 483x177x671mm (19" x 7.0" x 26.4")
- **Cuft:** 5.8
- **GW:** 21.0kgs / 46.3lbs
- **Carton Size(cm):** 85.4 x 33.6 x 57.6 (33.6" x 13.2" x 22.7")
- **Humidity:** 5% - 95% Non-condensing

Dimension

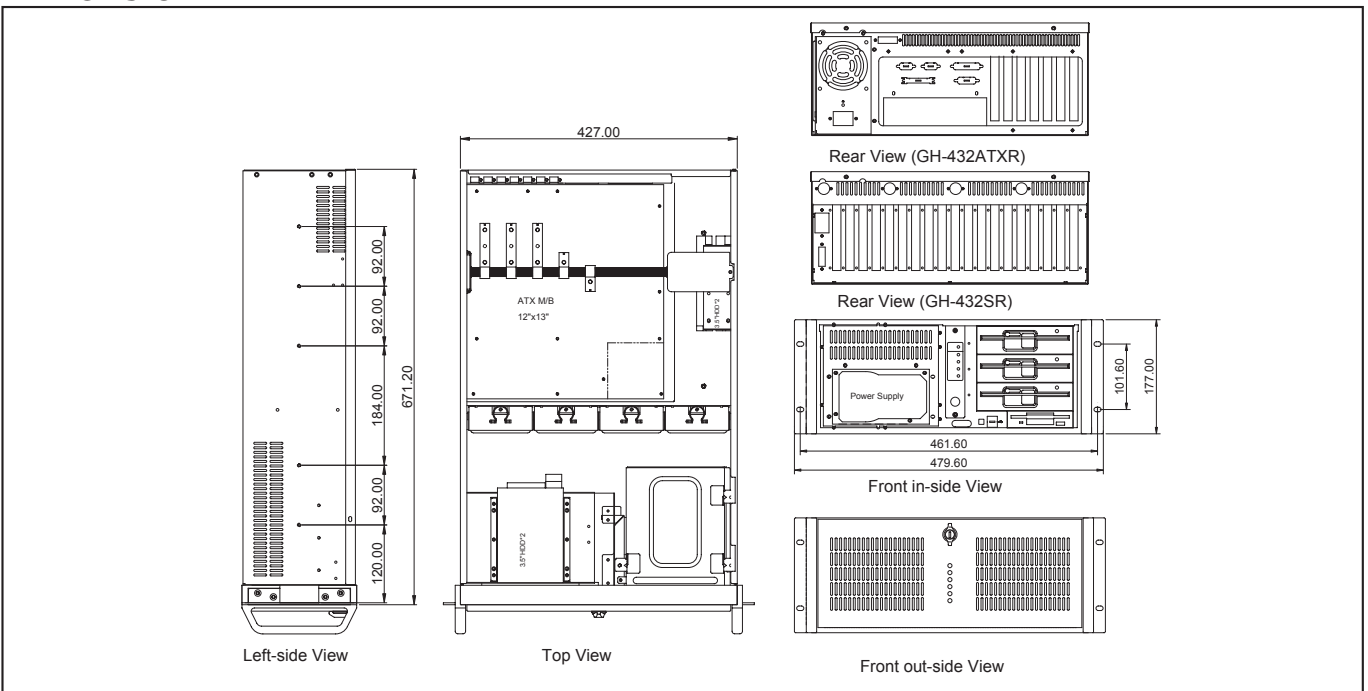

GHI-433

4U Rackmount Chassis



Specifications

- **EIA RS-310C 19" Rackmount Standard**
- **Construction:** Heavy Duty Cold Rolled Electroplated Steel
- **Color:** Black (Standard), Beige or Custom
- **System Boards:** Pentium 4, Dual Xeon, Athlon 64, Dual Opteron
- **Supports EATX M/B (Max. to 12" x 10.5") SSI EEB 3.0**
- **Drive Capacity:** 6x CD-ROM & 1x 3.5"HDD & 1x 3.5"FDD
- **Power Supply (Optional):** Single PS2 up to 700W or Mini Redundant up to 500W ATX P/S (Rear Installation) Max. Depth 200mm
- **Cooling:** 3x (120mm = 90CFM ea.) Fans
- **Front Door:** Two Doors With Keylock
- **Flexible Hold Down Bar Designed**
- **Connector Port (Front):** 2x USB
- **Indicators:** LEDs for Power ON/OFF, HDD Activity, LAN
- **Switch:** Power ON/OFF (Momentary), System Reset
- **Dimensions (W x H x D):** 483 x 177 x 573mm (19.0" x 7.0" x 22.6")
- **Cuft:** 5.2
- **GW:** 19.8 kgs / 43.7 lbs
- **Carton Size (cm):** 75.0 x 33.1 x 59.0 (29.5" x 13.0" x 23.2")
- **Humidity:** 5% - 95% Non-condensing

Dimension

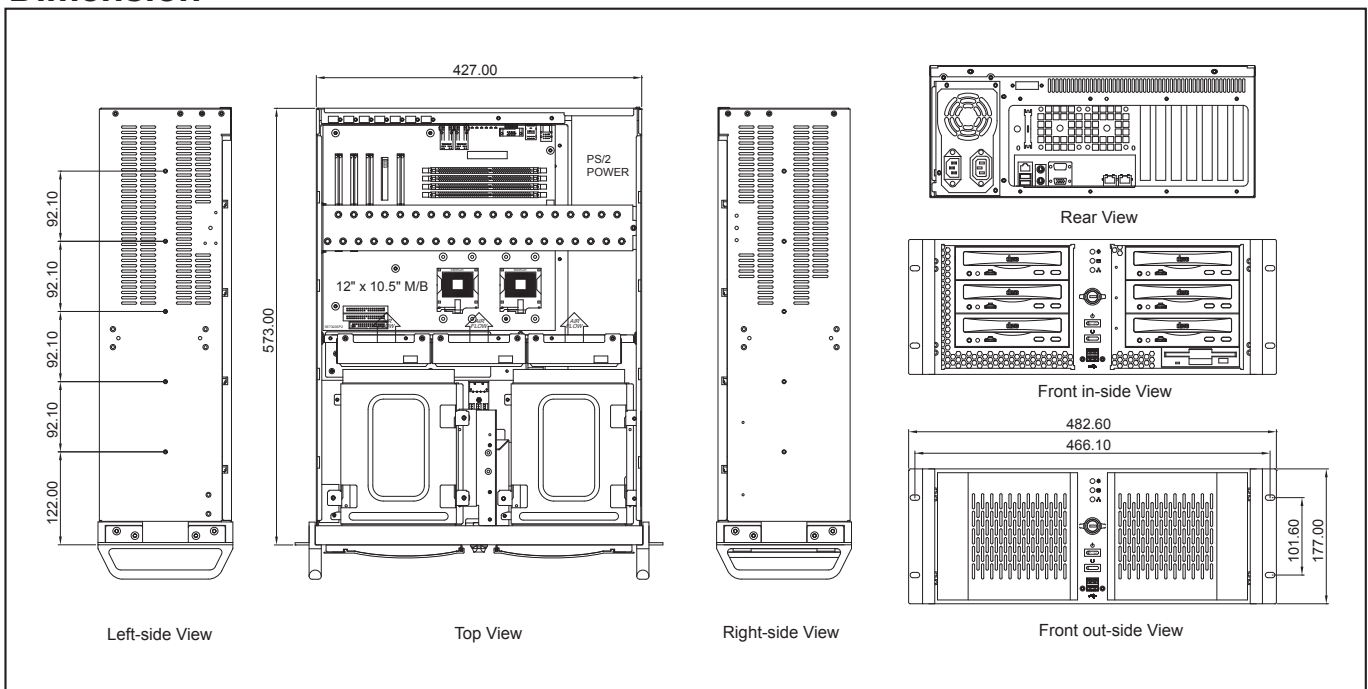

GHI-440

4U Rackmount Chassis

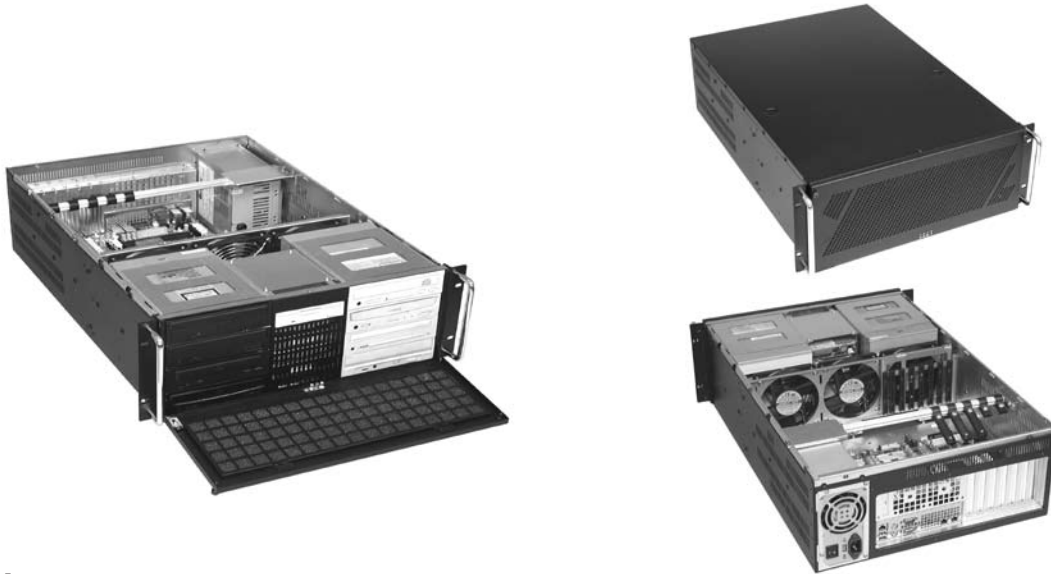

Specifications

- **EIA RS-310C 19" Rackmount Standard**
- **Construction:** Heavy Duty Cold Rolled Electroplated Steel
- **Color:** Black (Standard), Beige or Custom
- **System Boards:** Pentium 4, Dual Xeon, Athlon 64, Dual Opteron
- **Supports EATX M/B (Max. to 12" x 13") SSI EEB 3.0**
- **Drive Capacity:** 8x CD-ROM & 4x 3.5"HDD & 1x 3.5"FDD or 1x CD-ROM & 15x 3.5"HDD & 1x 3.5"FDD
- **Power Supply (Optional):** PS2 Size Single up to 700W or Mini Redundant up to 500W ATX P/S (Rear Installation) Max. Depth 300mm
- **Cooling:** 3x (120mm = 90CFM ea.) Fans & 2x (60mm = 23.5CFM ea.)(Optional) Fans
- **Front Door:** Single Door with 2 Thumbscrews (Removable)
- **Connector Port (Front):** 2x USB Ports
- **Indicators:** LEDs for Power ON/OFF, HDD Activity, 2x LAN
- **Flexible Hold Down Bar Designed**
- **Switch:** Power ON/OFF Momentary (Dimple), System Reset
- **Dimensions(WxHxD):** 483x177x624mm(19" x 7.0" x 24.5")
- **Cuft:** 5.5
- **GW:** 19.5 kgs / 43.0 lbs
- **Carton Size (cm):** 80.0 x 33.1 x 59.0(31.5" x 13.0" x 23.2")
- **Humidity:** 5% - 95% Non-condensing

Dimension

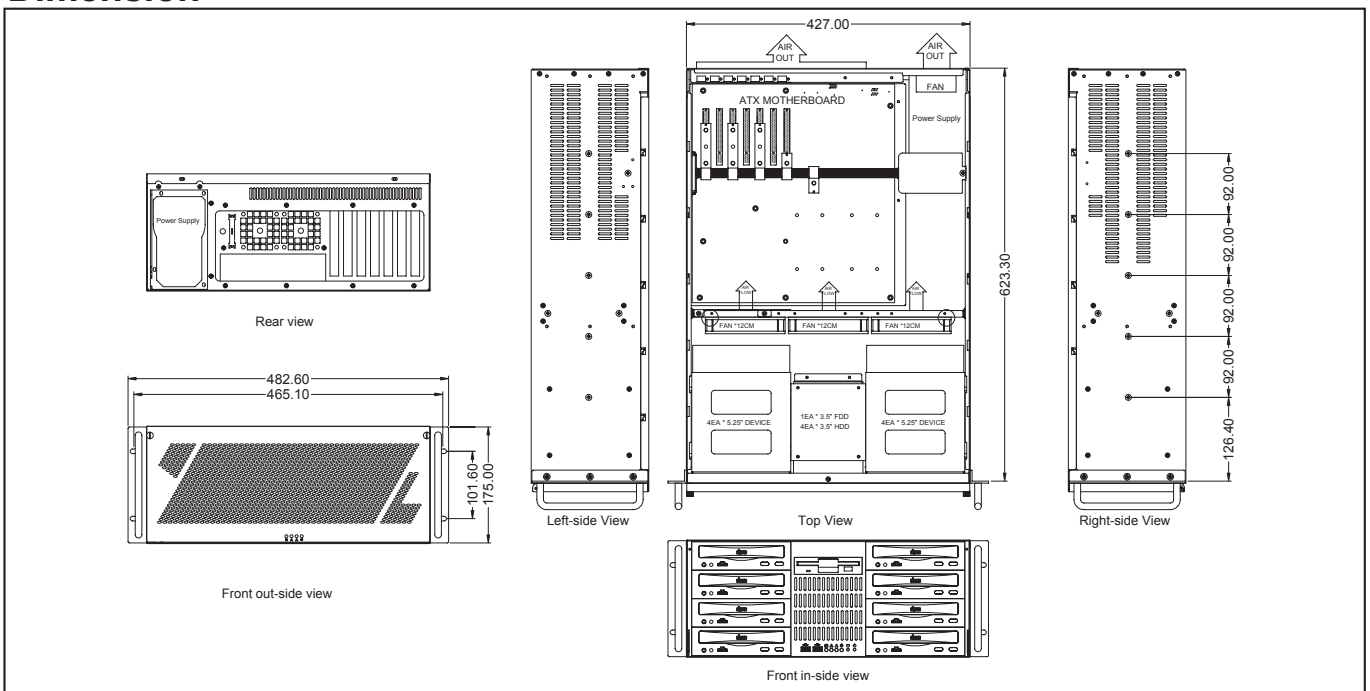

GHI-441

4U Rackmount Chassis



19" Rackmount

Specifications

- **EIA RS-310C 19" Rackmount Standard**
- **Construction:** Heavy Duty Cold Rolled Electroplated Steel
- **Color:** Black (Standard), Beige or Custom
- **System Boards:** Pentium 4, Dual Xeon, Athlon 64, Dual Opteron
- **Supports EATX M/B (Max. to 12" x 10.5") SSI EEB 3.0**
- **With Removable Drawer**
- **Drive Capacity:** 8x CD-ROM & 4x 3.5"HDD & 1x 3.5"FDD or 1x CD-ROM & 15x 3.5"HDD & 1x 3.5"FDD
- **Power Supply (Optional):** PS2 Size Single up to 700W or Mini Redundant up to 500W ATX P/S (Rear Installation) Max. Depth 250mm
- **Cooling:** 3x (120mm = 90CFM ea.) Fans & 2x (60mm = 23.5CFM ea.) Fans (Optional)
- **Front Door:** Single Door with 2 Thumbscrews (Removable)
- **Connector Port (Front):** 2x USB Ports
- **Indicators:** LEDs for Power ON/OFF, HDD Activity, 2x LAN
- **Flexible Hold Down Bar Designed**
- **Switch:** Power ON/OFF Momentary (Dimple), System Reset
- **Dimensions (WxHxD):** 483 x 177 x 571mm (19" x 7.0" x 22.5")
- **Cuft:** 5.2
- **GW:** 20.2 kgs / 44.5 lbs
- **Carton Size (cm):** 75 x 33.1 x 59.0 (29.5" x 13" x 23.2")
- **Humidity:** 5% - 95% Non-condensing

Dimension

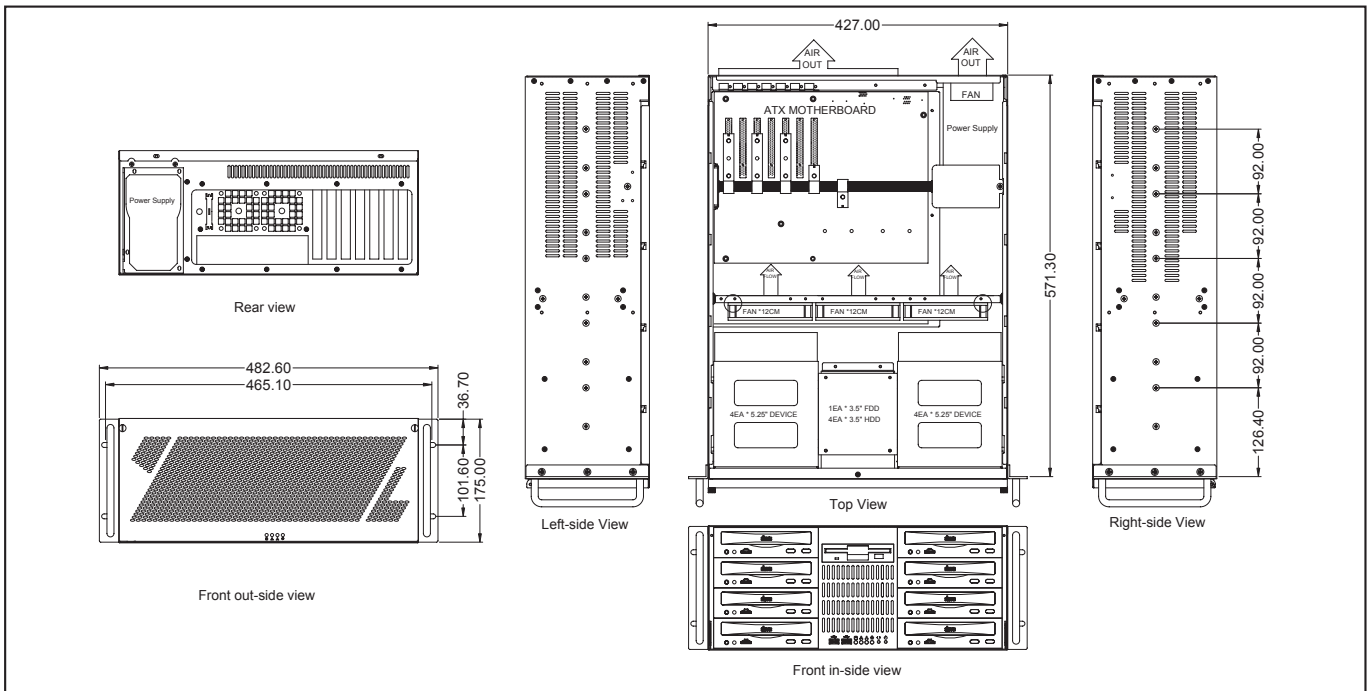

GHI-442

4U Rackmount Chassis



Specifications

- **EIA RS-310C 19" Rackmount Standard**
- **Construction:** Heavy Duty Cold Rolled Electroplated Steel
- **Color:** Black (Standard), Beige or Custom
- **System Boards:** Pentium 4, Dual Xeon, Athlon 64, Dual Opteron
- **Supports EATX M/B (Max. to 12" x 13") SSI EEB 3.0**
- **Drive Capacity:** 10x CD-ROM or 12x 3.5"HDD & 2x CD-ROM
- **Power Supply (Optional):** PS2 Size Single up to 700W or Mini Redundant up to 500W ATX P/S (Rear Installation) Max. Depth 300mm
- **Cooling:** 3x (120mm = 90CFM ea.) Fans & 2x (60mm = 23.5CFM ea.) Fans (Optional)
- **Front Door:** Single Door with 2 Thumbscrews (Removable)
- **Air Filter:** Inside Front Door (Washable)
- **Connector Port (Front):** 2x USB Ports
- **Indicators:** LEDs for Power ON/OFF, HDD Activity, 2x LAN
- **Flexible Hold Down Bar Designed**
- **Switch:** Power ON/OFF Momentary (Dimple), System Reset
- **Dimensions (WxHxD):** 483 x 177 x 624mm (19" x 7.0" x 24.5")
- **Cuft:** 5.7
- **GW:** 19.1 kgs / 42.1 lbs
- **Carton Size (cm):** 85.5x34.0x56.5 (33.7" x 13.4" x 22.2")
- **Humidity:** 5% - 95% Non-condensing

Dimension

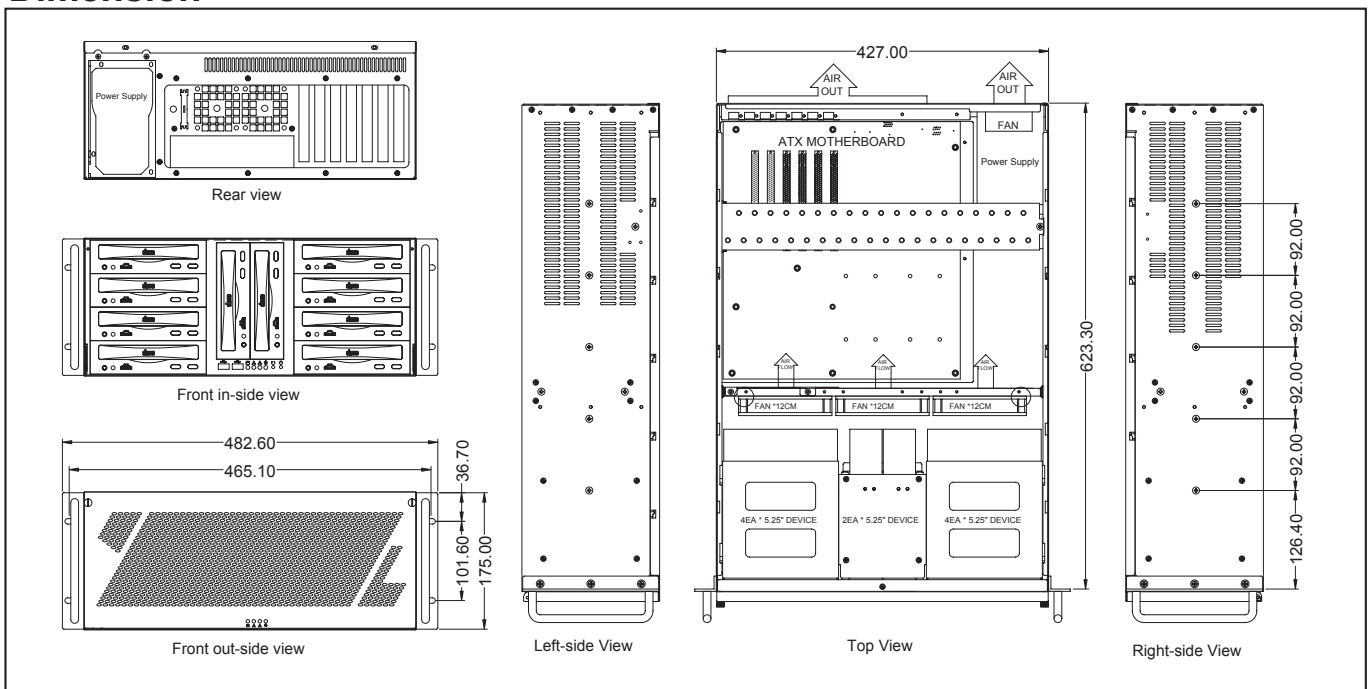

GHI-443

4U Rackmount Chassis



19" Rackmount

Specifications

- **EIA RS-310C 19" Rackmount Standard**
- **Construction:** Heavy Duty Cold Rolled Electroplated Steel
- **Color:** Black (Standard), Beige or Custom
- **System Boards:** Pentium 4, Dual Xeon, Athlon 64, Dual Opteron, Quad Opteron
- **Supports EATX M/B (Max. to 12" x 13") SSI EEB 3.0**
- **Drive Capacity:** 3x CD-ROM & 10x 3.5" Swappable Trays
- **Power Supply(Optional) :** PS/2 Size Single up to 700W or Mini Redundant up to 500W ATX P/S (Rear Installation) Max. Depth 300mm
- **Cooling:** 3x (120mm = 90CFM ea.) Fans & 2x (60mm = 23.5CFM ea.)(Optional) Fans
- **Front Door:** Single Door With 2 Thumbscrews
- **Connector Port (Front):** 2x USB Ports
- **Indicators:** LEDs for Power ON/OFF, HDD Power/Access/ Fault, 2x LAN
- **Flexible Hold Down Bar Designed**
- **Switch:** Power ON/OFF Momentary(Dimple), System Reset
- **Dimensions (W x H x D):** 483 x 177 x 624mm (19" x 7" x 24.5")
- **Cuft:** 5.5
- **GW:** 22.1 kgs / 48.7 lbs
- **Carton Size (cm):** 80.0 x 33.1 x 59.0 (31.5" x 13" x 23.2")
- **Humidity:** 5% - 95% Non-condensing

Dimension

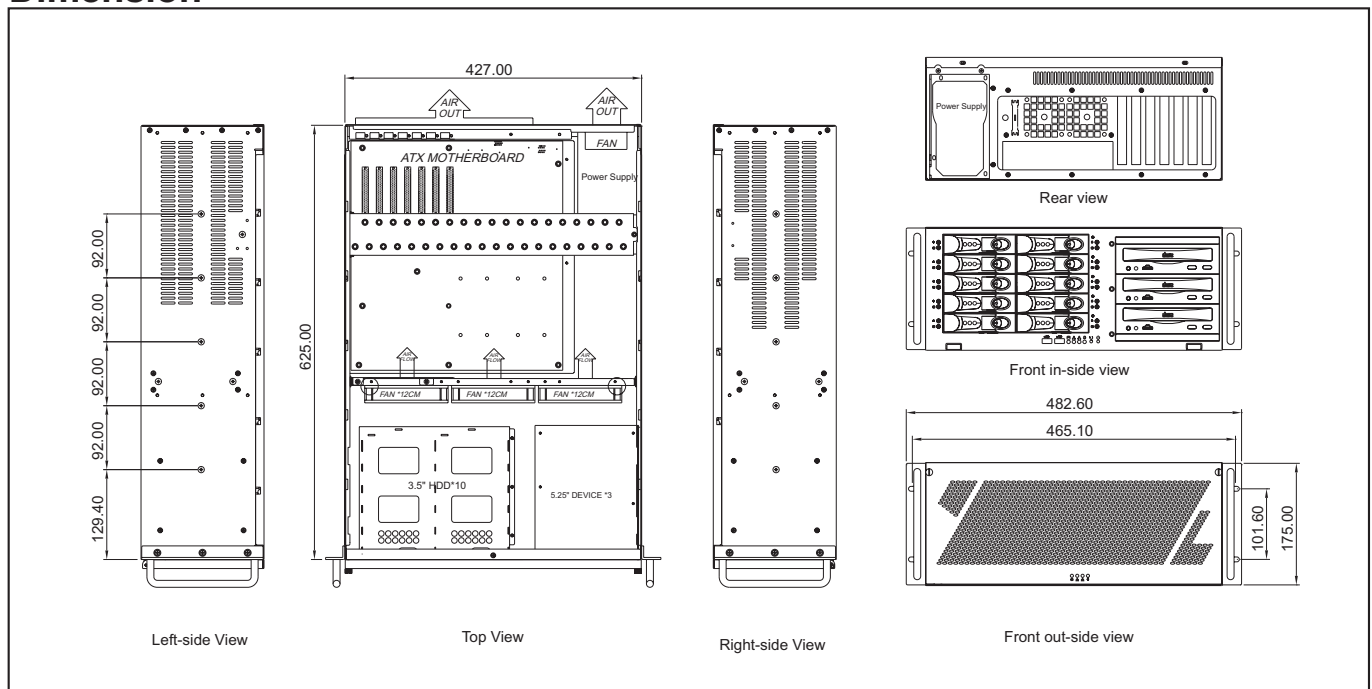

GHI-450

4U Wallmount Chassis



Specifications

- **Mounting:** Wall Mount
- **Construction:** Heavy Duty Cold Rolled Electroplated Steel
- **Color:** Black (Standard), Beige or Custom
- **System Boards:** Pentium 4, Dual Xeon, Athlon 64, Dual Opteron
- **Support EATX M/B(Max. to 12" x 13")**
- **Drive Capacity:** 2x 3.5"HDD & 1xSlim FDD & 1xSlim CD-ROM
- **Power Supply (Optional):** PS/2 Size Single up to 700W or Mini Redundant up to 500W ATX P/S (Rear Installation) Max. Depth 200mm
- **Cooling:** 4x (92mm = 51CFM ea.) Hot Swap Fans
- **Air Filter:** Inside Front Panel (Washable)
- **Indicators:** LEDs for Power ON/OFF, HDD Activity
- **Switch:** Power ON/OFF Momentary (Pushbutton), System Reset
- **Flexible Hold Down Bar Designed**
- **Dimensions (W x H x D):** 431 x 222 x 557mm (17" x 8.7" x 21.9")
- **Cuft:** 5.9
- **GW:** 22.4 kgs / 49.4 lbs
- **Carton Size(cm):** 57.5 x 42.5 x 70.5 (22.6" x 16.7" x 27.8")
- **Humidity:** 5% - 95% Non-condensing

Dimension

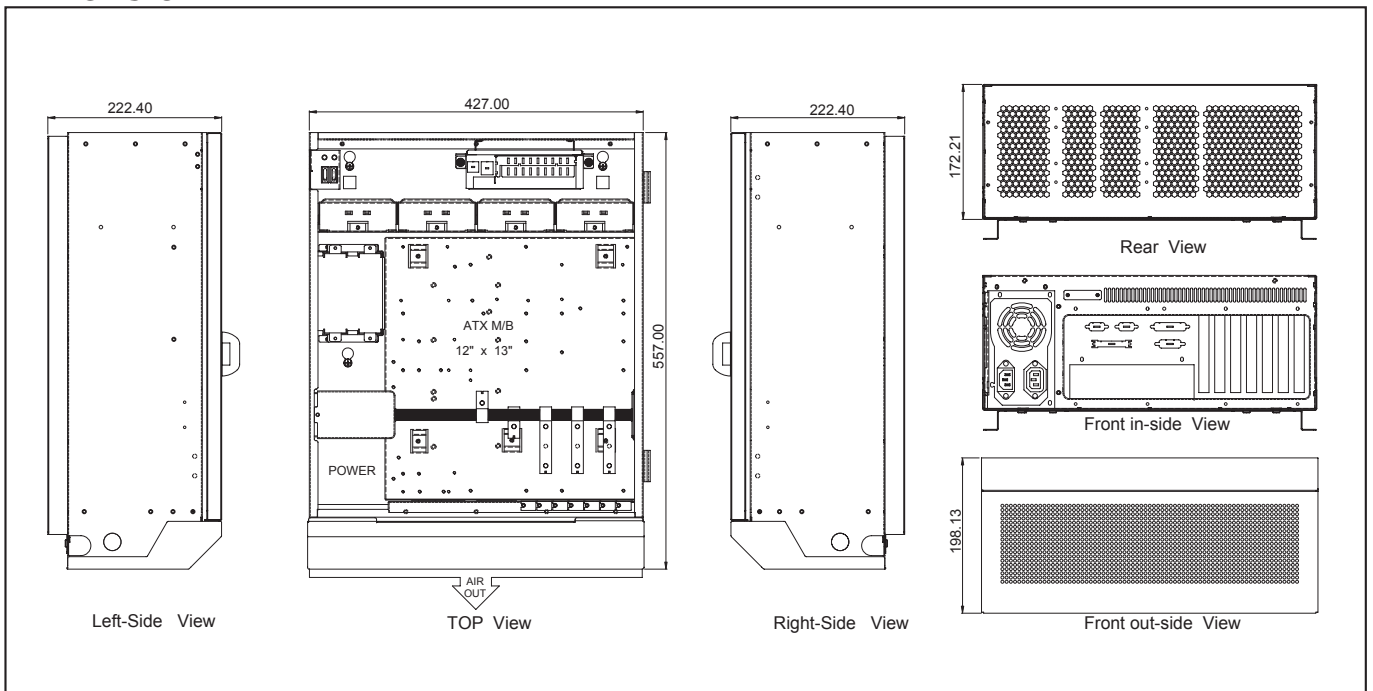

GHI-451ATXR/451SR

4U Wallmount Chassis

19" Rackmount

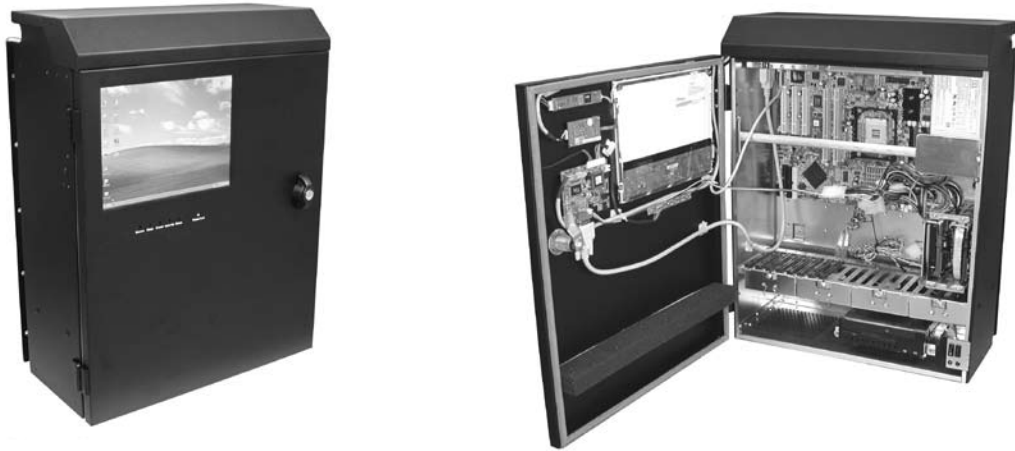

Specifications

- **Mounting:** Wall Mount
- **Construction:** Heavy Duty Cold Rolled Electroplated Steel
- **Color:** Black (Standard), Beige or Custom
- **System Boards:** Pentium 4, Dual Xeon, Athlon 64, Dual Opteron
- **Support EATX M/B (Max. to 12" x 13") SSI EEB3.0 (GHI-451ATXR)**
- **Support 14/15-Slot Passive Backplane (GHI-451SR)**
- **Drive Capacity:** 2x 3.5"HDD & 1xSlim FDD & 1xSlim CD-ROM
- **Power Supply (Optional):** PS/2 Size Single up to 700W or Mini Redundant up to 500W ATX P/S (Rear Installation) Max. Depth 200mm
- **Cooling:** 4x (92mm = 51CFM ea.) Hot Swap Fans
- **Air Filter:** Inside Front Panel (Washable)
- **LCD Size:** 10.4" TFT With 800x600 Resolution
- **Display Color:** Native 262K Colors
- **Luminance:** 230 cd/m2
- **Indicators:** LEDs for Power ON/OFF, HDD Activity
- **Flexible Hold Down Bar Designed**
- **Switch:** Power ON/OFF Momentary (Pushbutton), System Reset
- **Dimensions (W x H x D):** 431 x 222 x 557mm (17" x 8.7" x 21.9")
- **Cuft:** 5.7
- **GW:** 21.7 kgs / 47.9 lbs
- **Carton Size(cm):** 57 x 40 x 70.5 (22.4" x 15.8" x 27.8")
- **Humidity:** 5% - 95% Non-condensing

Dimension

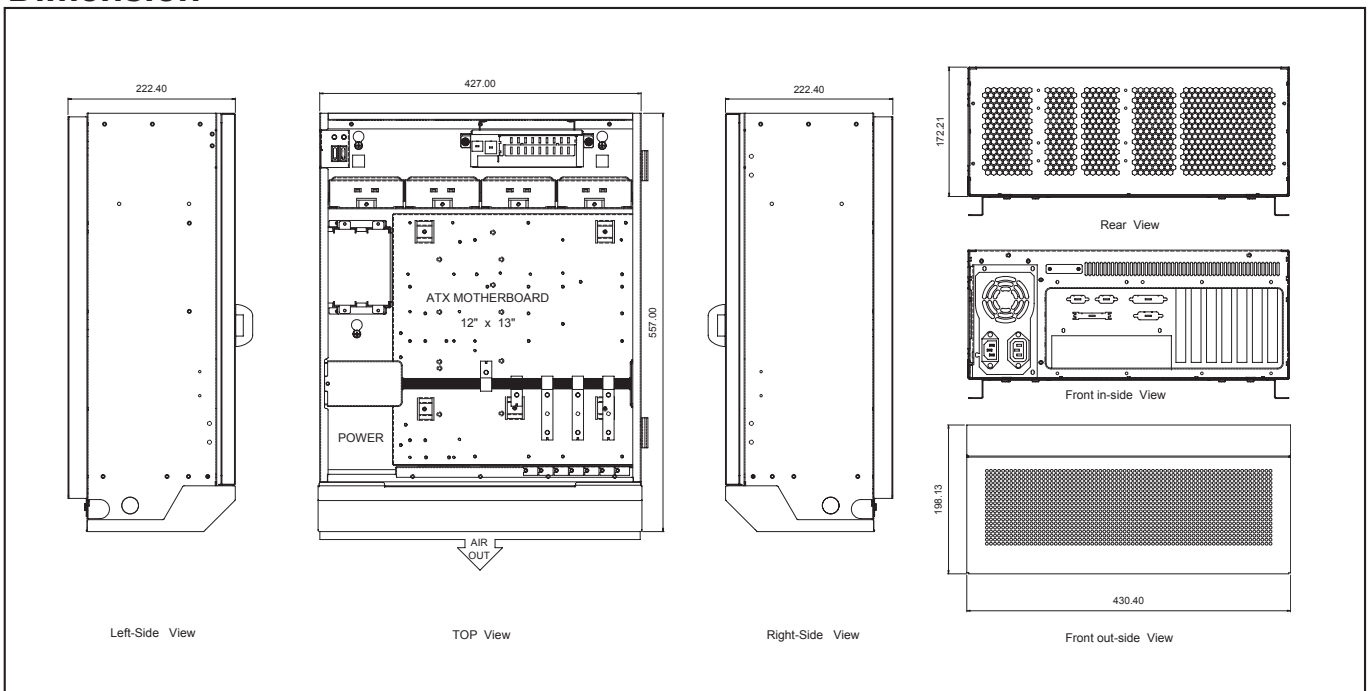

GHI-460

4U Rackmount/Tower Chassis



Specifications

- **EIA RS-310C 19" Rackmount Standard**
- **Construction:** Heavy Duty Cold Rolled Electroplated Steel
- **Color:** Black (Standard), Beige or Custom
- **System Boards:** Pentium 4, Dual Xeon, Athlon 64, Dual Opteron, Quad Opteron
- **Supports EATX M/B (Max. to 13" x 16") SSI EEB 3.0**
- **Drive Capacity:** 3x 5.25" CD-ROM & 5x 3.5"HDD
- **Power Supply :** N+1Redundant up to 950W ATX P/S (Front Installation) Max. Depth 300mm
- **Cooling:** 3x (92mm = 51CFM ea.) Hot Swapple Fans & 2x (80mm = 42.5CFM ea.) Fans
- **Front Door:** Single Door With 1 Thumbscrew

- **Thermal Management Card:** GHA-CO04
- **Connector Port (Front):** 2x USB Ports
- **Indicators:** LEDs for Power ON/OFF, HDD Power/Access/Fault, 2x LAN, Fan, Temperature
- **Switch:** Power ON/OFF Momentary(Rocker), System Reset, Buzzer Reset
- **Flexible Hold Down Bar Designed**
- **Dimensions (W x H x D):** 483 x 177 x 710mm (19" x 7" x 28")
- **Cuft:** 6.1
- **GW:** 23.2 kgs / 51.2 lbs
- **Carton Size (cm):** 56 x 34.5 x 89 (22.1" x 13.6" x 35")
- **Humidity:** 5% - 95% Non-condensing

Dimension

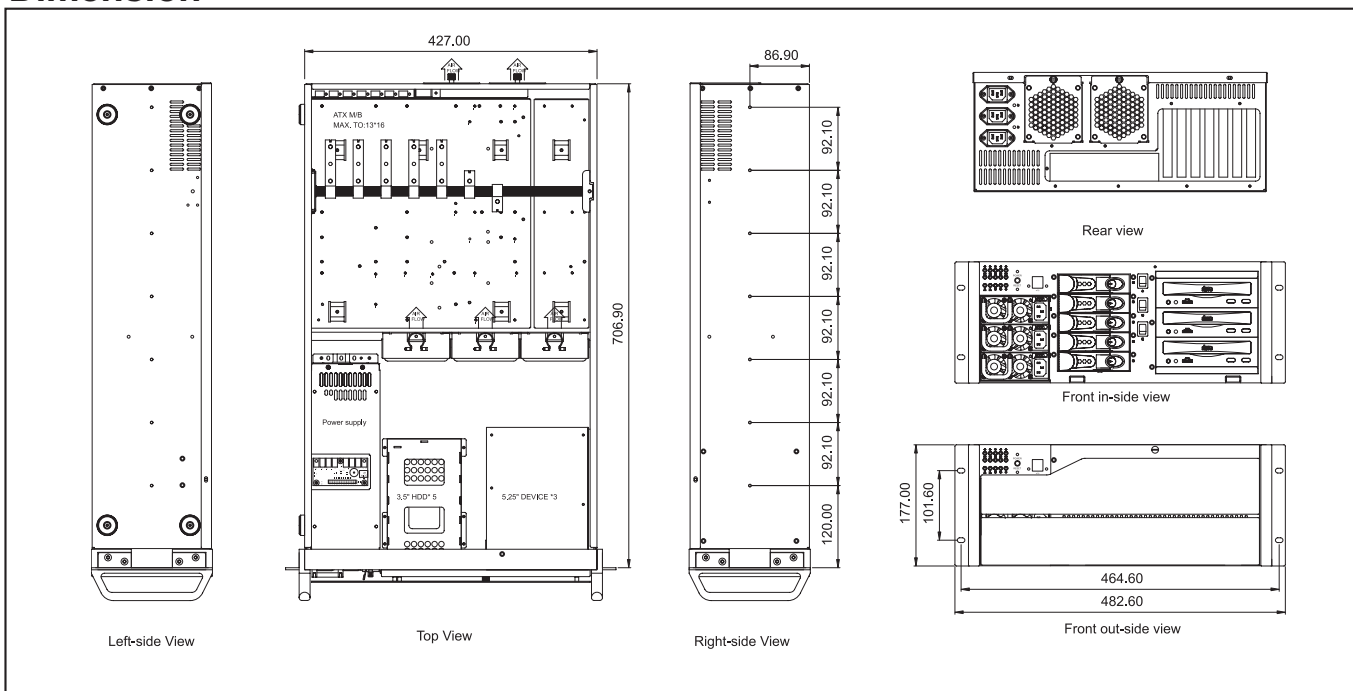

GHI-479

4U Rackmount Chassis



Specifications

- **EIA RS-310C 19" Rackmount Standard**
- **Construction:** Heavy Duty Cold Rolled Electroplated Steel
- **Color:** Black (Standard), Beige or Custom
- **System Boards:** Pentium 4, Dual Xeon, Athlon 64, Dual Opteron
- **Support ATX M/B (Max. to 12" x 9.6")**
- **Drive Capacity:** 2x 3.5" & 6x 5.25"
- **Power Supply (Optional):** PS/2 Size Single up to 700W or Mini Redundant up to 500W ATX P/S (Rear Installation) Max. Depth 220mm
- **Cooling:** 2x (80mm = 35CFM ea.) & 2x (60mm = 23.5CFM ea.) Fans
- **Front Door:** Single Door With Keylock
- **Connector Port (Front):** 2x USB Ports
- **Indicators:** LEDs for Power ON/OFF, HDD Activity
- **Flexible Hold Down Bar Designed**
- **Switch:** Power ON/OFF Momentary (Pushbutton), System Reset
- **Dimensions (W x H x D):** 483 x 177 x 510mm (19" x 7" x 20.1")
- **Cuft:** 4.9
- **GW:** 17.8 kgs / 39.3 lbs
- **Carton Size(cm):** 59.1 x 34 x 68.8 (23.3" x 13.4" x 27.1")
- **Humidity:** 5% - 95% Non-condensing

Dimension

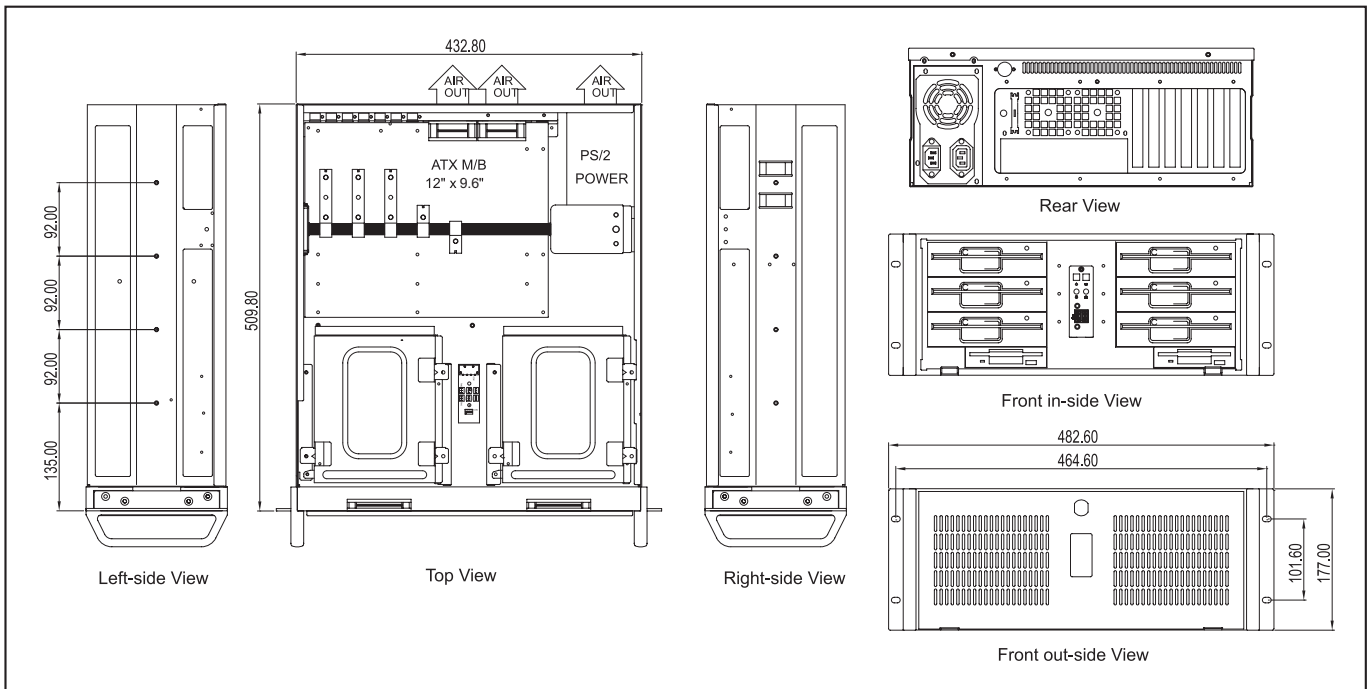

GHI-480

4U Rackmount Chassis



Specifications

- **EIA RS-310C 19" Rackmount Standard**
- **Construction:** Heavy Duty Cold Rolled Electroplated Steel
- **Color:** Black (standard), Beige or Custom
- **System Boards:** Pentium 4, Dual Xeon, Athlon 64, Dual Opteron
- **Support EATX M/B (Max. to 12" x 13") SSI EEB 3.0**
- **Drive Capacity:** 1xSlim CD-ROM & 1xSlim FDD & 16x3.5"Swappable IDE/SATA/SCSI 320/ Multilane SATA/SAS (Optional)Trays & 2x2.5"HDD & 2 x 3.5"HDD(Optional)
- **Power Supply (Optional):** N+1 Redundant up to 950W ATX P/S (Rear Installation)
- **Cooling:** 3x(12cm) Fans(90CFM ea.) & 2x(6cm) Fans(23.5CFM ea.) (Optional)
- **Front Door:** Single Door with 2 Thumb Screws(Removable)
- **Connector Port(Front):** 2xUSB Ports
- **Thermal Management Card:** GHA-CO04
- **Indicators:** LEDs for Power ON/OFF, HDD Activity, Fan, Temperature, LAN
- **Flexible Hold Down Bar Designed**
- **Switch:** Power ON/OFF Momentary (Dimple), System Reset, Buzzer Reset
- **Dimensions(WxHxD):** 483x177x 650mm(19"x7" x 25.6")
- **Cuft:** 5.8
- **GW:** 28.0kgs / 61.7lbs
- **Carton Size(cm):** 85.4 x 33.6 x 57.6(33.6" x 13.2" x 22.7")
- **Humidity:** 5% - 95% Non-condensing

Dimension

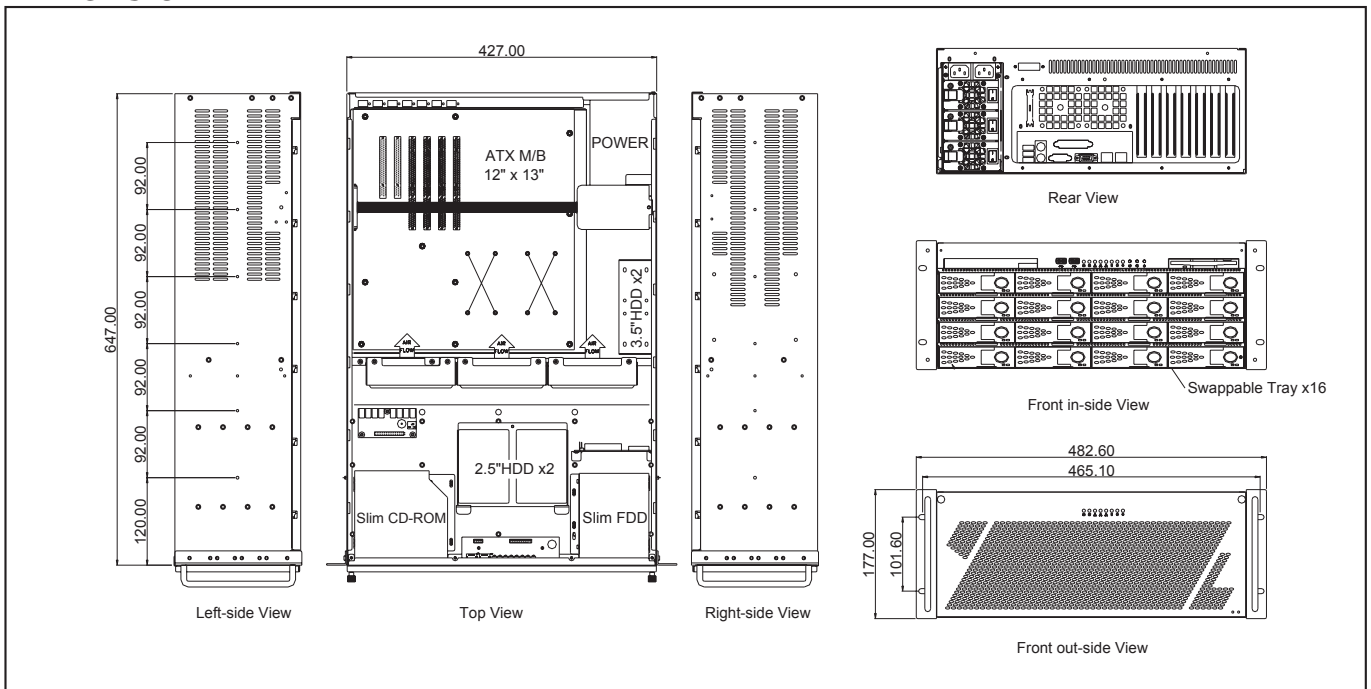

GHI-481

4U Rackmount Chassis



Specifications

- **EIA RS-310C 19" Rackmount Standard**
- **Construction:** Heavy Duty Cold Rolled Electroplated Steel
- **Color:** Black (Standard), Beige or Custom
- **System Boards:** Pentium 4, Dual Xeon, Athlon 64, Dual Opteron
- **Support EATX M/B (Max. to 12" x 13") SSI EEB 3.0**
- **Drive Capacity:** 1x5.25" & 1xSlim CD-ROM & 1xSlim FDD & 14x3.5"Swappable IDE/SATA/SCSI 320/ Multilane SATA/SAS(Optional)Trays & 2 x 3.5"HDD(Optional)
- **Power Supply (Optional):** N+1 Redundant up to 950W ATX P/S (Rear Installation)
- **Cooling:** 3x(120mm = 90CFM ea.) Fans & 2x(60mm = 23.5CFM ea.) Fans (Optional)
- **Front Door:** Single Door with 2 Thumb Screws(Removable)
- **Connector Port(Front):** 2x USB Ports
- **Thermal Management Card:** GHA-CO04
- **Indicators:** LEDs for Power ON/OFF, HDD Activity, Fan, Temperature, LAN
- **Flexible Hold Down Bar Designed**
- **Switch:** Power ON/OFF Momentary (Dimple), System Reset, Buzzer Reset
- **Dimensions(WxHxD):** 483 x 177 x 650mm (19" x 7" x 25.6")
- **Cuft:** 5.8
- **GW:** 28.0 kgs / 61.7 lbs
- **Carton Size(cm):** 85.4 x 33.6 x 57.6(33.6" x 13.2" x 22.7")
- **Humidity:** 5% - 95% Non-condensing

Dimension

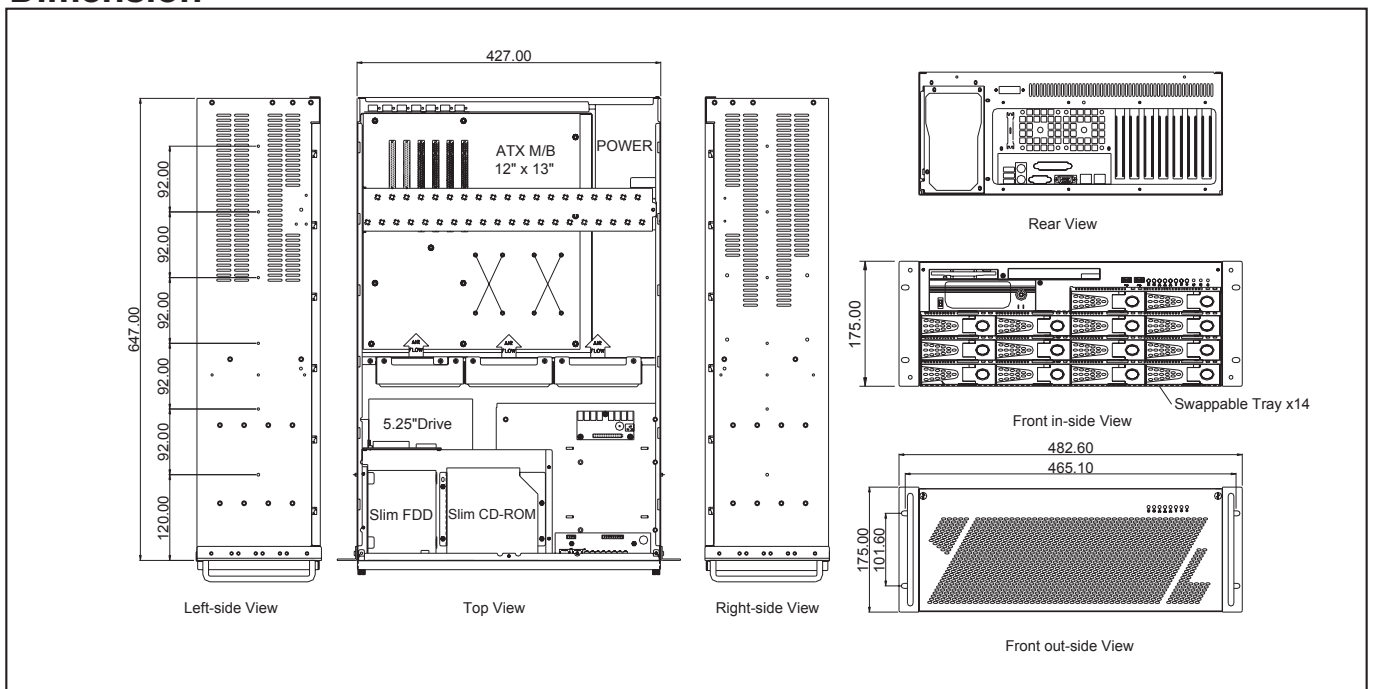

GHI-4F2ATXR

4U Rackmount Chassis

19" Rackmount



Specifications

- **EIA RS-310C 19" Rackmount Standard**
- **Construction:** Heavy Duty Cold Rolled Electroplated Steel
- **Color:** Black (Standard), Beige or Custom
- **System Boards:** Pentium 4, Dual Xeon, Athlon 64, Dual Opteron
- **Support EATX M/B (Max. to 12" x 13") SSI EEB 3.0**
- **Drive Capacity:** 1 x 5.25" CD-ROM & 1x 3.5" FDD & 2x 3.5" HDD
- **Power Supply (Optional):** 3U N+1 Redundant up to 650W ATX P/S (Front Installation) Max. Depth 300mm
- **Cooling:** 2x (90mm = 51CFM ea.) Fans
- **Connector Port (Front):** 2x USB Ports
- **Indicators:** LEDs for Power ON/OFF, HDD Activity
- **Switch:** Power ON/OFF Momentary (Rocker), System Reset
- **Flexible Hold Down Bar Designed**
- **Dimensions (W x D x H):** 483 x 177 x 447mm (19" x 7" x 17.6")
- **Cuft:** 4.4
- **GW:** 15.6 kgs / 34.4 lbs
- **Carton Size(cm):** 61.8 x 34 x 59 (24.3" x 13.4" x 23.2")
- **Humidity:** 5% - 95% Non-condensing

Dimension

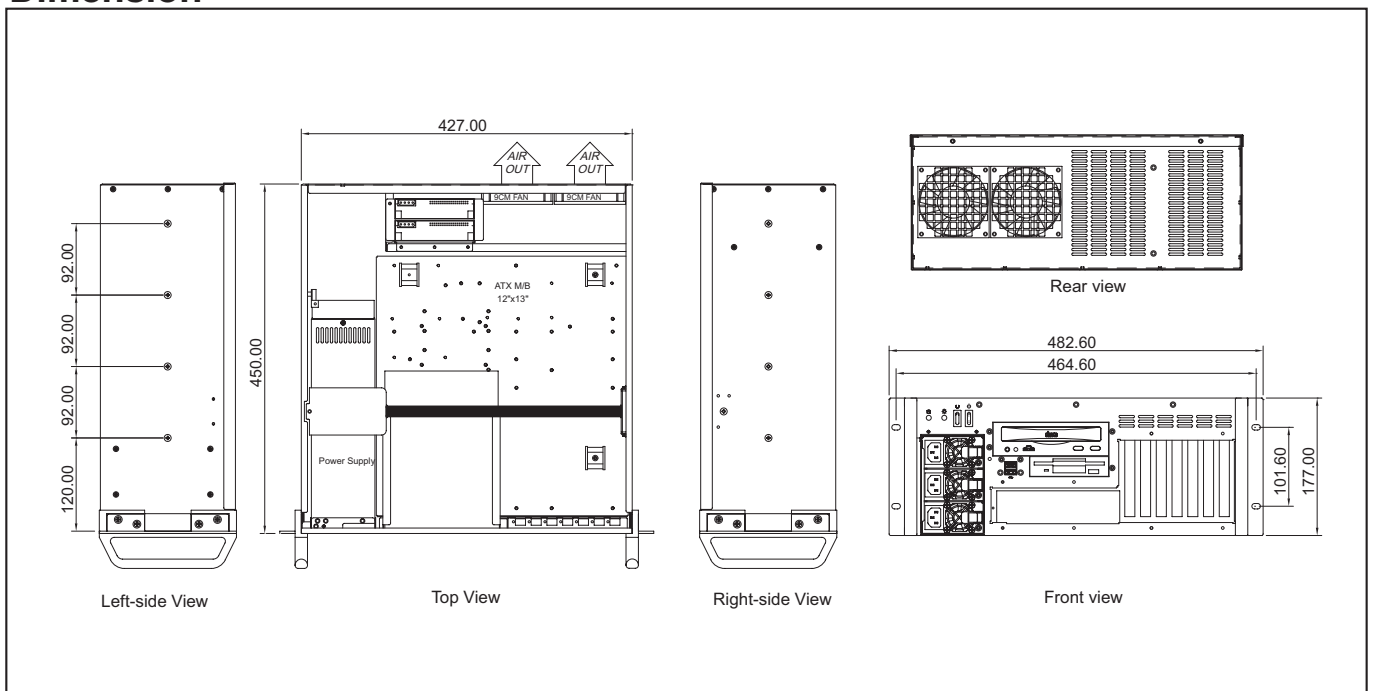

GHI-M40ATXR/M40SR

4U Rackmount Chassis



Specifications

- **EIA RS-310C 19" Rackmount Standard**
- **Construction:** Heavy Duty Cold Rolled Electroplated Steel
- **Color:** Black (Standard), Beige or Custom
- **System Boards:** Pentium 4, Athlon 64, Dual Xeon, Dual Opteron
- **Support ATX M/B (Max. to 12" x 10.5") SSI EEB3.0 (GHI-M40ATXR)**
- **Support 14/15-Slot Passive Backplane (GHI-M40SR)**
- **Drive Capacity:** 1x 5.25" Slim CD-ROM & 4x 3.5" Swappable Trays & 3x 3.5"HDD
- **Power Supply (Optional):** PS/2 Size Single up to 700W or Mini Redundant up to 500W ATX P/S (Rear Installation) Max. Depth 220mm
- **Cooling:** 3x (92 mm = 51.0CFM ea.) Fans
- **Keyboard:** 83/84 Key With Integrated Track Ball+2 Mouse Buttons
- **Connector Port (Front):** 2x USB Ports
- **LCD Size:** 6.4" TFT With 640*480 Resolution
- **Display Colors:** 262,144 Colors
- **Indicators:** LEDs for Power ON/OFF, HDD Activity
- **Switch:** Power ON/OFF, System Reset , Brightness, Contrast, Menu
- **Dimensions (W x H x D):** 483 x 177 x 510mm (19" x 7" x 20.1")
- **Cuft:** 4.9
- **GW:** 20.2 kgs / 44.5 lbs
- **Carton Size(cm):** 59.1 x 34.0 x 68.8 (23.3" x 13.4" x 27.1")
- **Humidity:** 5% - 95% Non-condensing

Dimension

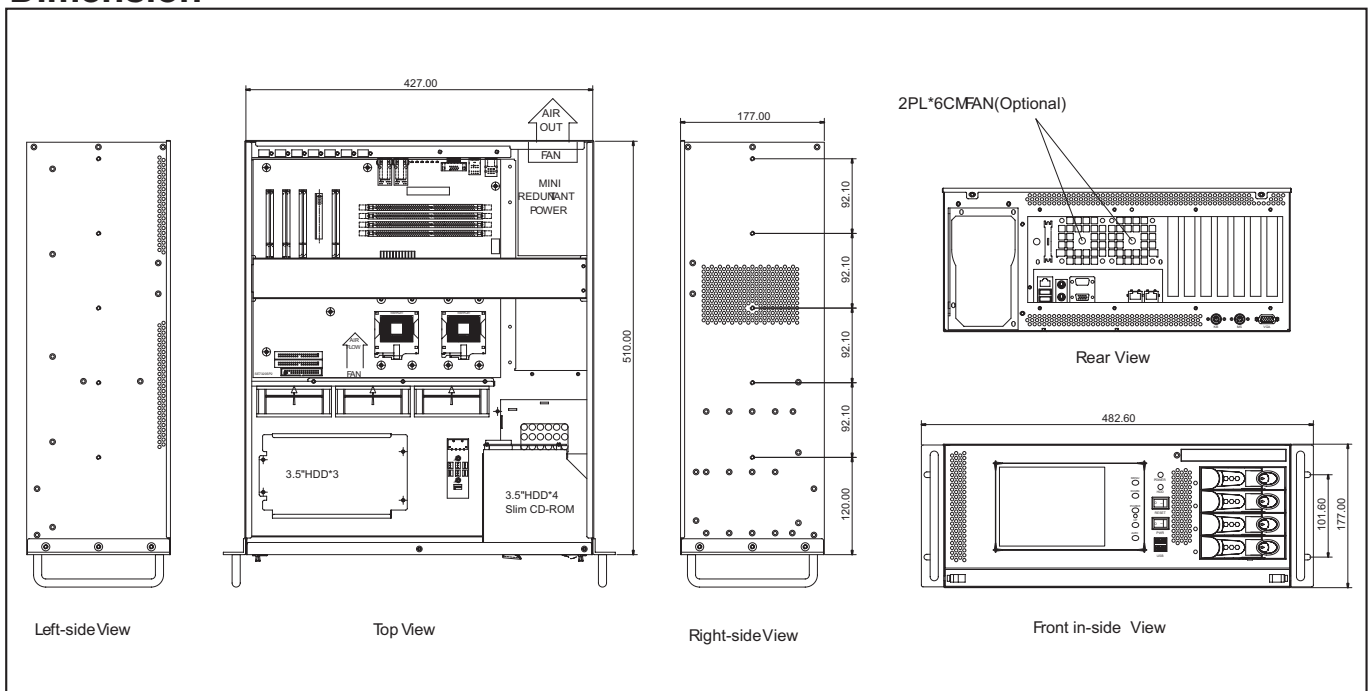

GHI-M41ATXR/M41SR

4U Rackmount Chassis



19" Rackmount

Specifications

- **EIA RS-310C 19" Rackmount Standard**
- **Construction:** Heavy Duty Cold Rolled Electroplated Steel
- **Color:** Black (Standard), Beige or Custom
- **System Boards:** Pentium 4, Athlon 64, Dual Xeon, Dual Opteron
- **Support ATX M/B (Max. to 12" x 10.5") SSI EEB3.0 (GHI-M41ATXR)**
- **Support 14/15-Slot Passive Backplane (GHI-M41SR)**
- **Drive Capacity:** 1x 5.25" & 3x 3.5" Swappable Trays & 3x 3.5"HDD
- **Power Supply (Optional):** PS/2 Size Single up to 700W or Mini Redundant up to 500W ATX P/S (Rear Installation) Max. Depth 220mm
- **Cooling:** 3x (92 mm = 51.0CFM ea.) Fans & 2x (60 mm =23.5CFM ea.)(for ATX M/B-Optional) Fans
- **Keyboard:** 83/84 Key With Integrated Track Ball+2 Mouse Buttons
- **Connector Port (Front):** 2x USB Ports
- **LCD Size:** 7" TFT With 800*480 Resolution
- **Display Colors:** 262,144 colors
- **Indicators:** LEDs for Power ON/OFF, HDD Activity
- **Switch:** Power ON/OFF, System Reset , Brightness, Contrast, Menu
- **Dimensions (W x H x D):** 483 x 177 x 510mm (19" x 7" x 20.1")
- **Cuft:** 4.9
- **GW:** 19.6 kgs / 43.2 lbs
- **Carton Size(cm):** 59.1 x 34 x 68.8 (23.3" x 13.4" x 27.1")
- **Humidity:** 5% - 95% Non-condensing

Dimension

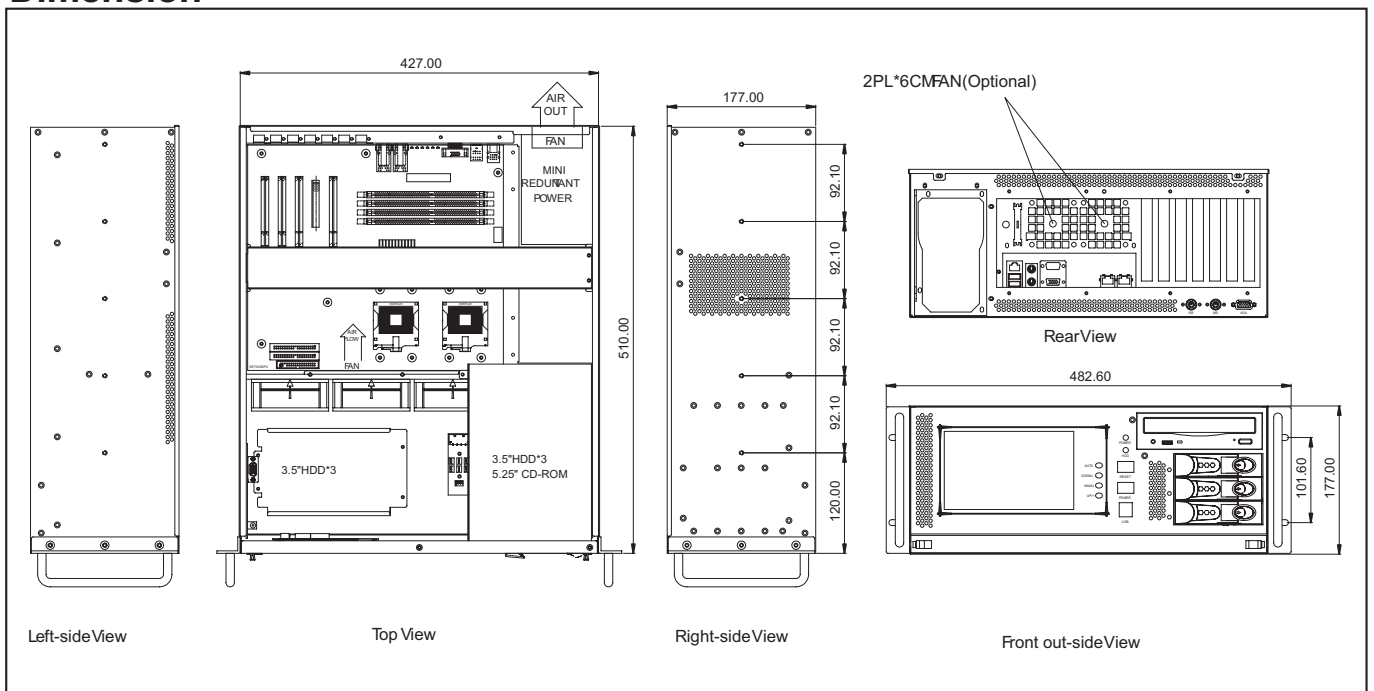

GHI-P02

4U Rackmount Chassis



Specifications

- **Meet 19" 4U Height Rack-mount Enclosure With 10 x 1U Blade**
- **Constructions:** Heavy Duty Cold Rolled Steel
- **Color:** Black (Standard), Beige or Custom
- **System Boards:** Intel @ Server Board S3000PT (13" x 6")
- **Drive Capacity:** 2x 2.5"HDD Per Blade
- **Power Supply (Optional):** 1x 275W (152.0 x 81.5 x 40.5mm) ATX P/S Per Blade
- **Cooling:** 2x (40x28mm = 15CFM ea.) Fans Per Blade & 4x (92mm = 52CFM ea.) AC Fans for The Enclosure
- **Front Door:** Snap Lock With Filter (Washable)
- **Connectors (Rear):** 2x RJ45 Per Blade
- **Expansion Slots:** 1x Horizontal PCI Slot Per Blade
- **Indicators:** LEDs for Power ON/OFF Momentary (Square Pushbutton), HDD Activity
- **Switch:** Power ON/OFF, System Reset
- **Dimensions (W x H x D):** 483 x 177 x 647mm (19" x 7" x 25.5")
- **Cuft:** 5.8
- **GW:** 38.4 kgs / 84.7 lbs
- **Carton Size(cm):** 85.4 x 33.6 x 57.6 (33.6" x 13.2" x 22.7")
- **Humidity:** 5% - 95% Non-condensing

Dimension

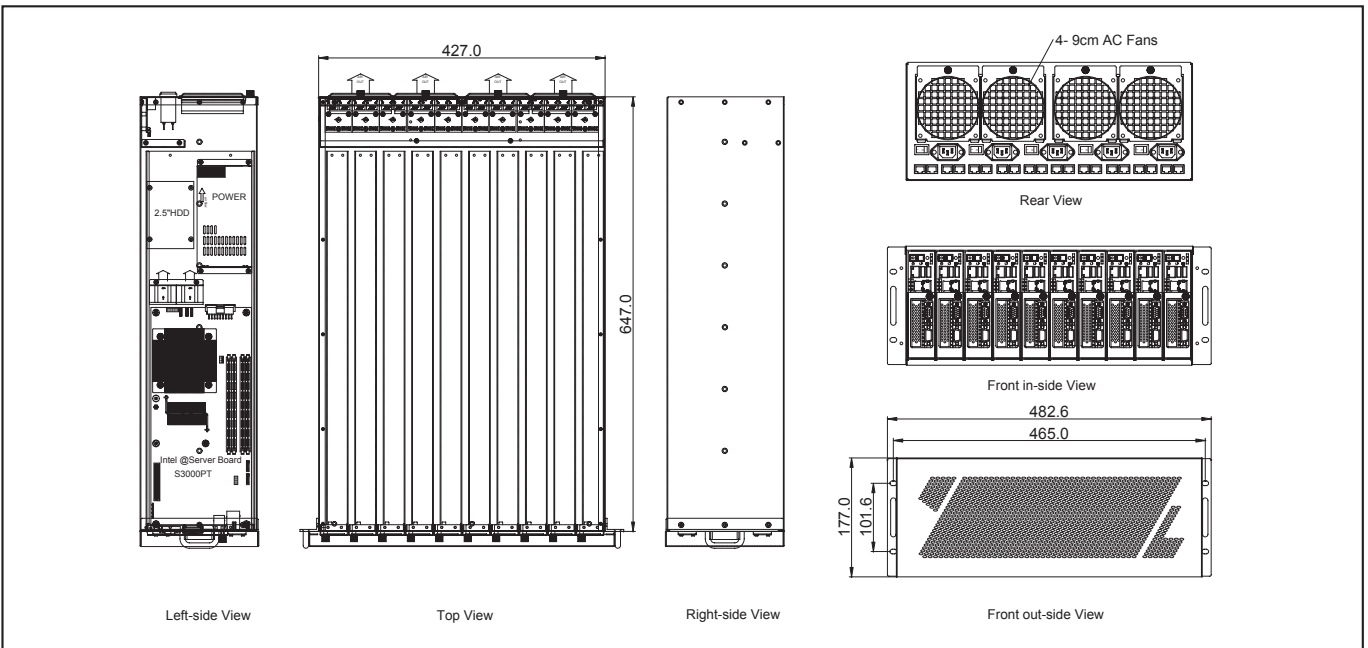

GH-520SR/530ATXR

5U Rackmount Chassis



19" Rackmount

Specifications

- **EIA RS-310C 19" Rackmount Standard**
- **Construction:** Heavy Duty Cold Rolled Electroplated Steel
- **Color:** Black (Standard), Beige or Custom
- **System Boards:** Pentium 4, Dual Xeon, Athlon 64, Dual Opteron
- **Support 20-slot Passive Backplane (520SR)**
- **Support EATX M/B (Max. to 13" x 16") SSI EEB 3.0 (530ATXR)**
- **Drive Capacity:** 4x 5.25" & 1x 3.5"
- **Power Supply (Optional):** Vertical Redundant up to 400W ATX P/S or DC to DC-48V 300W P/S(Front Installation) Max. Depth 220mm
- **Cooling:** Hot Swappable 4x(9cm) Fans(51CFM ea.) or Hot Swappable 3x (120mm = 90CFM ea.) Fans (Optional)
- **Air Filter:** Inside Front Door (Washable)
- **Front Door:** Single Door with 1 Thumb Twist Keylock
- **Thermal Management Card:** GHA-CO01
- **Indicators:** LEDs for Power ON/OFF, HDD Activity, Fan, Temperature
- **Flexible Hold Down Bar Designed**
- **Switch:** Power ON/OFF Momentary or AT (Pushbutton), System Reset, Buzzer Reset
- **Dimensions (WxHxD):** 483 x 222 x 671mm (19" x 8.75" x 26.4")
- **Cuft:** 6.8
- **GW:** 26.0 kgs / 57.3 lbs
- **Carton Size(cm):** 61 x 37 x 85.5 (24" x 14.6" x 33.7")
- **Humidity:** 5% - 95% Non-condensing

Dimension

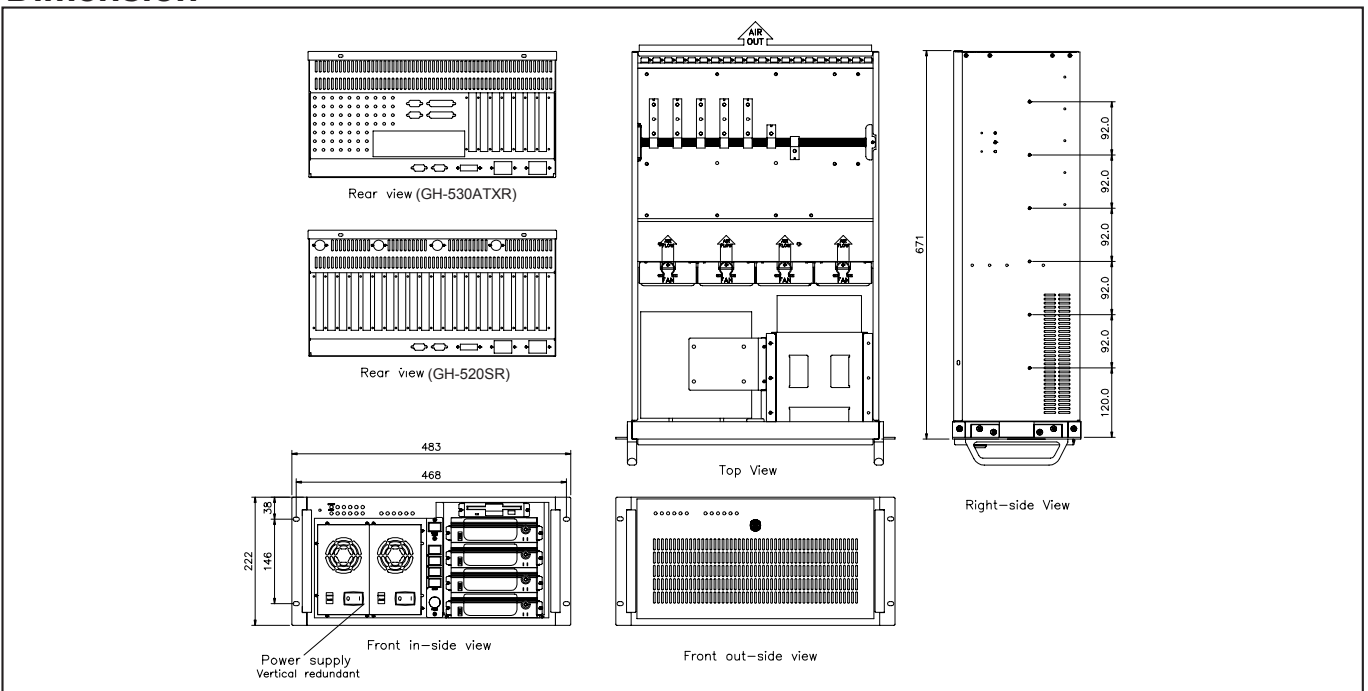

GHI-528

5U Rackmount Chassis



Specifications

- **EIA RS-310C 19" Rackmount Standard**
- **Construction:** Heavy Duty Cold Rolled Electroplated Steel
- **Color:** Black (Standard), Beige or Custom
- **Support 20-slot Passive Backplane or EATX M/B (Max. to 12" x 13")**
- **Drive Capacity:** 8x 5.25" & 1x 3.5"
- **Power Supply (Optional):** 1U Redundant up to 1650W ATX P/S
- **Cooling:** Hot Swappable 4x (90mm= 51CFM ea.) Fans
- **Front Door:** Single Door With Keylock
- **Air Filter:** Inside Front Door (Washable)
- **Thermal Management Card:** GHA-CO04
- **Indicators:** LEDs for Power ON/OFF, HDD Activity, Fan, Temperature
- **Flexible Hold Down Bar Designed**
- **Switch:** Power ON/OFF (Momentary), System Reset, Buzzer Reset
- **Dimensions (W x H x D):** 483 x 222 x 670mm (19" x 8.8" x 26.4")
- **Cuft:** 6.8
- **GW:** 20.4 kgs / 45 lbs
- **Carton Size (cm):** 61 x 37 x 85.5 (24" x 14.6" x 33.7")
- **Humidity:** 5% - 95% Non-condensing

Dimension

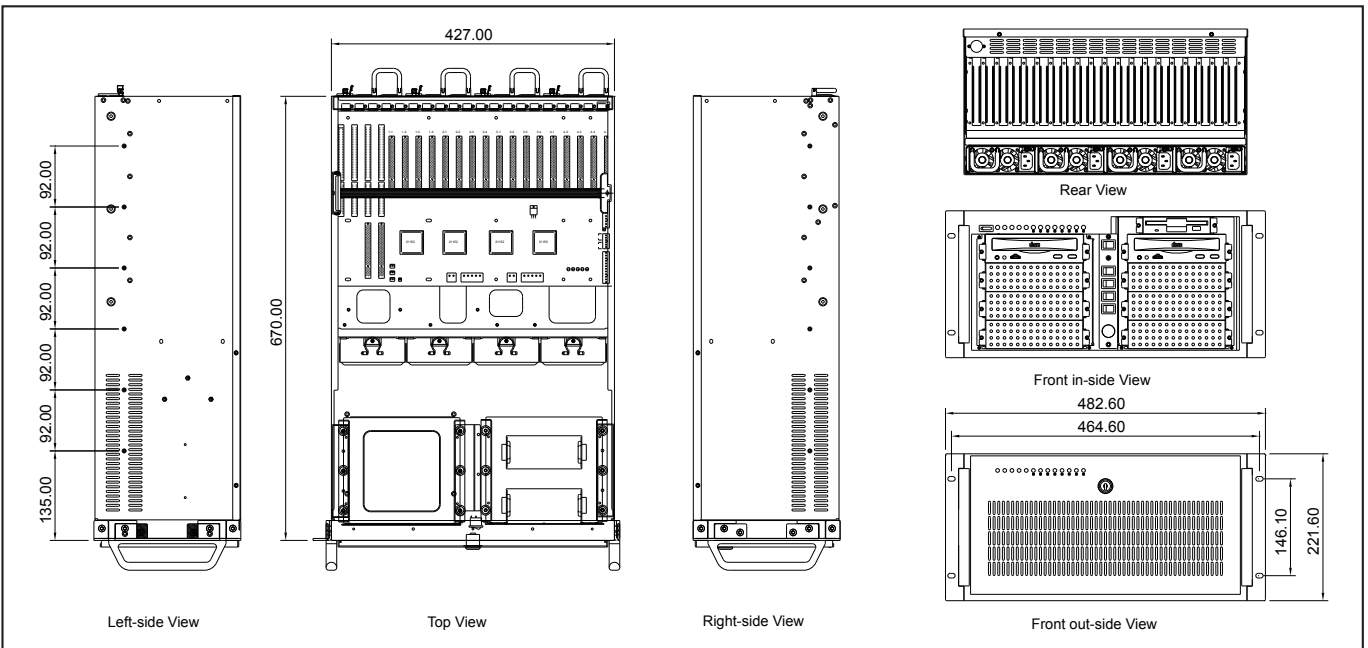

GHI-580

5U Rackmount Chassis

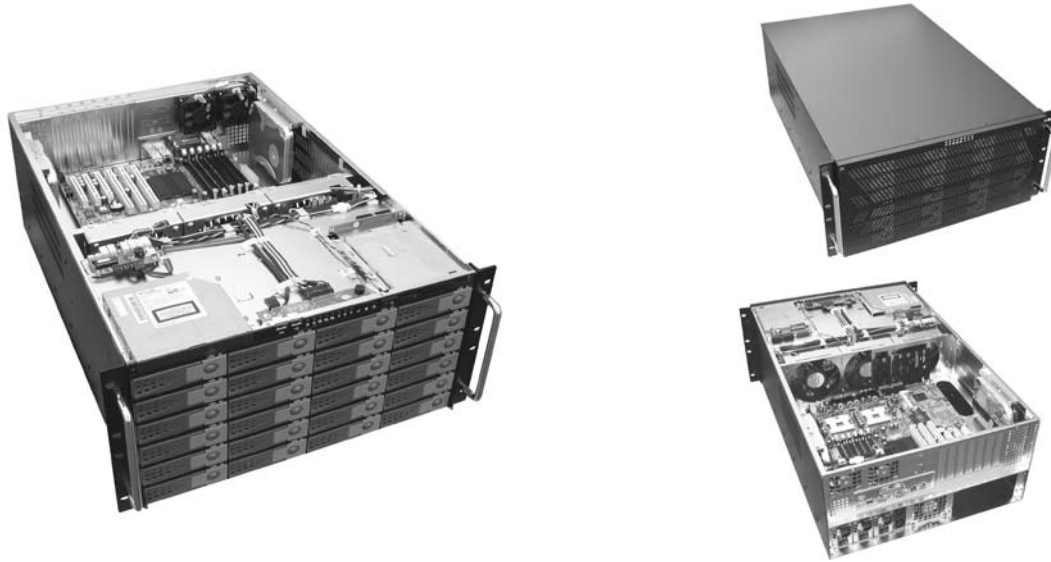

19" Rackmount

Specifications

- **EIA RS-310C 19" Rackmount Standard**
- **Construction:** Heavy Duty Cold Rolled Electroplated Steel
- **Color:** Black (Standard), Beige or Custom
- **System Boards:** Pentium 4, Dual Xeon, Athlon 64, Dual Opteron, Quad Opteron
- **Support EATX M/B (Max. to 12" x 13") SSI EEB 3.0 With Removable Drawer**
- **Drive Capacity:** 1x Slim CD-ROM & 1x Slim FDD & 24x 3.5"Swappable, 2x 2.5"HDD & 2 x 3.5"HDD(Optional)
- **Drive Interface:** PATA, SATA, SCSI320, Multilane SATA or SAS
- **Power Supply (Optional):** 2x Redundant up to 500W ATX P/S ea. (Rear Installation) Max. Depth 275mm
- **Cooling:** 3x (120mm = 90CFM ea.) Fans & 1x (80mm = 42.5CFM ea.) Fan & 2x (60mm = 23.5CFM ea.) Fans
- **Front Door:** Single Door with 2 Thumbscrews(Removable)
- **Connector Port (Front):** 2x USB Ports
- **Thermal Management Card:** GHA-CO04
- **Indicators:** LEDs for Power ON/OFF, HDD Activity, Fan, Temperature, LAN
- **Flexible Hold Down Bar Designed**
- **Switch:** Power ON/OFF Momentary (Dimple), System Reset, Buzzer
- **Dimensions (WxHxD):** 483 x 222 x 650mm (19" x 8.7" x 25.6")
- **Cuft:** 6.8
- **GW:** 33.5 kgs / 73.9 lbs
- **Carton Size (cm):** 85.5 x 37 x 61(33.7" x 14.6" x 24")
- **Humidity:** 5% - 95% Non-condensing

Dimension

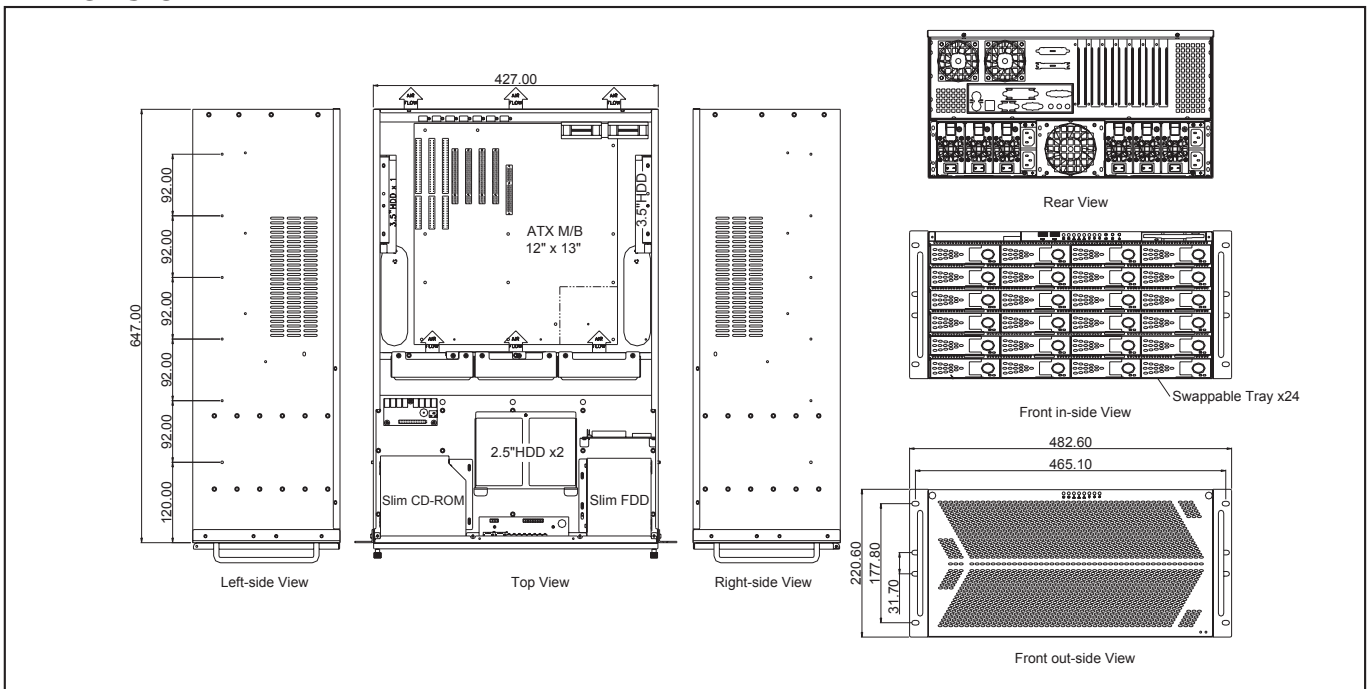

GHI-581

5U Rackmount Chassis



Specifications

- **EIA RS-310C 19" Rackmount Standard"**
- **Construction:** Heavy Duty Cold Rolled Electroplated Steel
- **Color:** Black (Standard), Beige or Custom
- **System Boards:** Pentium 4, Dual Xeon, Athlon 64, Dual Opteron
- **Supports EATX M/B (Max. to 12" x 13") SSI EEB 3.0 With Removable Drawer**
- **Drive Capacity:** 1x 5.25", 1x Slim FDD & 22x 3.5" Hot Swappable Trays & 1x 2.5"HDD & 2x 3.5"HDD (Optional)
- **Drive Interface:** PATA, SATA, SCSI320, Multilane SATA or SAS
- **Power Supply (Optional):** 2x Redundant up to 500W ATX P/S ea. (Rear Installation) Max. Depth 275mm
- **Cooling:** 3x (120mm = 90CFM ea.) Fans & 1x (80mm = 42.5CFM ea.) Fan & 2x (60mm = 23.5CFM ea.) Fans
- **Front Door:** Single Door with 2 Thumbscrews (Removable)
- **Connector Port (Front):** 2x USB Ports
- **Thermal Management Card:** GHA-CO04
- **Indicators:** LEDs for Power ON/OFF, HDD Activity, Fan, Temperature, LAN
- **Flexible Hold Down Bar Designed**
- **Switch:** Power ON/OFF Momentary (Dimple), System Reset, Buzzer Reset
- **Dimensions (WxHxD):** 483x 222 x 650mm(19"x8.7"x25.6")
- **Cuft:** 6.8
- **GW:** 33.5 kgs / 73.9 lbs
- **Carton Size (cm):** 85.5 x 37 x 61 (33.7" x 14.6" x 24")
- **Humidity:** 5% - 95% Non-condensing

Dimension

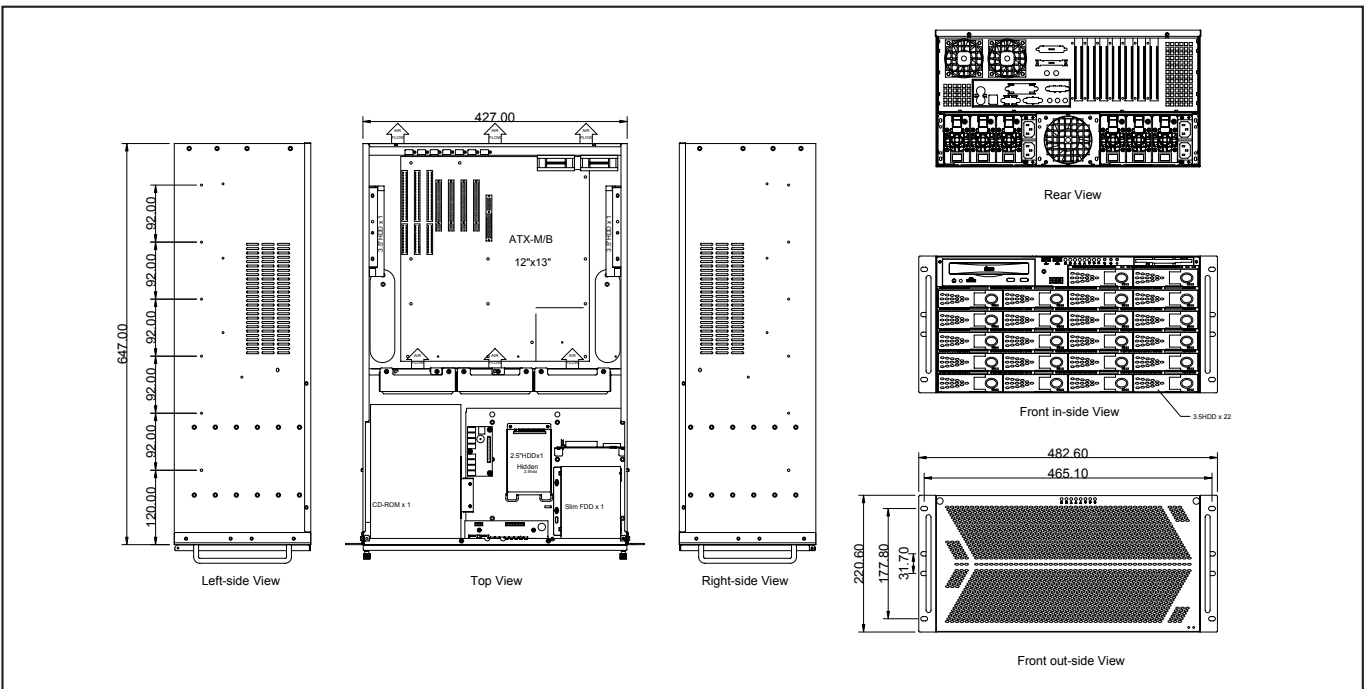

GHI-583

5U Rackmount Chassis



19" Rackmount

Specifications

- **EIA RS-310C 19" Rackmount Standard**
- **Construction:** Heavy Duty Cold Rolled Electroplated Steel
- **Color:** Black (Standard), Beige or Custom
- **System Boards:** Pentium 4, Dual Xeon, Athlon 64, Dual Opteron, Quad Opteron
- **Supports EATX M/B (Max. to 13" x 16") With Removable Drawer**
- **Drive Capacity:** 1x Slim CD-ROM, 1x Slim FDD & 24x 3.5" Hot Swappable & 2x 2.5" HDD & 2 x 3.5" HDD (Optional)
- **Drive Interface:** PATA, SATA, SCSI320, Multilane SATA or SAS
- **Power Supply (Optional):** 1U Redundant up to 1650W ATX P/S (Rear Installation) Max. Depth 300mm
- **Cooling:** 4x (92mm = 51CFM ea.) Fans & 3x (60mm 23.5CFM ea.) Fans
- **Front Door:** Single Door with 2 Thumbscrews(Removable)
- **Connector Port (Front):** 2x USB Ports
- **Thermal Management Card:** GHA-CO04
- **Indicators:** LEDs for Power ON/OFF, HDD Activity, Fan, Temperature, LAN
- **Flexible Hold Down Bar Designed**
- **Switch:** Power ON/OFF Momentary (Dimple), System Reset, Buzzer Reset
- **Dimensions(WxHxD):** 483 x 222 x 650mm (19" x 8.7" x 25.6")
- **Cuft:** 6.8
- **GW:** 33.5 kgs / 73.9 lbs
- **Carton Size (cm):** 85.5 x 37 x 61 (33.7"x14.6"x 24")
- **Humidity:** 5% - 95% Non-condensing

Dimension

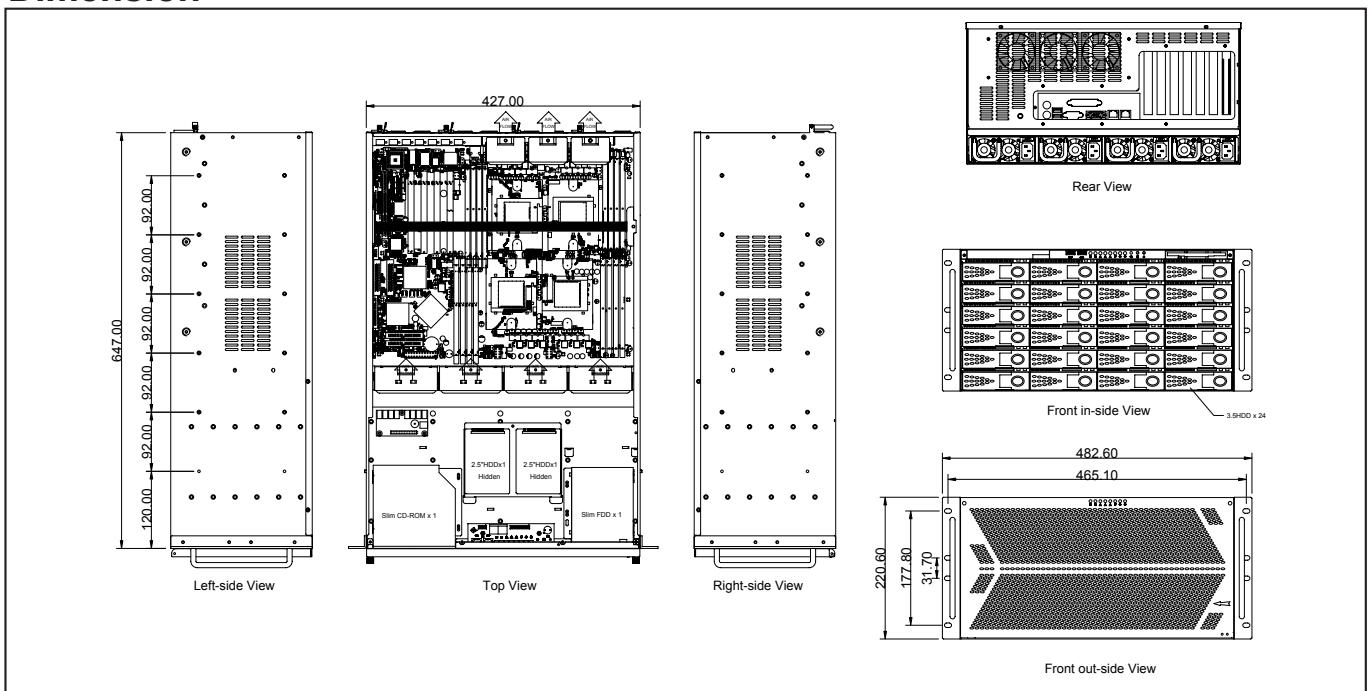

GHI-584

5U Rackmount Chassis



Specifications

- **EIA RS-310C 19" Rackmount Standard**
- **Construction:** Heavy Duty Cold Rolled Electroplated Steel
- **Color:** Black (Standard), Beige or Custom
- **System Boards:** Pentium 4, Dual Xeon, Athlon 64, Dual Opteron, Quad Opteron
- **Supports Dual EATX M/B (Max. to 13" x 16") With Removable Drawer**
- **Drive Capacity:** 1x Slim CD-ROM, 1x Slim FDD & 24x 3.5" Hot Swappable & 2x 2.5" HDD
- **Drive Interface:** PATA, SATA, SCSI320, Multilane SATA or SAS
- **Power Supply (Optional):** 1U Redundant up to 1650W ATX P/S (Rear Installation) Max. Depth 300mm
- **Cooling:** 6x (60mm = 23.5CFM ea.) Fans & 2x (120mm = 90CFM ea.) Fans
- **Front Door:** Single Door With 2 Thumbscrews (Removable)
- **Connector Port (Front):** 2x USB Ports
- **Thermal Management Card:** GHA-CO04
- **Indicators:** LEDs for Power ON/OFF, HDD Activity, Fan, Temperature, LAN
- **Flexible Hold Down Bar Designed**
- **Switch:** Power ON/OFF Momentary (Dimple), System Reset, Buzzer Reset
- **Dimensions (W x H x D):** 483 x 222 x 650mm (19.0" x 8.7" x 25.6")
- **Cuft:** 6.8
- **GW:** 34.5 kgs / 76.1 lbs
- **Carton Size (cm):** 85.5 x 37 x 61. (33.7" x 14.6" x 24")
- **Humidity:** 5% - 95% Non-condensing

Dimension

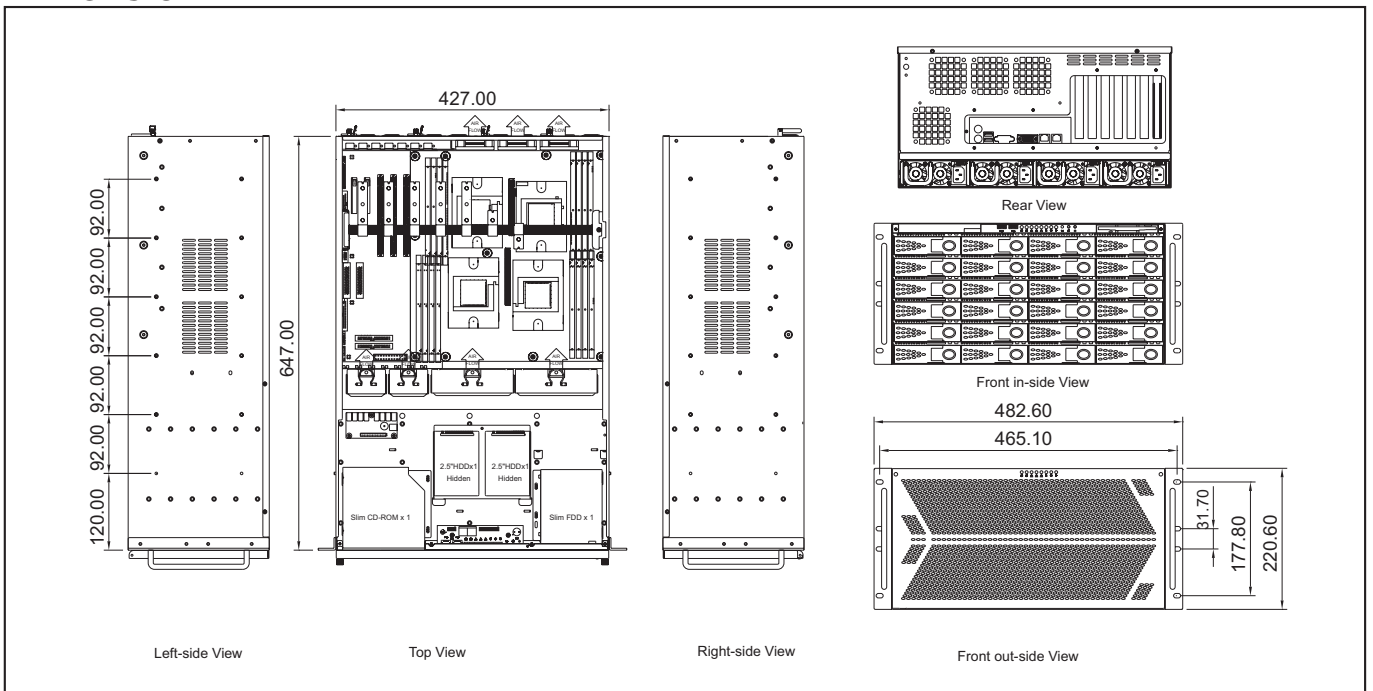

GHI-591

5U Rackmount Chassis



19" Rackmount

Specifications

- **EIA RS-310C 19" Rackmount Standard**
- **Construction:** Heavy Duty Cold Rolled Electroplated Steel
- **Color:** Black (Standard), Beige or Custom
- **System Boards:** Pentium 4, Dual Xeon, Athlon 64, Dual Opteron, Quad Opteron
- **Supports EATX M/B (Max. to 13" x 16") With Removable Drawer**
- **Drive Capacity:** 1x 5.25" , 1x Slim FDD & 22x 3.5" Hot Swappable Trays & 1x 2.5" HDD & 3x 3.5" HDD (Optional)
- **Drive Interface:** PATA, SATA, SCSI320 , Multilane SATA or SAS
- **Power Supply (Optional):** 1U Redundant up to 1650W ATX P/S (Rear Installation) Max. Depth 300mm
- **Cooling:** 3x (120mm = 90CFM ea.) Fans & 3x (80mm= 42.5CFM ea.) Fans
- **Front Door:** Single Door With 2 Thumbscrews (Removable)
- **Connector Port (Front):** 2x USB Ports
- **Thermal Management Card:** GHA-CO04
- **Indicators:** LEDs for Power ON/OFF, HDD Activity, Fan, Temperature, LAN
- **Flexible Hold Down Bar Designed**
- **Switch:** Power ON/OFF Momentary (Dimple), System Reset, Buzzer Reset
- **Dimensions (W x H x D):** 483 x 222 x 650mm (19" x 8.7" x 25.6")
- **Cuft:** 6.8
- **GW:** 33.5 kgs / 73.9 lbs
- **Carton Size (cm):** 85.5 x 37 x 61 (33.7" x 14.6" x 24")
- **Humidity:** 5% - 95% Non-condensing

Dimension

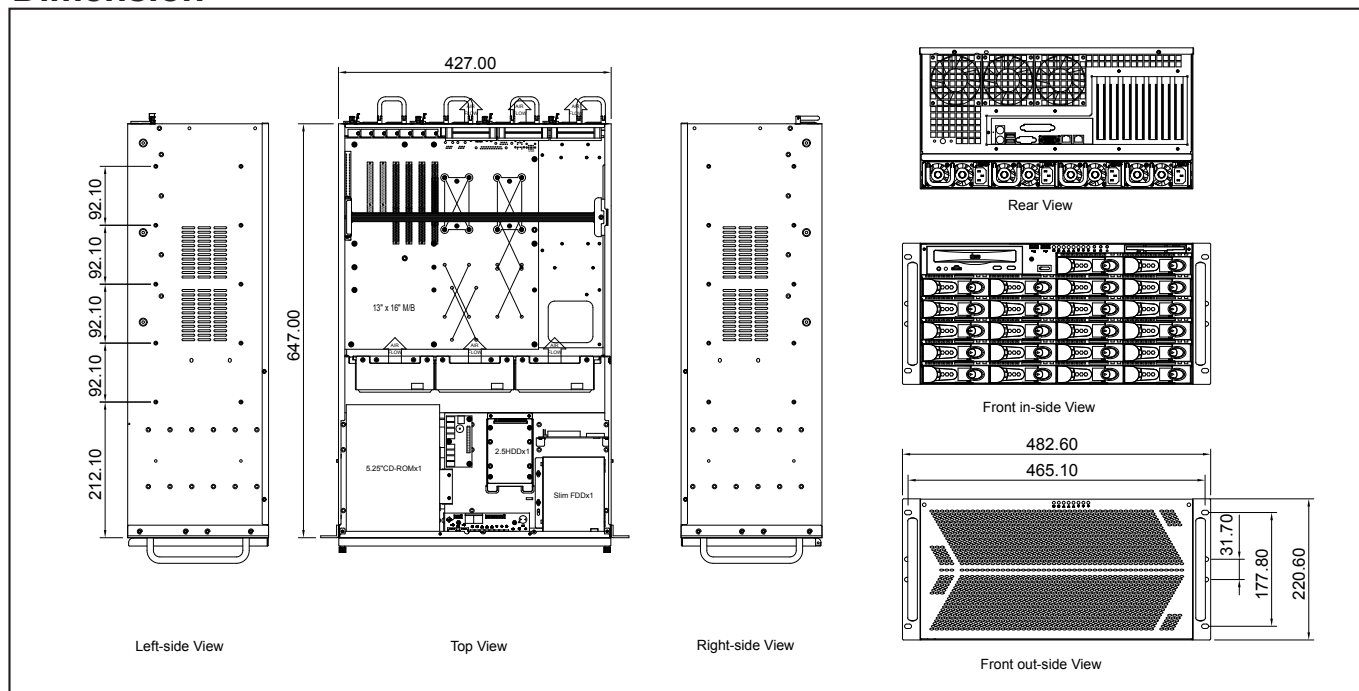

GH-600ATXR/620SR

6U Rackmount Chassis



19" Rackmount

Specifications

- **EIA RS-310C 19" Rackmount Standard**
- **Construction:** Heavy Duty Cold Rolled Electroplated Steel
- **Color:** Black (Standard), Beige or Custom
- **System Boards:** Dual Xeon, Pentium 4, Dual Pentium III
- **Support EATX M/B (Max. to 13" x 16") SSI EEB 3.0 With Removable Drawer (600ATX)**
- **Support 20-slot Passive Backplane With Removable Drawer (620SR)**
- **Drive Capacity:** 7x 5.25" & 1x 3.5"
- **Power Supply (Optional):** PS/2 Size Single up to 700W or Horizontal Redundant up to 550W or Mini Redundant up to 500W ATX P/S(Rear Installation)
- **Cooling:** Hot Swappable 4x (90mm = 51CFM ea.) Fans
- **Front Door:** Single Door With Keylock
- **Air Filter:** Inside Front Door (Washable)
- **Thermal Management Card:** GHA-CO01
- **Indicators:** LEDs for Power ON/OFF, HDD Activity, Fan, Temperature
- **Flexible Hold Down Bar Designed**
- **Switch:** Power ON/OFF Momentary or AT (Pushbutton), System Reset, Buzzer Reset
- **Dimensions (W x H x D):** 483 x 267 x 671mm (19" x 10.5" x 26.4")
- **Cuft:** 7.7
- **GW:** 29.0 kgs / 64.0 lbs
- **Carton Size (cm):** 61 x 41.8 x 85.5 (24" x 16.5" x 33.7")
- **Humidity:** 5% - 95% Non-condensing

Dimension

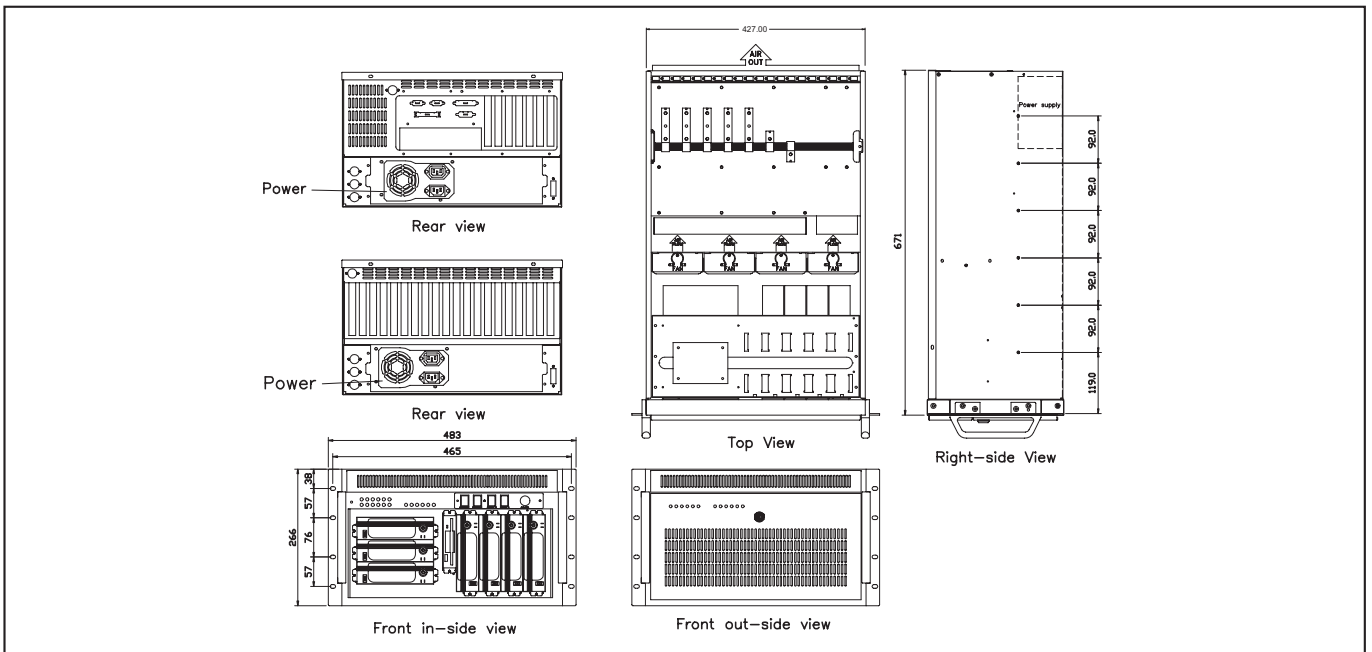

GHI-611ATXR/611SR

6U Rackmount Chassis

19" Rackmount



Specifications

- EIA RS-310C 19" Rackmount Standard
- Construction: Heavy Duty Cold Rolled Electroplated Steel
- Color: Black (Standard), Beige or Custom
- Support EATX M/B (Max. to 12" x 16") With Removable Drawer (GHI-611SATXR)
- Support 20-slot Passive Backplane With Removable Drawer (GHI-611SR)
- Drive Capacity: 4x 5.25" & 2x 3.5" HDD
- Power Supply (Optional): PS/2 Size Single up to 700W or Horizontal Redundant up to 550W or Mini Redundant up to 500W ATX P/S (Rear Installation)
- Cooling: Hot Swappable 4x (90mm = 51CFM ea.) Fans
- Connector Port (Front): 2 X USB Ports (Optional)
- Front Door: Single Door With 1 Thumb Twist Keylock
- Air Filter: Inside Front Door (Washable)
- Thermal Management Card: GHA-CO04
- Indicators: LEDs for Power ON/OFF, HDD Activity, Fan, Temperature
- Flexible Hold Down Bar Designed
- Switch: Power ON/OFF Momentary or AT (Pushbutton), System Reset, Buzzer Reset
- Dimensions (W x H x D): 483 x 267 x 463mm (19" x 10.5" x 18.2")
- Cuff: 5.8
- GW: 25.3 kgs / 55.8 lbs
- Carton Size (cm): 61 x 41.8 x 64.7 (24" x 16.5" x 25.5")
- Humidity: 5% - 95% Non-condensing

Dimension

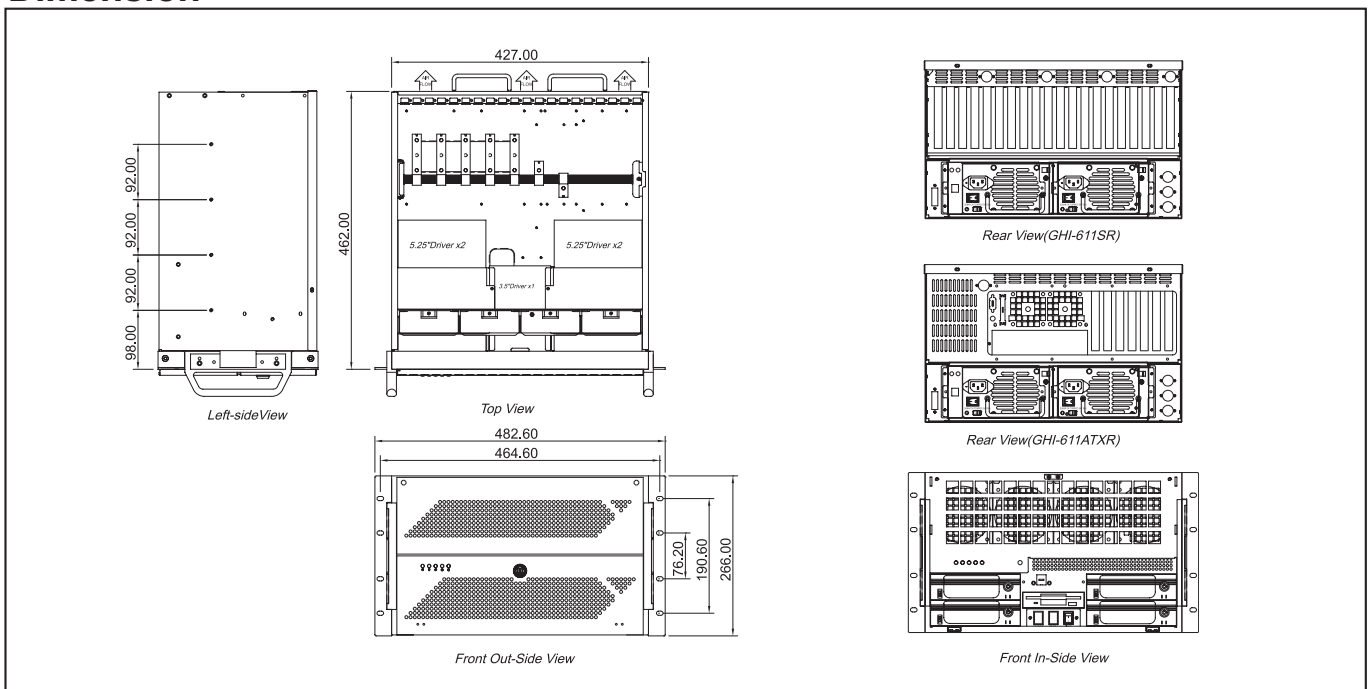

GHI-690

6U Rackmount Chassis



Specifications

- **EIA RS-310C 19" Rackmount Standard**
- **Construction:** Heavy Duty Cold Rolled Electroplated Steel
- **Color:** Black (Standard), Beige or Custom
- **System Boards:** Pentium 4, Dual Xeon, Athlon 64, Dual Opteron, Quad Opteron
- **Supports EATX M/B (Max. to 13" x 16") With Removable Drawer**
- **Drive Capacity:** 36 x 3.5" Swappable HDD
- **Drive Interface:** SATA, SCSI320, Multilane SATA or SAS
- **Power Supply (Optional):** 1U Redundant up to 1650W ATX P/S (Rear Installation) Max. Depth 300mm
- **Cooling:** 2x (120mm = 108CFM ea.) & 2x (60mm = 23.5CFM ea.) & 3x (60mm = 23.5CFM ea.) Hot Swappable Fans
- **Front Door:** Double Horizontal Doors With 2 Thumbscrews
- **Thermal Management Card:** GHA-CO08
- **Indicators:** LEDs for Power ON/OFF, HDD Power/Activity, Fan, Temperature, LAN
- **Flexible Hold Down Bar Designed**
- **Switch:** Power ON/OFF Momentary (Dimple), System Reset, Buzzer Reset
- **Dimensions (W x H x D):** 483 x 265 x 666mm (19" x 10.4" x 26.2")
- **Cuft:** 7.7
- **GW:** 36.7 kgs / 80.9 lbs
- **Carton Size (cm):** 61 x 41.8 x 85.5 (24" x 16.5" x 33.7")
- **Humidity:** 5% - 95% Non-condensing

Dimension

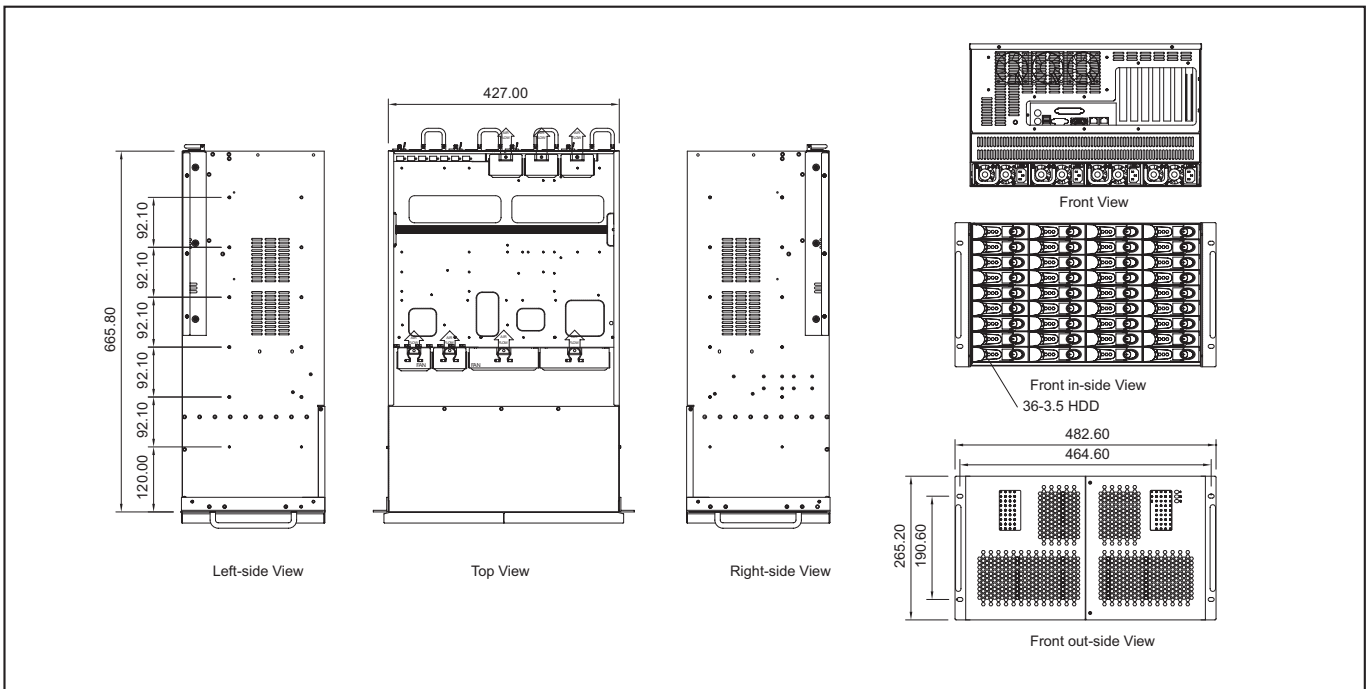

GHI-691

6U Rackmount Chassis



Specifications

- **EIA RS-310C 19" Rackmount Standard**
- **Construction:** Heavy Duty Cold Rolled Electroplated Steel
- **Color:** Black (Standard), Beige or Custom
- **System Boards:** Pentium 4, Dual Xeon, Athlon 64, Dual Opteron, Quad Opteron
- **Supports EATX M/B (Max. to 13" x 16") With Removable Drawer**
- **Drive Capacity:** 1x Slim CD-ROM, 1x Slim FDD & 32 x 3.5" Swappable HDD & 4x3.5" Hot Swappable HDD on Rear Side (Optional)
- **Drive Interface:** PATA, SATA, SCSI320, Multilane SATA or SAS
- **Power Supply (Optional):** 1U Redundant up to 1650W ATX P/S (Rear Installation) Max. Depth 300mm
- **Cooling:** 2x (120mm = 108CFM ea.) & 2x (60mm = 23.5CFM ea.) & 3x (60mm = 23.5CFM ea.) Hot Swappable Fans
- **Front Door:** Single Door With 2 Thumbscrews (Removable)
- **Connector Port (Front):** 2x USB Ports
- **Thermal Management Card:** GHA-CO04
- **Indicators:** LEDs for Power ON/OFF, HDD Power/Activity, Fan, Temperature, LAN
- **Flexible Hold Down Bar Designed**
- **Switch:** Power ON/OFF Momentary (Dimple), System Reset, Buzzer Reset
- **Dimensions (W x H x D):** 483 x 265 x 666mm (19" x 10.4" x 26.2")
- **Cuft:** 7.7
- **GW:** 38.3 kgs / 84.5 lbs
- **Carton Size (cm):** 61 x 41.8 x 85.5 (24" x 16.5" x 33.7")
- **Humidity:** 5% - 95% Non-condensing

Dimension

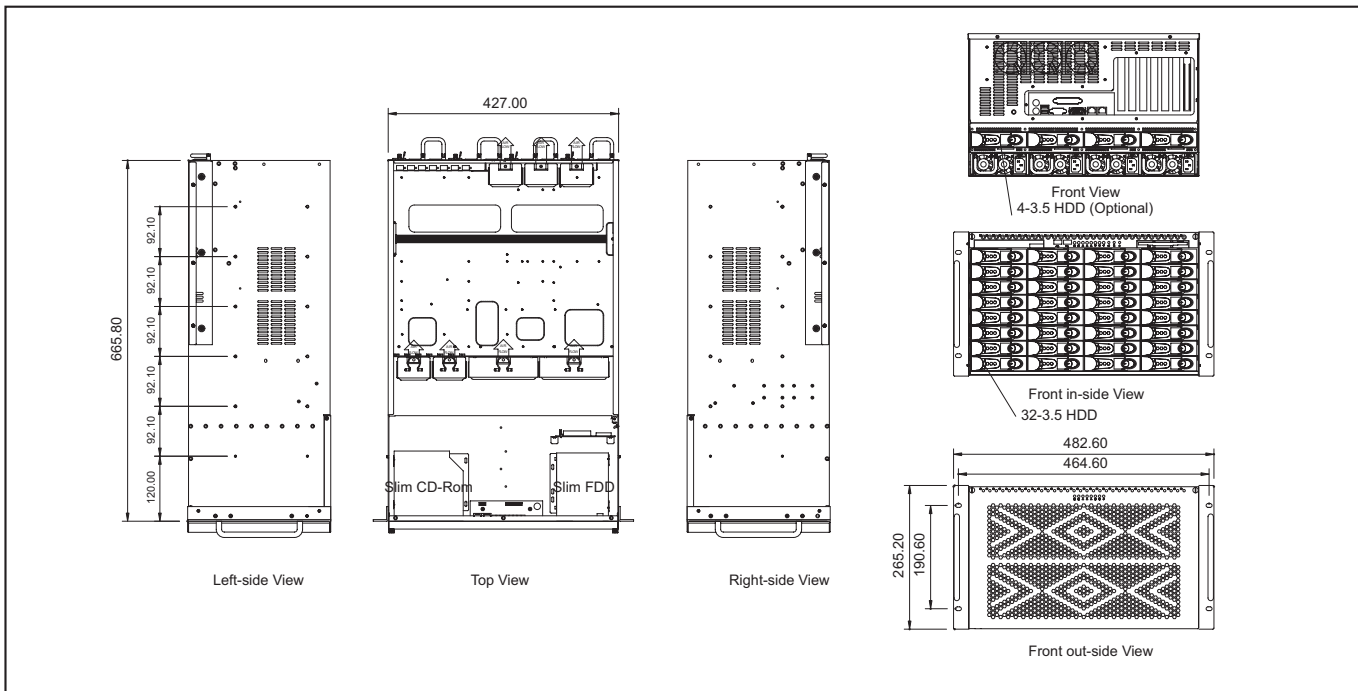

GHI-791

7U Rackmount Chassis



Specifications

- **EIA RS-310C 19" Rackmount Standard**
- **Construction:** Heavy Duty Cold Rolled Electroplated Steel
- **Color:** Black (Standard), Beige or Custom
- **System Boards:** Pentium 4, Dual Xeon, Athlon 64, Dual Opteron
- **Support EATX M/B (Max. to 13" x 16") SSI EEB 3.0**
- **Drive Capacity:** 1x Slim CD-ROM & 1x Slim FDD & 36x 3.5" Swappable Trays
- **Drive Interface:** SATA, SCSI320, Multilane SATA or SAS
- **Power Supply(Optional):** 1U Redundant up to 1650W ATX P/S (Rear Installation) Max. Depth 300mm
- **Cooling: (GHI-791-1):** 2x (80mm = 42.5CFM ea.) & 4x (90mm = 51.0CFM ea.) & 2x (120mm = 40.2CFM ea.) Fans
- **Cooling: (GHI-791-2):** 3x (60mm = 23.5CFM ea.) & 4x (90mm = 51.0CFM ea.) & 3x (120mm = 90.0CFM ea.) Fans
- **Front Door:** Single Door With 2 Thumbscrews
- **Connector Port (Front):** 2x USB Ports
- **Thermal Management Card:** GHA-CO04
- **Indicators:** LEDs for Power ON/OFF, HDD Activity, Fan, Temperature, LAN
- **Flexible Hold Down Bar Designed**
- **Switch:** Power ON/OFF Momentary (Rocker), System Reset, Buzzer Reset
- **Dimensions (W x H x D):** 483 x 311 x 666mm (19" x 12.24" x 26.2")
- **Cuft:** 9.1
- **GW:** 40.9 kgs / 90.2 lbs
- **Carton Size(cm):** 85 x 49.4 x 61.5 (33.5" x 19.5" x 26.2")
- **Humidity:** 5% - 95% Non-condensing

Dimension

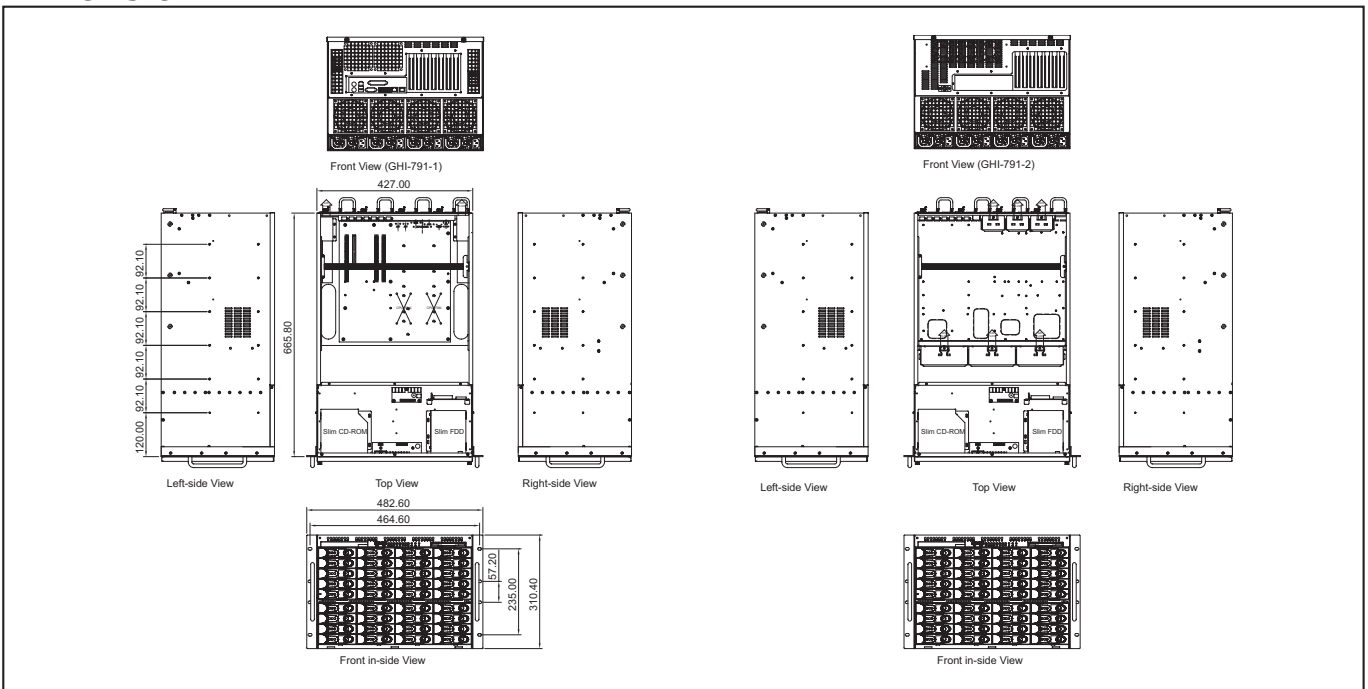

GH-800ATXR/820SR

8U Rackmount Chassis

19" Rackmount



Specifications

- **EIA RS-310C 19" Rackmount Standard**
- **Construction:** Heavy Duty Cold Rolled Electroplated Steel
- **Color:** Black (Standard), Beige or Custom
- **System Boards:** Dual Xeon, Pentium 4, AMD 64, Dual Opteron, Quad Opteron
- **Support EATX M/B (Max. to 13" x 16") SSI EEB 3.0 With Removable Drawer (800ATXR)**
- **Support 20-slot Passive Backplane With Removable Drawer (820SR)**
- **Drive Capacity:** 7x 5.25" & 1x 3.5"
- **Power Supply (Optional):** PS/2 Size Single up to 700W or Vertical Redundant up to 550W or Mini Redundant up to 500W ATX P/S (Rear Installation)
- **Cooling:** Hot Swappable 4x(90mm = 51CFM ea.) Fans & 1x (120mm = 108CFM ea.) Fan With Removable Air Filter
- **Front Door:** Single Door With Keylock
- **Air Filter:** Inside Front Door (Washable)
- **Thermal Management Card:** GHA-CO01
- **Indicators:** LEDs for Power ON/OFF, HDD Active, Fan, Temperature
- **Flexible Hold Down Bar Designed**
- **Switch:** Power ON/OFF Momentary (Pushbutton), System Reset, Buzzer Reset
- **Dimensions (W x H x D):** 483 x 356 x 510mm (19" x 16.5" x 18.2")
- **Cuft:** 7.4
- **GW:** 30.5 kgs / 67.3 lbs
- **Carton Size(cm):** 60.5 x 50.5 x 68.5(23.8"x19.9"x27")
- **Humidity:** 5% - 95% Non-condensing

Dimension

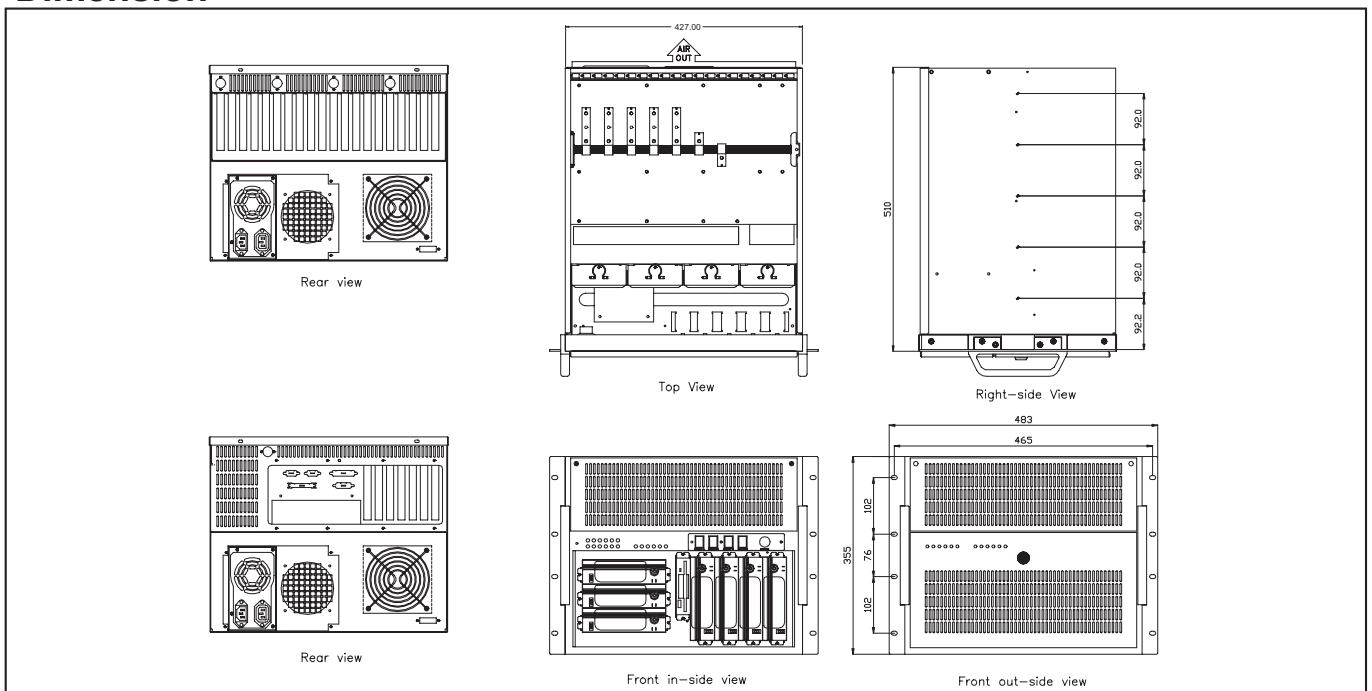

GHI-891

8U Rackmount Chassis

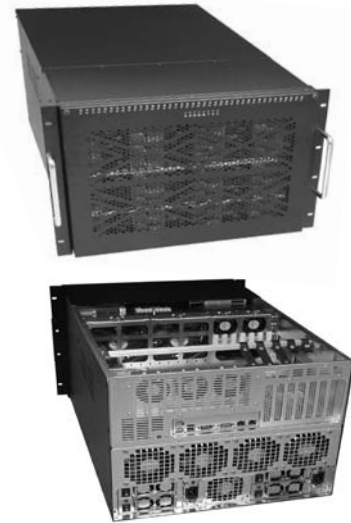
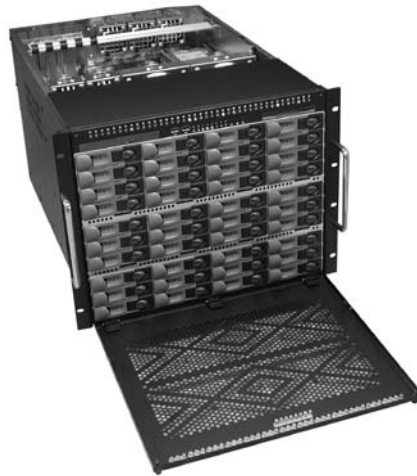

Specifications

- **EIA RS-310C 19" Rackmount Standard**
- **Construction:** Heavy Duty Cold Rolled Electroplated Steel
- **Color:** Black (Standard), Beige or Custom
- **System Boards:** Pentium 4, Dual Xeon, Athlon 64, Dual Opteron
- **Support EATX M/B (Max. to 13" x 16") SSI EEB 3.0**
- **Drive Capacity:** (GHI-891-1): 1x Slim CD-ROM & 1x Slim FDD & 40x 3.5" Swappable Trays
- **Drive Capacity:** (GHI-891-2): 1x Slim CD-ROM & 1x Slim FDD & 40x 3.5" Swappable Trays & 1x 5.25" CD-ROM & 2x 3.5" HDD
- **Drive Capacity:** (GHI-891-3): 1x Slim CD-ROM & 1x Slim FDD & 44x 3.5" Swappable Trays
- **Drive Interface:** SATA, SCSI320, Multilane SATA or SAS
- **Power Supply(Optional):** 2U Single up to 700W or 2U Redundant up to 600W or N+1 up to 950W or 1U Redundant up to 1650W ATX P/S (Rear Installation) Max. Depth 300mm
- **Cooling:** (GHI-891-1): 5x(60mm = 23.5CFM ea.) & 1x (80mm = 42.5CFM ea.) & 4x (90mm = 51.0CFM ea.) & 5x (120mm = 90.0CFM ea.) Fan
- **Cooling:** (GHI-891-2): 5x(60mm = 23.5CFM ea.) & 4x (80mm = 42.5CFM ea.) & 2x (90mm = 51.0CFM ea.) & 5x (120mm = 90.0CFM ea.) Fan
- **Cooling:** (GHI-891-3): 8x (40mm = 7.0CFM ea.) & 5x (60mm = 23.5CFM ea.) & 1x (80mm = 42.5CFM ea.) & 5x (120mm = 90.0CFM ea.) Fan
- **Front Door:** Single Door With 2 Thumbscrews (Removable)
- **Connector Port (Front):** 2x USB Ports
- **Thermal Management Card:** GHA-CO04
- **Indicators:** LEDs for Power ON/OFF, HDD Activity, Fan, Temperature, LAN
- **Flexible Hold Down Bar Designed**
- **Switch:** Power ON/OFF Momentary (Pushbutton), System Reset, Buzzer Reset
- **Dimensions (W x H x D):** 483 x 354 x 666mm (19" x 13.9" x 26.2")
- **Cuft:** 9.1
- **GW:** 40.9 kgs / 90.2 lbs
- **Carton Size(cm):** 85 x 49.4 x 61.5 (33.5" x 19.5" x 26.2")
- **Humidity:** 5% - 95% Non-condensing

Dimension

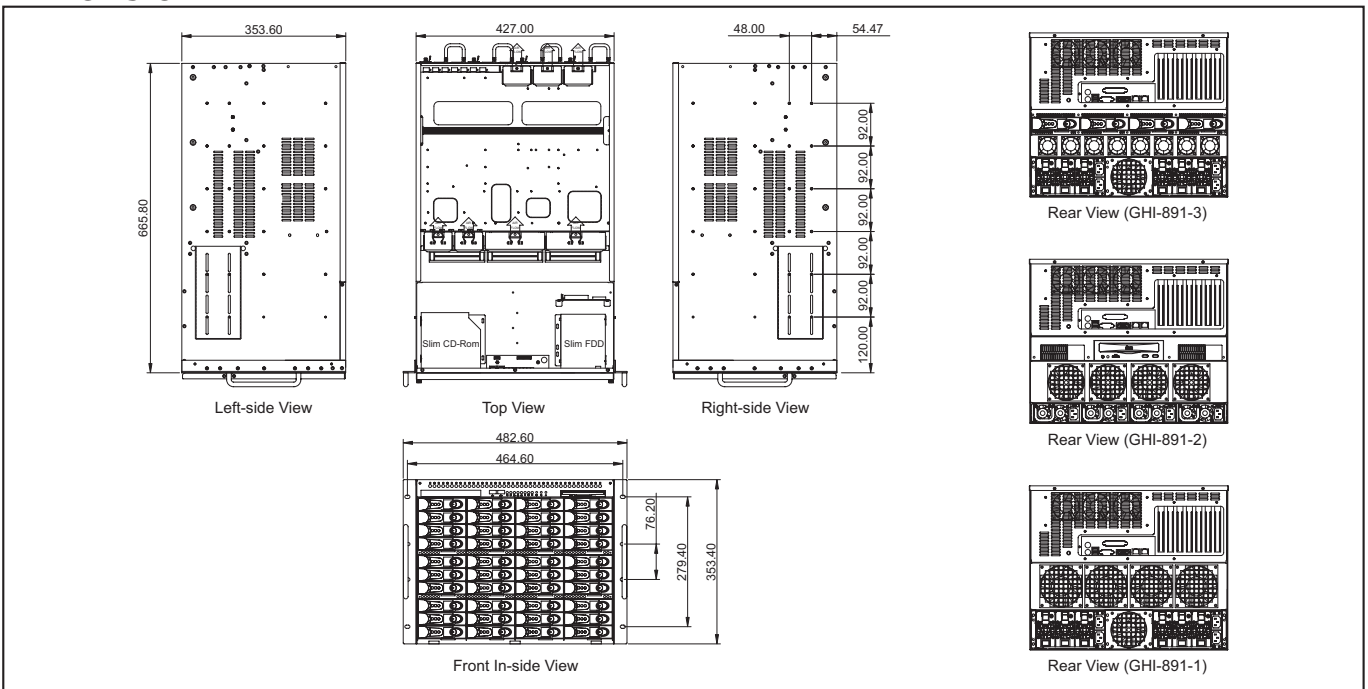

GHI-P01

8U Rackmount Chassis

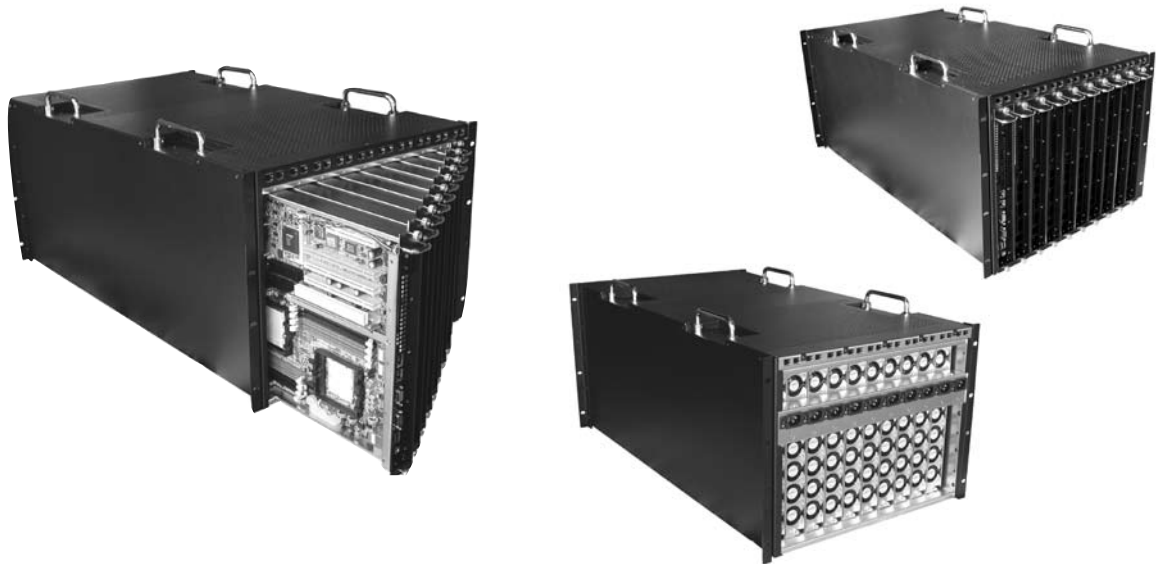

Specifications

- **Meet 19" 8U Height Rack-mount Enclosure with 10 x 1U Nodes**
- **Constructions:** Heavy Duty Cold Rolled Electroplated Steel
- **Color:** Black (Standard), Beige or Custom
- **System Boards:** Dual Xeon, Dual Opteron, Dual Athlon, Pentium 4 800FSB, Dual Pentium III
- **Support ATX M/B (Max. to 12" x 13") With Removable Drawer**
- **Drive Capacity:** 2x 3.5"HDD Per Node.(Total 10 nodes = 20x HDD)
- **Power Supply (Optional):** 1U Single up to 460W ATX P/S Per Node (Mid Installation) Max. Depth 300mm
- **Cooling:** 8x (40x 28mm = 15.3CFM ea.) Fans & 1x (40x 20mm = 8CFM ea.) Fan Per Node
- **Expansion Slots:** 1x Horizontal PCI Slot Per Node.
- **Additional Expansion:** 10 x RJ45 Patch Panel or 20 x RJ45 Patch Panel(Optional)
- **Indicators:** LEDs for Power ON/OFF Momentary (Square Pushbutton), HDD Activity
- **Switch:** Power ON/OFF, System Reset
- **Dimensions(WxHxD):** 483 x 355 x 830mm (19" x 14" x 32.7")
- **Cuft:** 14
- **GW:** 72 kgs / 158.8 lb
- **Carton Size(cm):** 105.5 x 70.5 x 53.6 (41.5" x 27.6" x 21.1")
- **Humidity:** 5% - 95% Non-condensing

Dimension

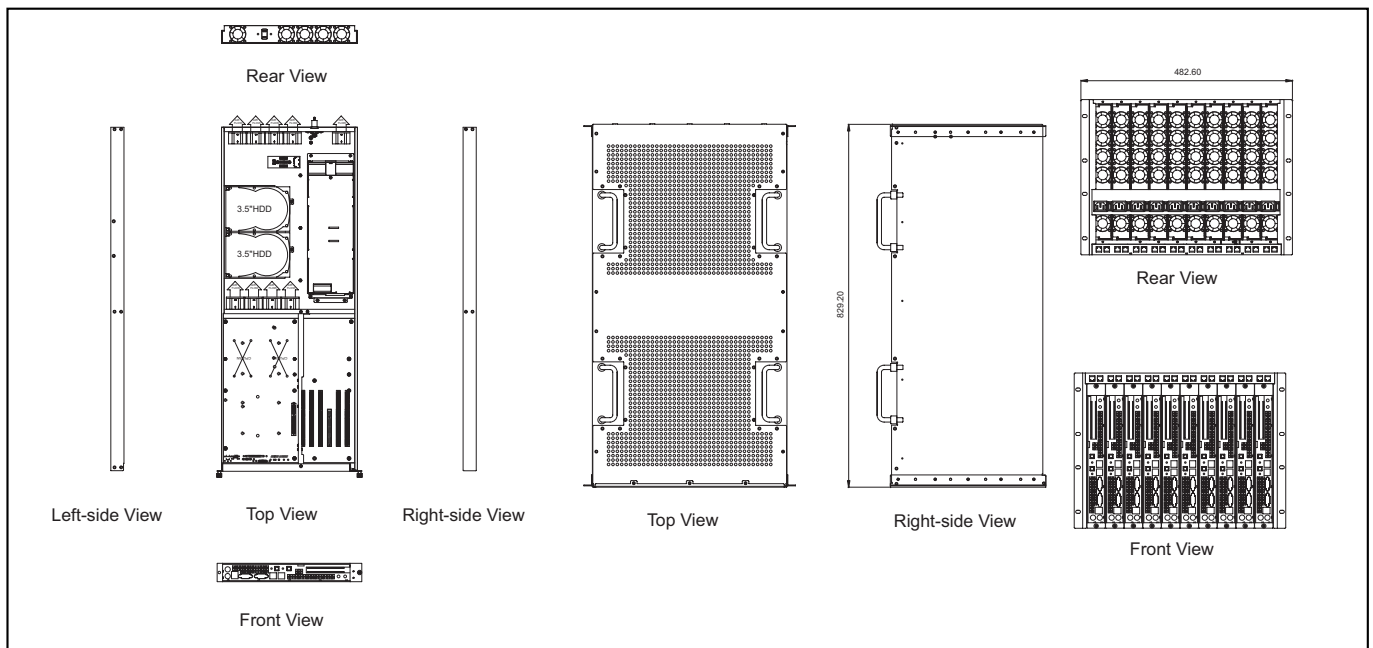

GHB-B04

6U-1/4 Rackmount Chassis



Specifications

- **Mounting:** Rack Mount
- **Construction:** Heavy Duty Cold Rolled Electroplated Steel
- **Color:** Black (Standard), Beige or Custom
- **Support 4-slot Passive Backplane**
- **Drive Capacity:** 1x3.5" & 1x3.5"HDD
- **Power Supply(Optional):** Special Size 150W P/S (Rear Installation) Depth 190mm
- **Cooling:** Hot Swappable 1x(92mm = 51CFM ea.) Fan
- **Air Filter:** Inside Front Panel (Washable)
- **Connector Port(Front):** 2 x USB Ports
- **Indicators:** LEDs for Power ON/OFF, HDD Activity
- **Switch:** Power ON/OFF, System Reset
- **Dimensions (WxHxD):** 110 x 267 x 451mm (4.3"x10.5"x17.8")
- **Cuft:** 1.5
- **GW:** 7.0 kgs / 15.4 lbs
- **Carton Size(cm):** 57 x 20 x 36.4(22.4" x 7.9" x 14.3")
- **Humidity:** 5% - 95% Non-condensing

Dimension

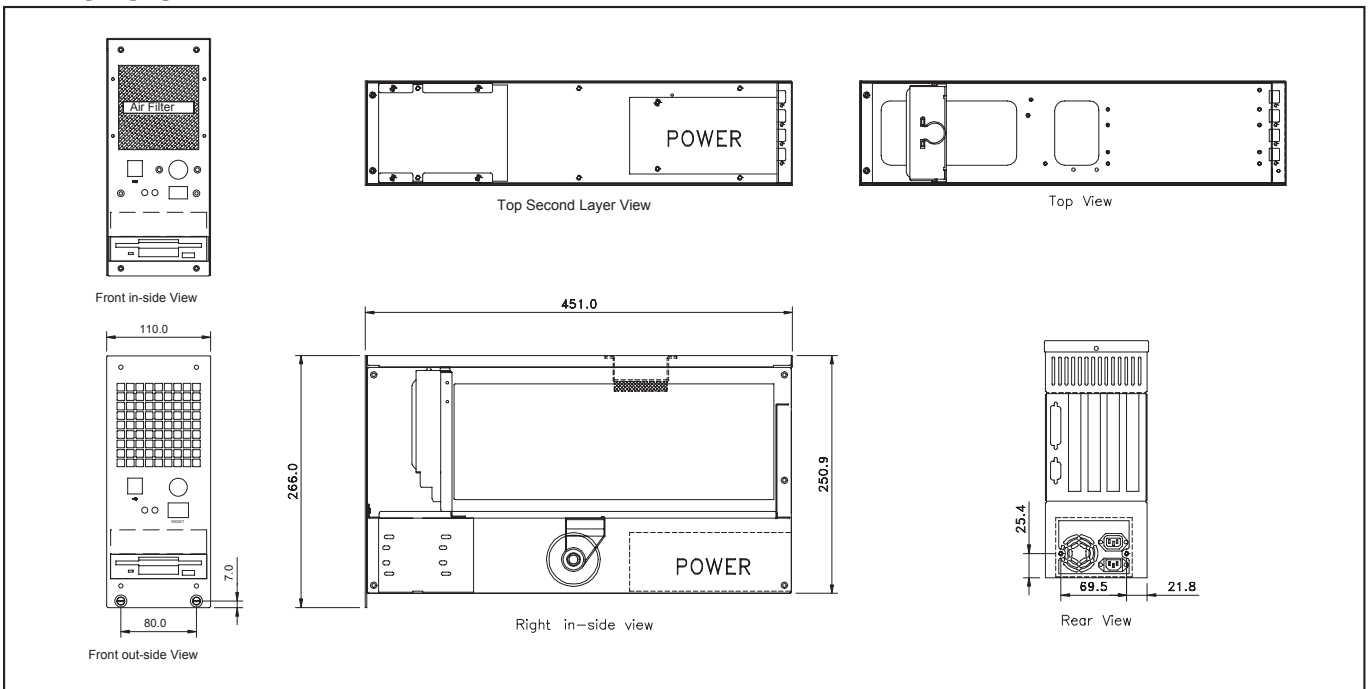

GHB-B05

2-Slot Micro Box Chassis



GHB-B05-R (Rackmount Kits)

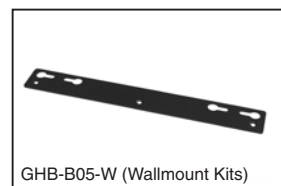

GHB-B05-W (Wallmount Kits)

Specifications

- **Mounting:** Rack Mount or Wall Mount or Desktop
- **Construction:** Heavy Duty Cold Rolled Electroplated Steel
- **Color:** Black (Standard), Beige or Custom
- **Support Mini-ITX M/B (Max. to 6.7" x 6.7")**
- **Drive Capacity**
 - B05-1: 1xSlim CD-ROM & 4x2.5"HDD
 - B05-2: 1xSlim CD-ROM& 1x3.5"HDD&2x2.5"HDD
 - B05-3: 8x2.5"HDD
 - B05-4: 2x2.5"HDD & 1x3.5"HDD
 - B05-5: 2x2.5"HDD & 2x3.5"HDD
- **Power Supply(Optional):** Flex ATX up to 250W P/S (Rear Installation) Max. Depth 150mm
- **Cooling:** 1x(60mm = 23.5CFM ea.) Fan
- **Expansion Slots:** 2 PCI Slot
- **Riser Card:** GHP-PCI106H (Optional)
- **Connector Port (Front):** 2x USB Ports
- **Indicators:** LEDs for Power ON/OFF, HDD Activity
- **Switch:** Power ON/OFF, System Reset
- **Dimensions (W x H x D):** 280 x 77 x 268mm (11" x 3" x 10.6")
- **Cuft:** 0.8
- **GW:** 3.4 kgs / 7.5 lbs
- **Carton Size(cm):**37.3 x 17.5 x 36.3(14.7" x 6.9" x 14.3")
- **Humidity:** 5% - 95% Non-condensing

Dimension

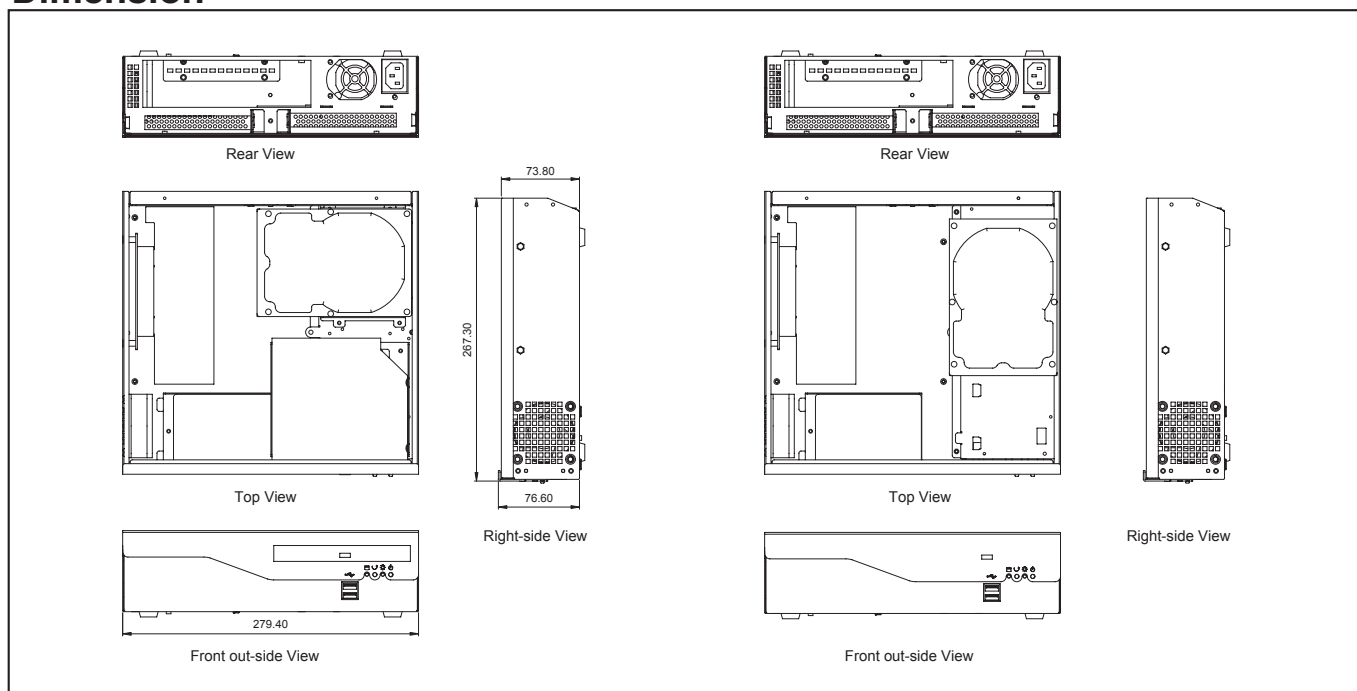

GHB-B08

6U-1/2 Rackmount Chassis



19" Rackmount

Specifications

- **Mounting:** Rack Mount
- **Construction:** Heavy Duty Cold Rolled Electroplated Steel
- **Color:** Black (Standard), Beige or Custom
- **Support 8-slot Passive Backplane**
- **Drive Capacity:** 1x 5.25" & 1x 3.5" & 1x 3.5"HDD
- **Power Supply(Optional):** PS/2 Size Single 250~400W or Redundant 230~250W P/S(Rear Installation)
- **Connector Port (Front):** 1x PS/2 Port & 2x USB Port
- **Cooling:** Hot Swappable 2x (90mm = 51CFM ea.) Fans
- **Air Filter:** Inside Front Panel (Washable)
- **Indicators:** LEDs for Power ON/OFF, HDD Activity
- **Switch:** Power ON/OFF, System Reset
- **Dimensions (W x H x D):** 220 x 266 x 451mm (4.3" x 10.5" x 17.8")
- **Cuft:** 2.3
- **GW:** 9.6 kgs / 21.2 lbs
- **Carton Size(cm):** 57.0 x 31.2 x 36.4 (22.4" x 12.3" x 14.3")
- **Humidity:** 5% - 95% Non-condensing

Dimension

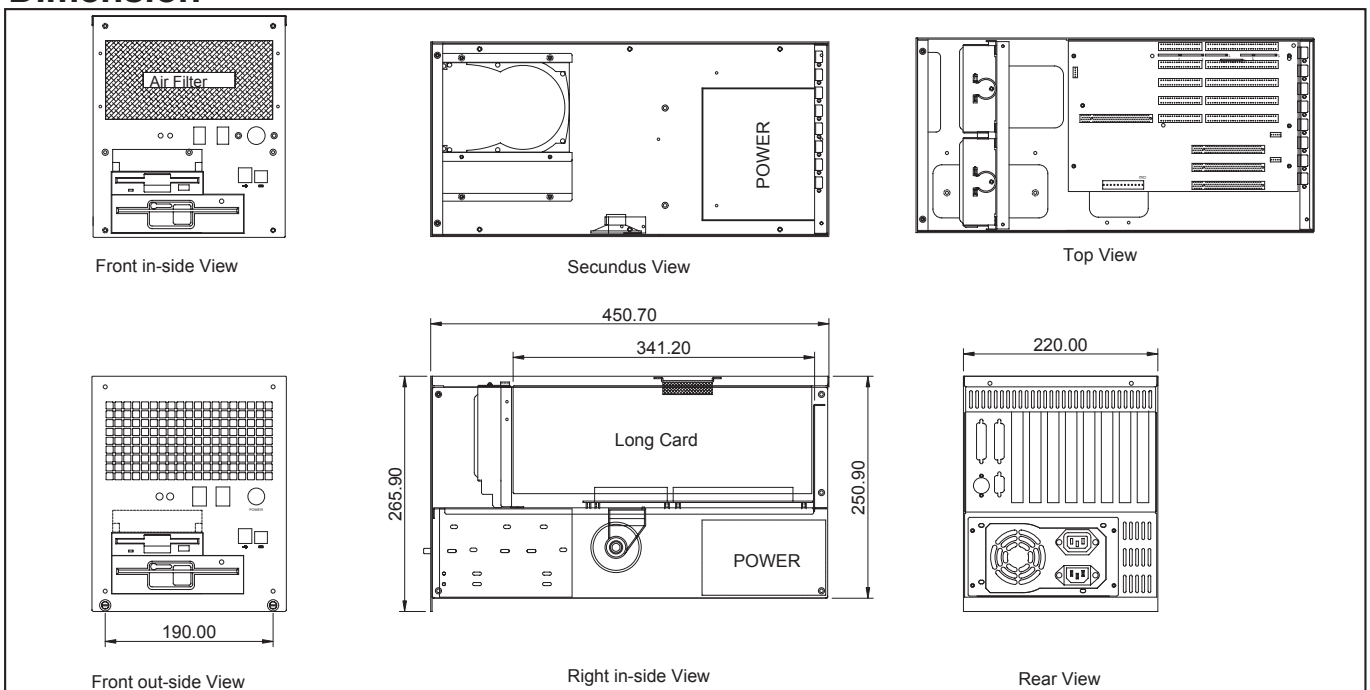

GHB-030

3-slot Micro Box Chassis



Specifications

- **Mounting:** Desktop or Rack Mount
- **Construction:** Heavy Duty Cold Rolled Electroplated Steel
- **Color:** Black (Standard), Beige or Custom
- **Supports 3-slot Passive Backplane**
- **Drive Capacity:** 1x 3.5"HDD
- **Power Supply (Optional):** 1U Single up to 350W ATX P/S (Rear Installation)
- **Cooling:** 1x (92mm = 51CFM) Fan
- **Connertor Port (Front):** 2x USB Ports
- **Air Filter:** Inside Front Panel (Washable)
- **Indicators:** LEDs for Power ON/OFF, HDD Activity
- **Switch:** Power ON/OFF, System Reset
- **Dimensions (W x H x D):** 110 x 221.5 x 250mm (4.3" x 8.7" x 9.8")
- **Cuft:** 0.8
- **GW:** 4.0 kgs / 8.8 lbs
- **Carton Size(cm):** 36.8 x 20.7 x 30.8 (14.5" x 8.2" x 12.1")
- **Humidity:** 5% - 95% Non-condensing

Dimension

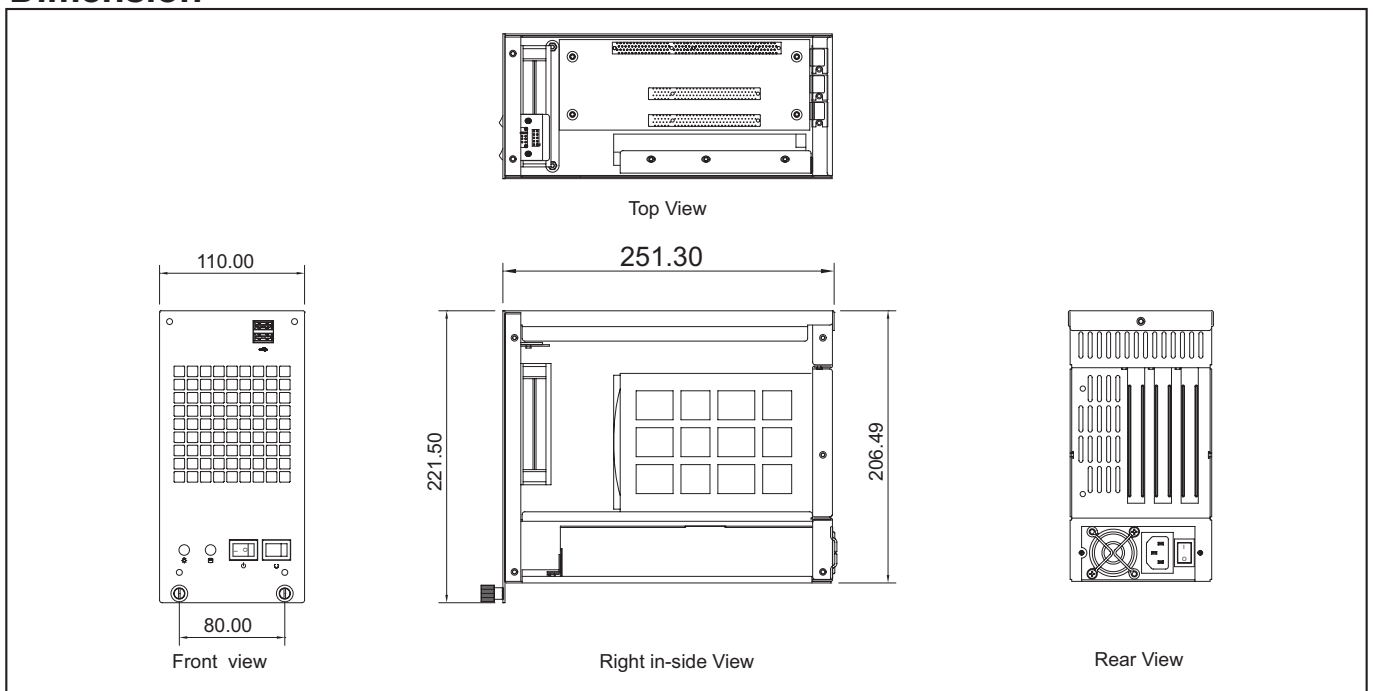

GHB-042

4-slot Micro Box Chassis



Specifications

- **Mounting:** Desktop or Wall Mount
- **Construction:** Heavy Duty Cold Rolled Electroplated Steel
- **Color:** Black (Standard), Beige or Custom
- **Supports 4-slot Passive Backplane**
- **Drive Capacity:** 1x 3.5" & 1x 3.5"HDD
- **Power Supply (Optional):** 1U Single up to 300W ATX P/S (Rear Installation) Max. Depth 205mm
- **Connector Port (Front):** 2x USB Ports
- **Cooling:** Hot Swappable 1x (92mm = 51CFM) Fan
- **Air Filter:** Inside Front Panel (Washable)
- **Indicators:** LEDs for Power ON/OFF, HDD Activity
- **Switch:** Power ON/OFF, System Reset
- **Dimensions(WxHxD):** 110x251x449mm(4.3"x9.9"x 17.7")
- **Cuft:** 1.5
- **GW:** 6.3 kgs / 13.9 lbs
- **Carton Size(cm):** 57 x 20 x 36.4 (22.4" x 7.9" x 14.3")
- **Humidity:** 5% - 95% Non-condensing

Dimension

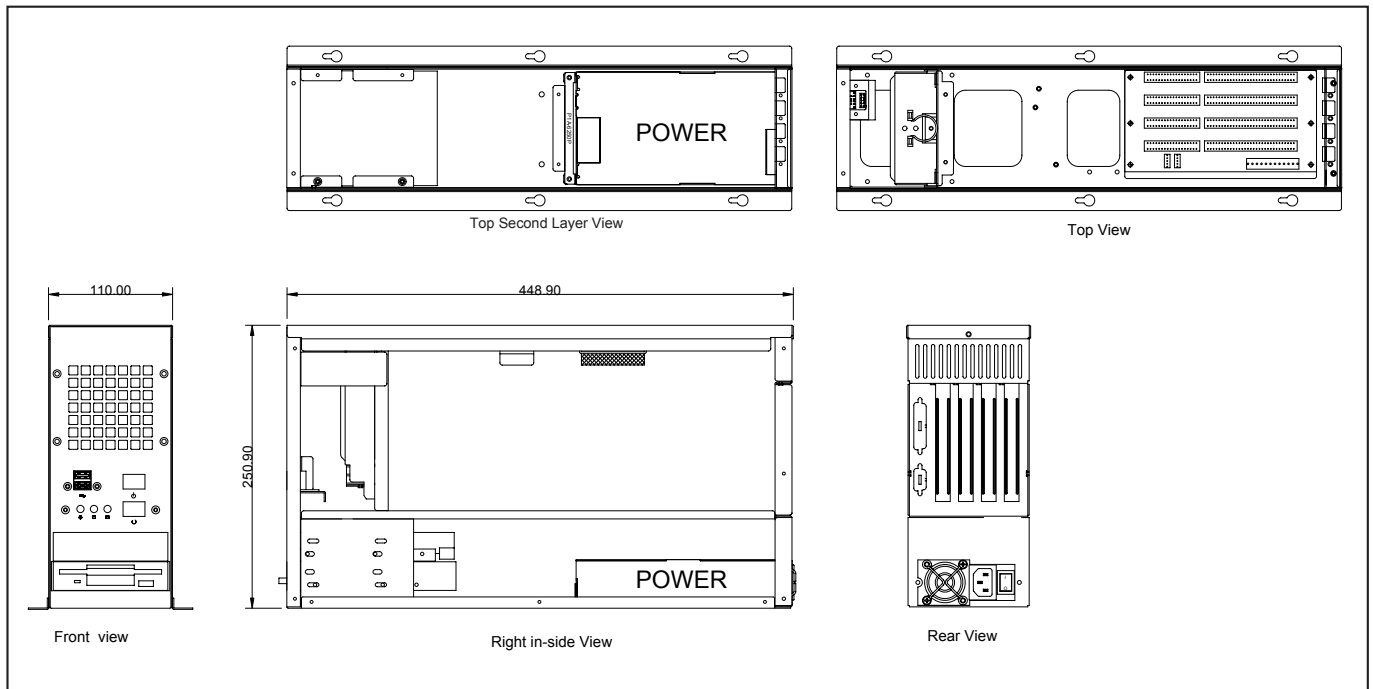

GHB-043

4-slot Micro Box Chassis



Specifications

- **Mounting:** Desktop or Wall Mount
- **Construction:** Heavy Duty Cold Rolled Electroplated Steel
- **Color:** Black (Standard), Beige or Custom
- **Supports 4-slot Passive Backplane**
- **Drive Capacity:** 1x 3.5" HDD & 1x 3.5" FDD & 1x 5.25" Slim CD-ROM
- **Power Supply (Optional):** 1U Single up to 300W ATX P/S
Depth 190mm
- **Connertor Port (Front):** 2xUSB Ports
- **Cooling:** 1x (92mm = 51CFM) Hot Swappable Fan & 1x (60mm = 23.5CFM) Fan
- **Air Filter:** Inside Front Panel (Washable)
- **Indicators:** LEDs for Power ON/OFF, HDD Activity
- **Switch:** Power ON/OFF, System Reset
- **Dimensions (W x H x D):** 160 x 220 x 260mm (6.3" x 8.6" x 10.2")
- **Cuft:** 0.9
- **GW:** 5.0kgs / 11lbs
- **Carton Size(cm):** 23 x 29 x 36.5 (9.1" x 11.4" x 14.4")
- **Humidity:** 5% - 95% Non-condensing

Dimension

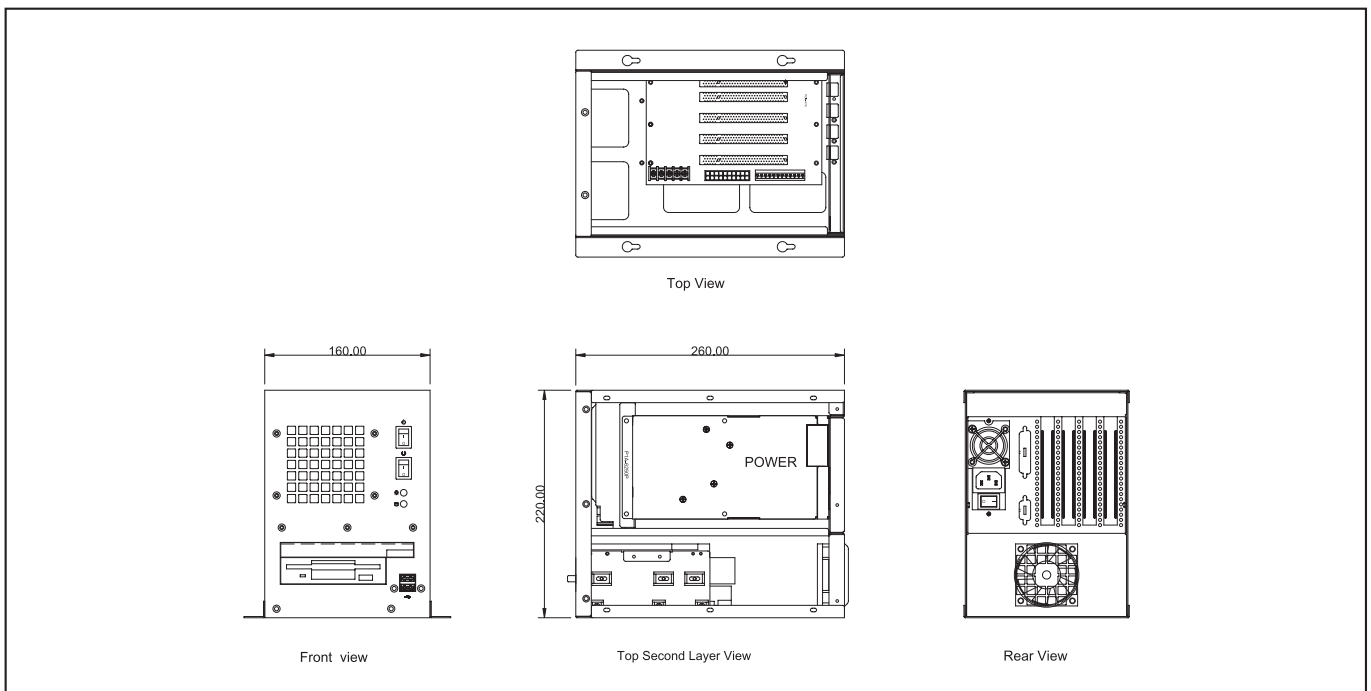

GHB-060

6-slot Micro Box Chassis



Specifications

- **Mounting:** Desktop or Wall Mount
- **Construction:** Heavy Duty Cold Rolled Electroplated Steel
- **Color:** Black (Standard), Beige or Custom
- **Support 6-slot Passive Backplane**
- **Drive Capacity:** 1x 5.25" & 1x 3.5"FDD & 1x 3.5"HDD & 1x 3.5"HDD(Optional)
- **Power Supply(Optional):** PS/2 Size Single up to 700W or Mini Redundant up to 500W ATX P/S (Rear Installation)
- **Cooling:** 1x(120mm = 90CFM ea.) Fan
- **Front Door:** Single Door With 2 Thumbscrews
- **Air Filter:** Inside Front Panel (Washable)
- **Connector Port (Front):** 1x PS/2 Port
- **Thermal Management Card:** GHA-CO01
- **Indicators:** LEDs for Power ON/OFF, HDD Activity, Fan, Temperature
- **Flexible Hold Down Bar Designed**
- **Switch:** Power ON/OFF, System Reset, Buzzer Reset
- **Dimensions(WxHxD):** 307x177x421mm(12" x 7" x 16.6")
- **Cuft:** 2.9
- **GW:** 11.9 kgs / 26.2 lbs
- **Carton Size(cm):** 45.5 x 32.4 x 55.8 (17.9" x 12.8" x 22")
- **Humidity:** 5% - 95% Non-condensin

Dimension

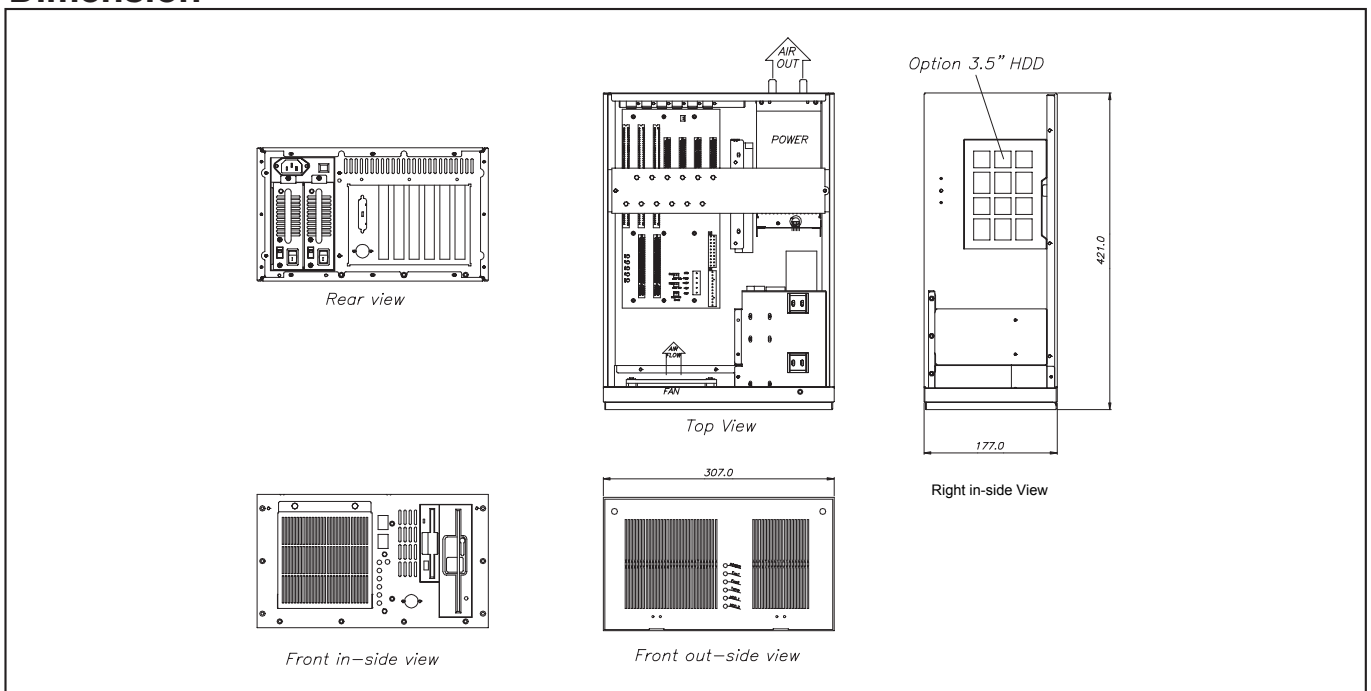

GHB-061

6-slot Micro Box Chassis



Specifications

- **Mounting:** Desktop or Wall Mount
- **Construction:** Heavy Duty Cold Rolled Electroplated Steel
- **Color:** Black (Standard), Beige or Custom
- **Support Flex ATX M/B and Micro ATX M/B**
- **Drive Capacity:** 1x 5.25" & 1x 3.5" & 1x 3.5"HDD
- **Power Supply(Optional):** 1U Single 250~300W ATX P/S (Mid Installation)
- **Cooling:** 1x (90mm = 51CFM ea.) Fan
- **Front Door:** Single Door With 2 Thumbscrews
- **With Portable Handle**
- **Air Filter:** Inside Front Panel (Washable)
- **Connector Port(Front):** 2xUSB Ports
- **Thermal Management Card:** GHA-CO04
- **Indicators:** LEDs for Power ON/OFF, HDD Activity, Fan, Temperature
- **Flexible Hold Down Bar Designed**
- **Switch:** Power ON/OFF, System Reset, Buzzer Reset
- **Dimensions (WxHxD):** 307x177x421mm(12" x 7" x 16.6")
- **Cuft:** 2.9
- **GW:** 12.0 kgs / 26.5 lbs
- **Carton Size(cm):** 45.5 x 32.4 x 55.8 (17.9" x 12.8" x 22")
- **Humidity:** 5% - 95% Non-condensing

Dimension

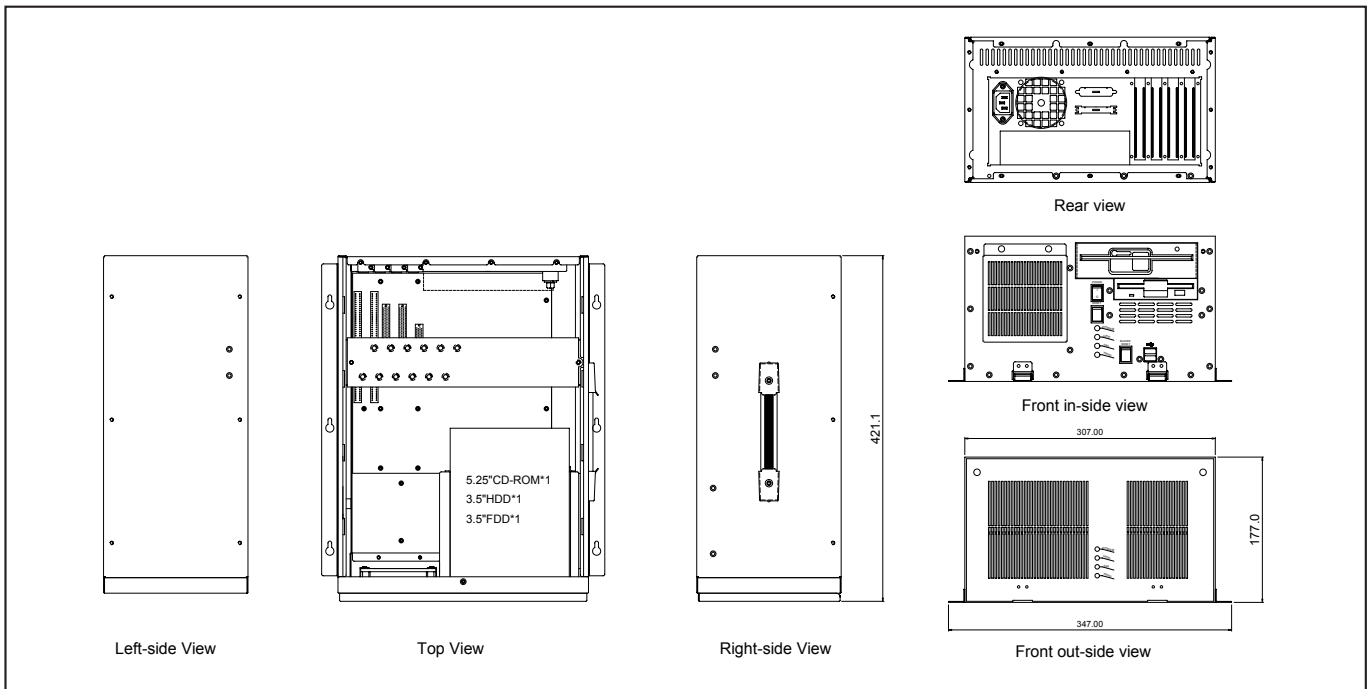

GHB-062-6

6-slot Micro Box Chassis



19" Rackmount

Specifications

- **Mounting:** Desktop or Wall Mount
- **Construction:** Heavy Duty Cold Rolled Electroplated Steel
- **Color:** Black (Standard), Beige or Custom
- **Supports 6-slot Passive Backplane**
- **Drive Capacity:** 1x 5.25", 1x 3.5" HDD, 1x 3.5" FDD, & 1x 3.5" HDD (Optional)
- **Power Supply (Optional):** PS/2 Size Single or Mini Redundant up to 500W ATX P/S
- **Cooling:** 1x (120mm = 90CFM) Fan
- **Air Filter:** Inside Front Panel (Washable)
- **Connector Port (Front):** 2x USB Ports
- **Thermal Management Card:** GHA-CO04
- **Indicators:** LEDs for Power ON/OFF, HDD Activity, Fan, Temperature
- **Flexible Hold Down Bar Designed**
- **Switch:** Power ON/OFF Momentary (Rocker), System Reset, Buzzer Reset
- **Dimensions (WxHxD):** 307x177x412 mm(12"x7"x16.2")
- **Cuft:** 2.9
- **GW:** 12.0kgs / 26.5lbs
- **Carton Size(cm):** 45.5 x 32.4 x 55.8 (17.9" x 12.8" x 22")
- **Humidity:** 5% - 95% Non-condensing

Dimension

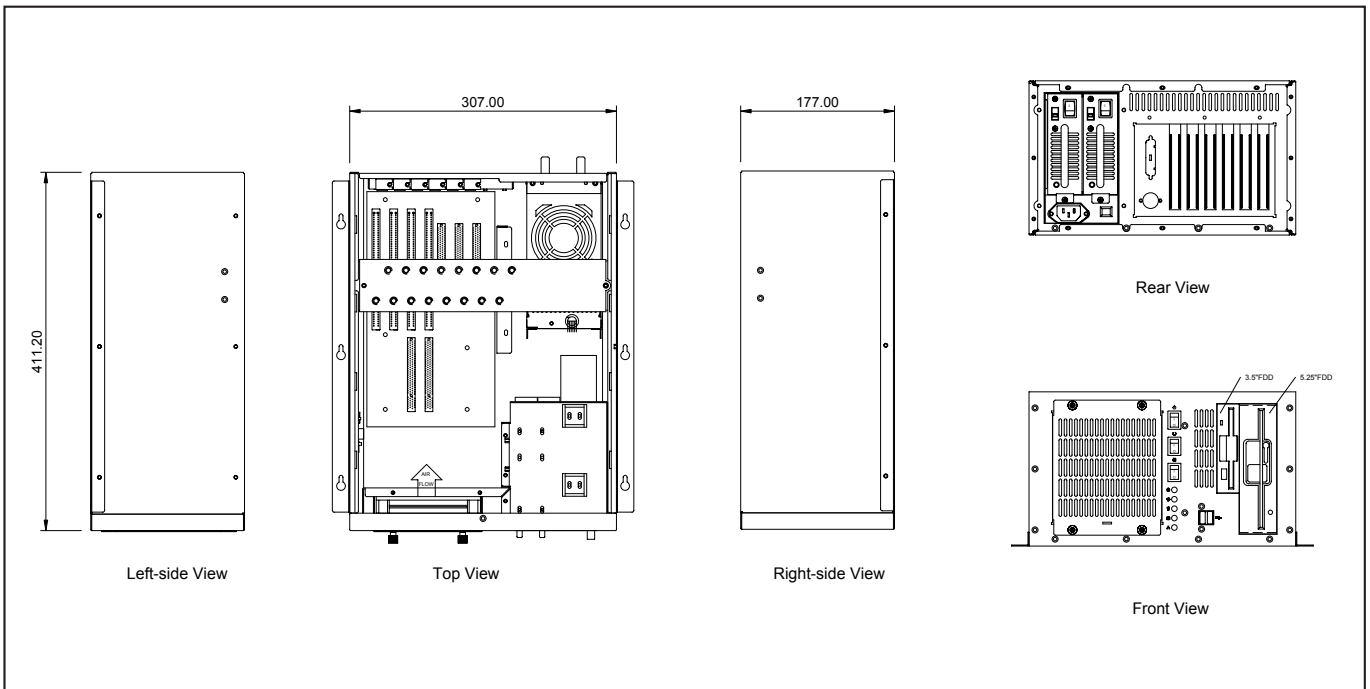

GHB-062-8

8-slot Micro Box Chassis



Specifications

- **Mounting:** Desktop or Wall Mount
- **Construction:** Heavy Duty Cold Rolled Electroplated Steel
- **Color:** Black (Standard), Beige or Custom
- **Supports 8-slot Passive Backplane**
- **Drive Capacity:** 1x 5.25" & 1x 3.5" FDD & 1x 3.5" HDD
- **Power Supply (Optional):** 1U Single up to 350W ATX P/S (Rear Installation) Max. Depth 225mm
- **Cooling:** 1x (120mm = 90CFM ea.) Fan
- **Air Filter:** Inside Front Panel (Washable)
- **Connector Port (Front):** 2x USB Ports
- **Thermal Management Card:** GHA-CO04
- **Indicators:** LEDs for Power ON/OFF, HDD Activity, Fan, Temperature
- **Flexible Hold Down Bar Designed**
- **Switch:** Power ON/OFF Momentary (Rocker), System Reset, Buzzer Reset
- **Dimensions(WxHxD):** 307 x 177 x 412 mm(12"x7"x16.2")
- **Cuft:** 2.9
- **GW:** 12.0 kgs / 26.5 lbs
- **Carton Size(cm):** 45.5 x 32.4 x 55.8 (17.9" x 12.8" x 22")
- **Humidity:** 5% - 95% Non-condensing

Dimension

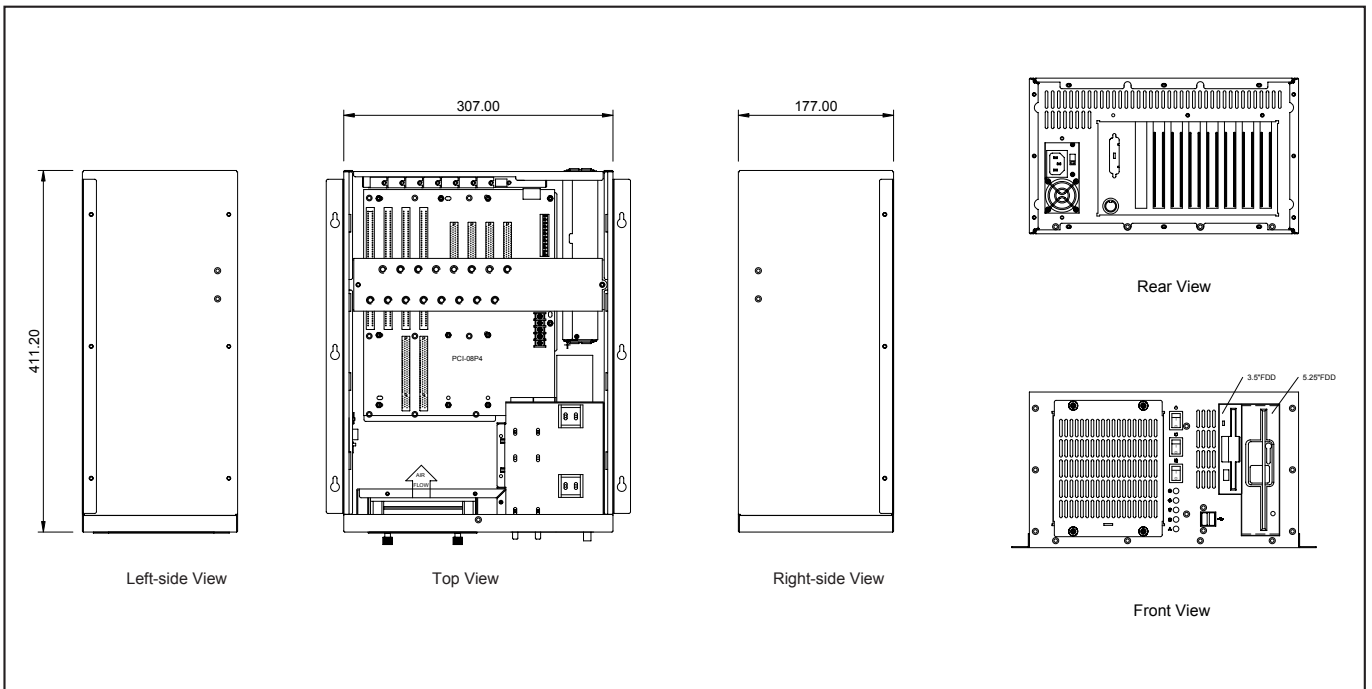

GHB-080

8-slot Micro Box Chassis

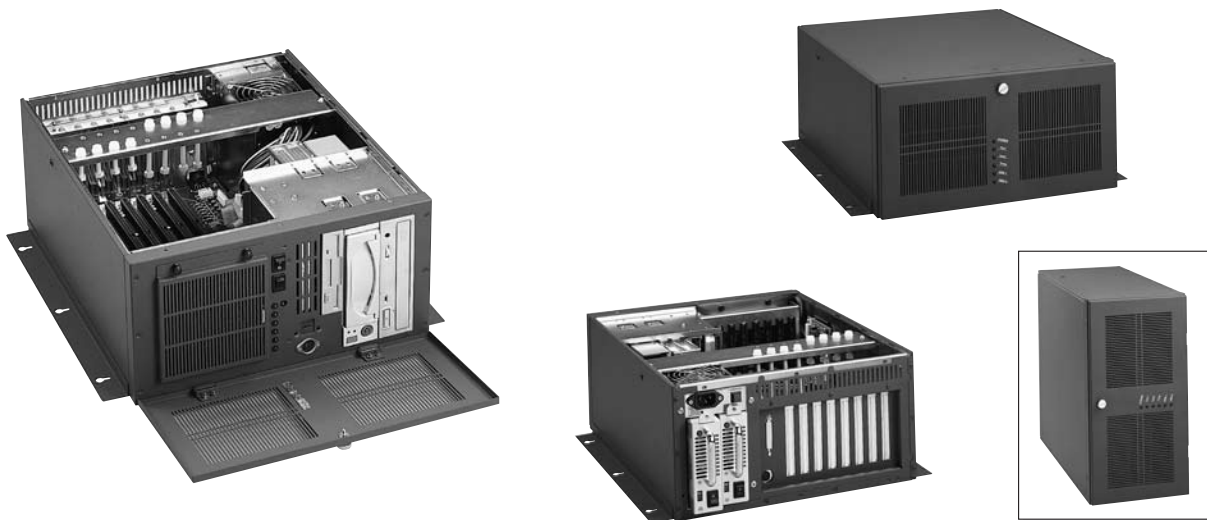

19" Rackmount

Specifications

- **Mounting:** Desktop or Wall Mount
- **Construction:** Heavy Duty Cold Rolled Electroplated Steel
- **Color:** Black (Standard), Beige or Custom
- **Support 8-slot Passive Backplane**
- **Drive Capacity:** 2x 5.25" & 1x 3.5" & 1x 3.5"HDD
- **Power Supply(Optional):** PS/2 Size Single 250~400W or Redundant 230~400W P/S(Rear Installation) Max. Depth 225mm
- **Cooling:** 1x (120mm = 90CFM ea.) Fan
- **Front Door:** Single Door With 1 Thumbscrew
- **Air Filter:** Inside Front Panel (Washable)
- **Connector Port (Front):** 1x PS/2 Port or 2 X USB Ports (Optional)
- **Thermal Management Card:** GHA-CO01
- **Indicators:** LEDs for Power ON/OFF, HDD Activity, Fan, Temperature
- **Flexible Hold Down Bar Designed**
- **Switch:** Power ON/OFF, System Reset, Buzzer Reset
- **Dimensions(WxHxD):** 350x177x421mm(13.8" x 7" x 16.6")
- **Cuft:** 3.1
- **GW:** 15.0 kgs / 33.1 lbs
- **Carton Size(cm):** 49 x 32.4 x 55.8(19.3" x 12.8" x 22")
- **Humidity:** 5% - 95% Non-condensing

Dimension

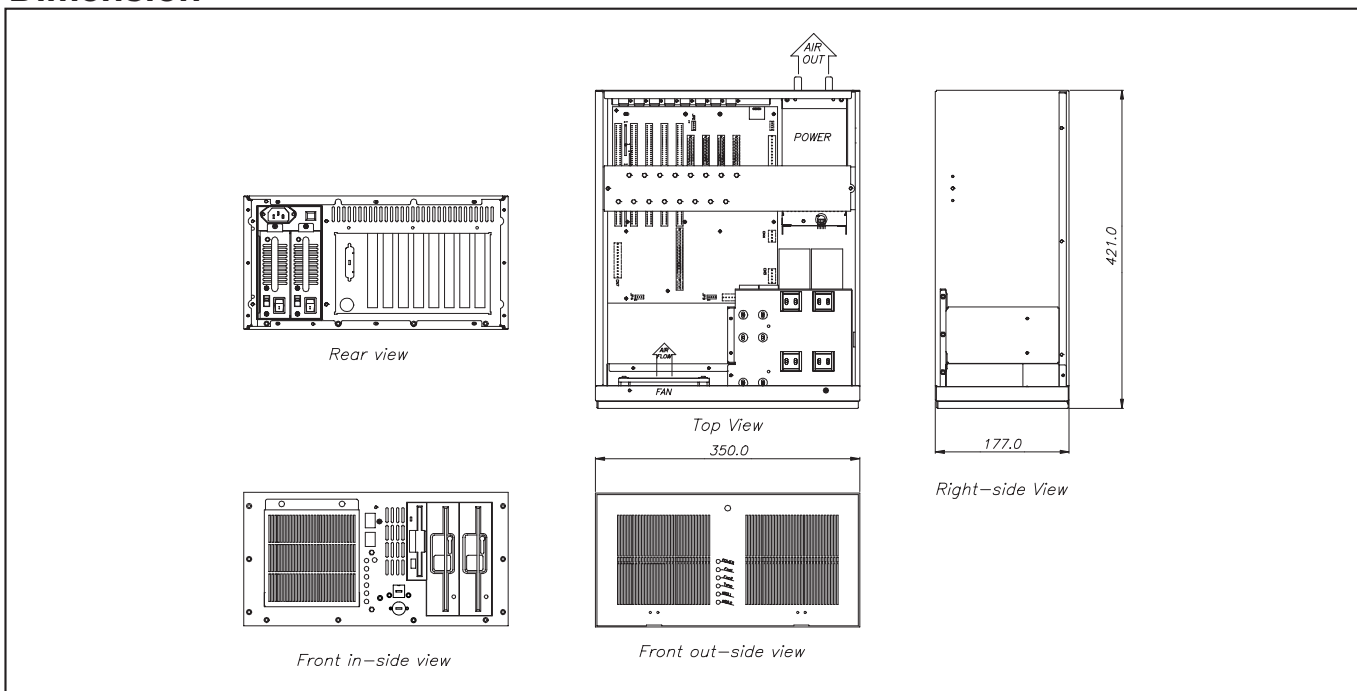

GHB-081

8-slot Micro Box Chassis



Specifications

- **Mounting:** Desktop or Wall Mount
- **Construction:** Heavy Duty Cold Rolled Electroplated Steel
- **Color:** Black (Standard), Beige or Custom
- **Support EATX M/B (12" x 10.5") SSI EEB 3.0**
- **Drive Capacity:** 2x 5.25"(160mm) & 1x 3.5"FDD
- **Power Supply(Optional):** 1U Single up to 500W ATX P/S(Mid Installation) Max. Depth 225mm
- **Cooling:** 1x (120mm= 90CFM) With Removable Air Filter Fan
- **Air Filter:** Inside Front Panel (Washable)
- **Connector Port (Front):** 2x USB Ports
- **Thermal Management Card:** GHA-CO04
- **Indicators:** LEDs for Power ON/OFF, HDD Activity, Fan, Temperature, LAN
- **Flexible Hold Down Bar Designed**
- **Switch:** Power ON/OFF, System Reset, Buzzer Reset
- **Dimensions (W x H x D):** 350 x 177 x 411mm (13.8" x 7" x 16.2")
- **Cuft:** 3.1
- **GW:** 12.9 kgs / 28.5 lbs
- **Carton Size(cm):** 49 x 32.4 x 55.8 (19.3" x 12.8" x 22")
- **Humidity:** 5% - 95% Non-condensing

Dimension

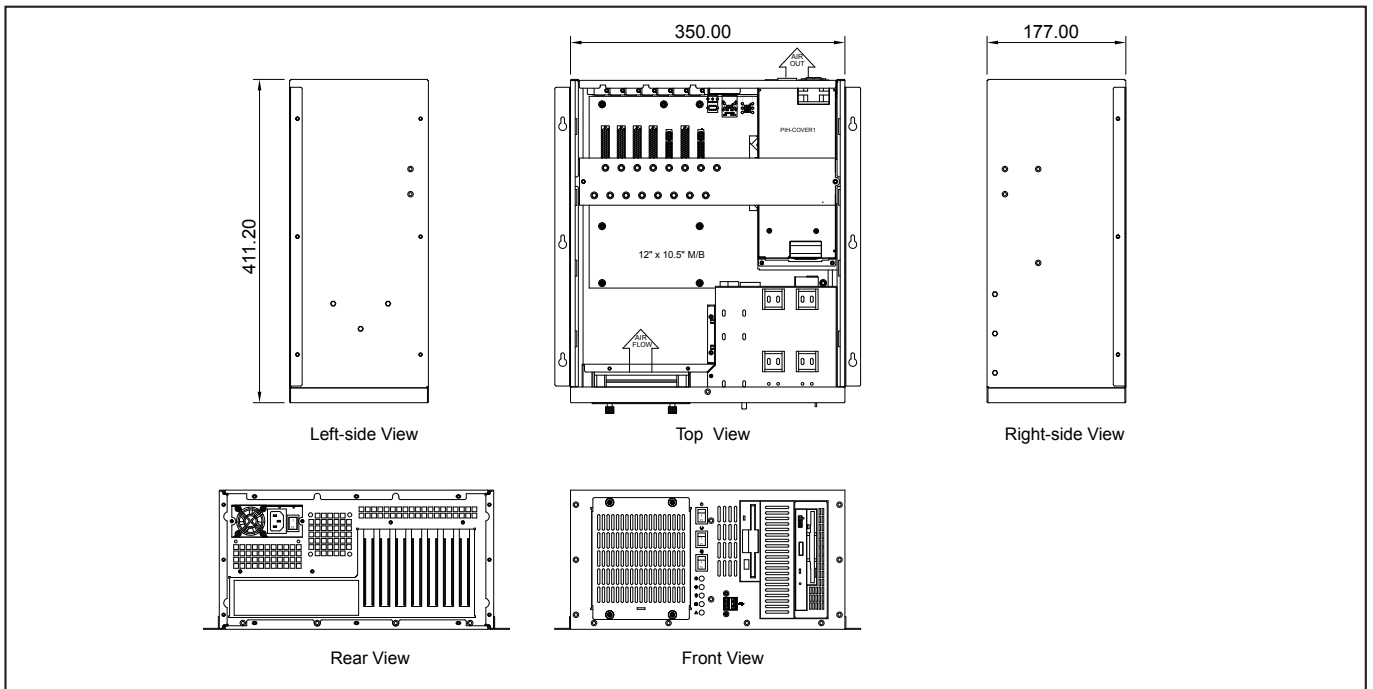

GHB-082-8

8-slot Micro Box Chassis



19" Rackmount

Specifications

- **Mounting:** Desktop or Wall Mount
- **Construction:** Heavy Duty Cold Rolled Electroplated Steel
- **Color:** Black (Standard), Beige or Custom
- **Support 8-slot Passive Backplane**
- **Drive Capacity:** 2x5.25" & 1x3.5" & 1x3.5"HDD
- **Power Supply(Optional):** PS/2 Size Single 250~400W or Redundant 230~400W P/S(Rear Installation) Max. Depth 225mm
- **Cooling:** 1x (120mm=90CFM ea.) Fan
- **Without Front Door.**
- **Air Filter:** Inside Front Panel (Washable)
- **Connector Port (Front):** 2x USB Ports
- **Thermal Management Card:** GHA-CO04
- **Indicators:** LEDs for Power ON/OFF, HDD Activity, Fan, Temperature, LAN
- **Flexible Hold Down Bar Designed**
- **Switch:** Power ON/OFF, System Reset, Buzzer Reset
- **Dimensions (WxHxD):** 350 x 177 x 411mm (13.8"x7"x16.2")
- **Cuft:** 3.1
- **GW:** 13.2 kgs / 29.1 lbs
- **Carton Size(cm):** 49 x 32.4 x 55.8(19.3" x 12.8" x 22")
- **Humidity:** 5% - 95% Non-condensing

Dimension

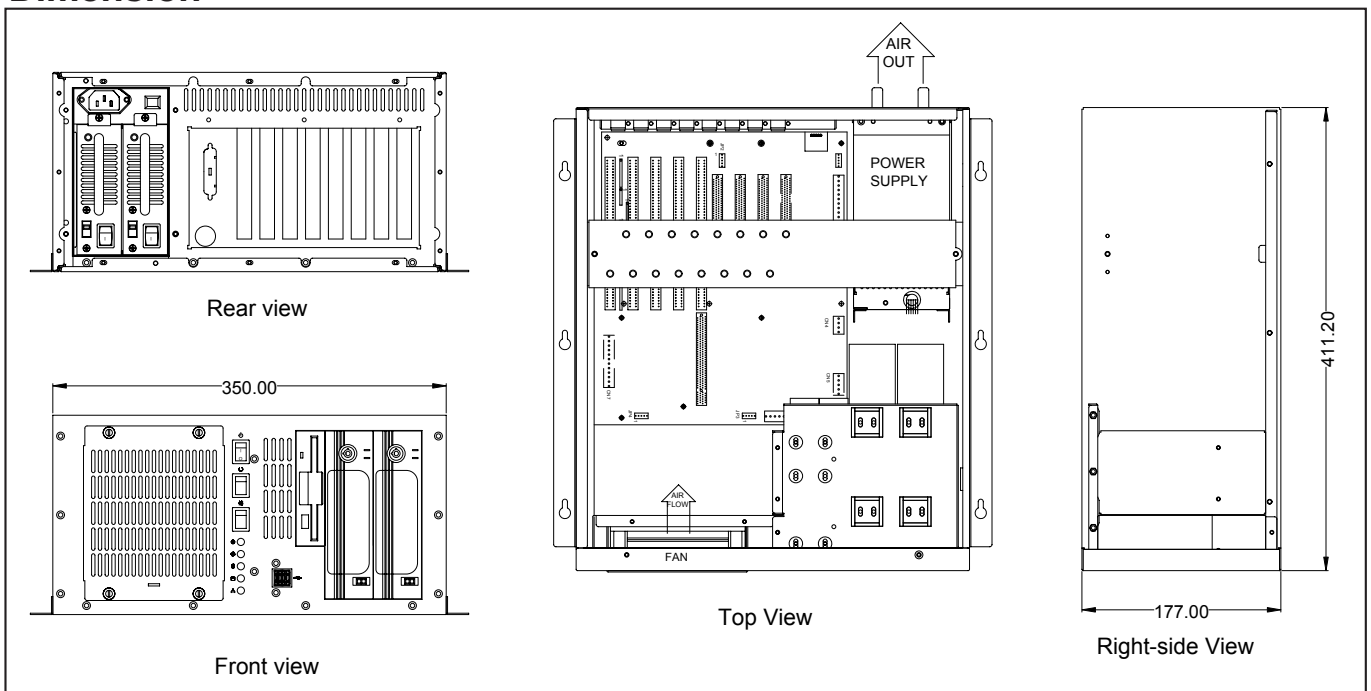

GHB-082-10

10-slot Micro Box Chassis

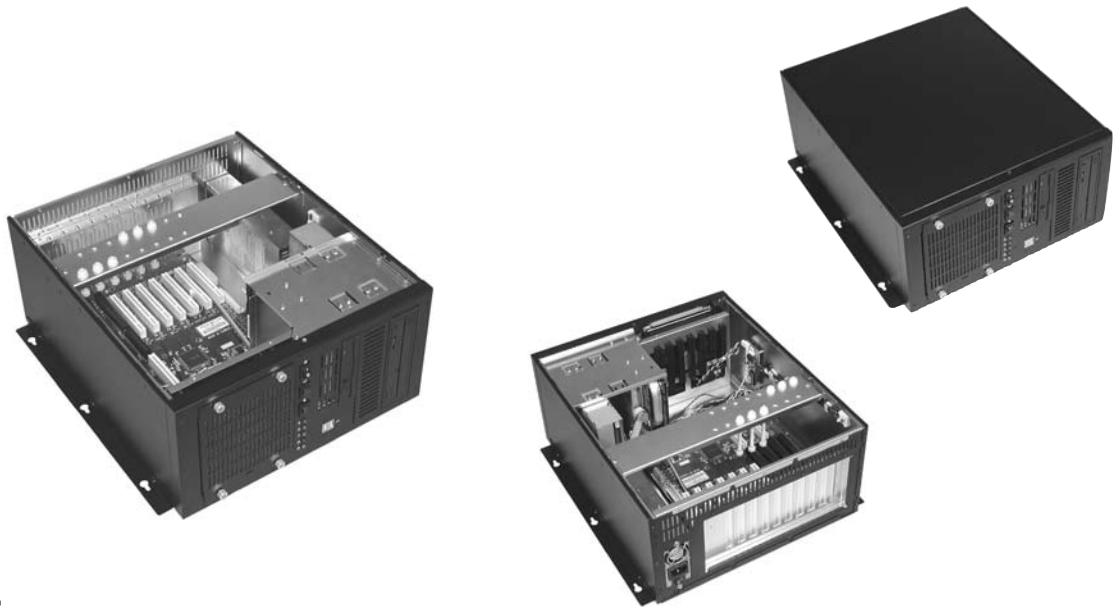

Specifications

- **Mounting:** Desktop or Wall Mount
- **Construction:** Heavy Duty Cold Rolled Electroplated Steel
- **Color:** Black (Standard), Beige or Custom
- **Support 10-slot Passive Backplane**
- **Drive Capacity:** 1x 5.25" & 1x 3.5" & 1x 3.5"HDD
- **Power Supply(Optional):** 1U Size Single 250~400W P/S
- **Cooling:** 1x (120mm = 90CFM ea.) Fan
- **Without Front Door.**
- **Air Filter:** Inside Front Panel (Washable)
- **Connector Port (Front):** 2x USB Ports
- **Thermal Management Card:** GHA-CO04
- **Indicators:** LEDs for Power ON/OFF, HDD Activity, Fan, Temperature, LAN
- **Flexible Hold Down Bar Designed**
- **Switch:** Power ON/OFF, System Reset, Buzzer Reset
- **Dimensions (WxHxD):** 350x177x411mm(13.8"x7"x16.2")
- **Cuft:** 3.1
- **GW:** 15.0 kgs / 33.1 lbs
- **Carton Size(cm):** 49 x 32.4 x 55.8(19.3" x 12.8" x 22")
- **Humidity:** 5% - 95% Non-condensing

Dimension

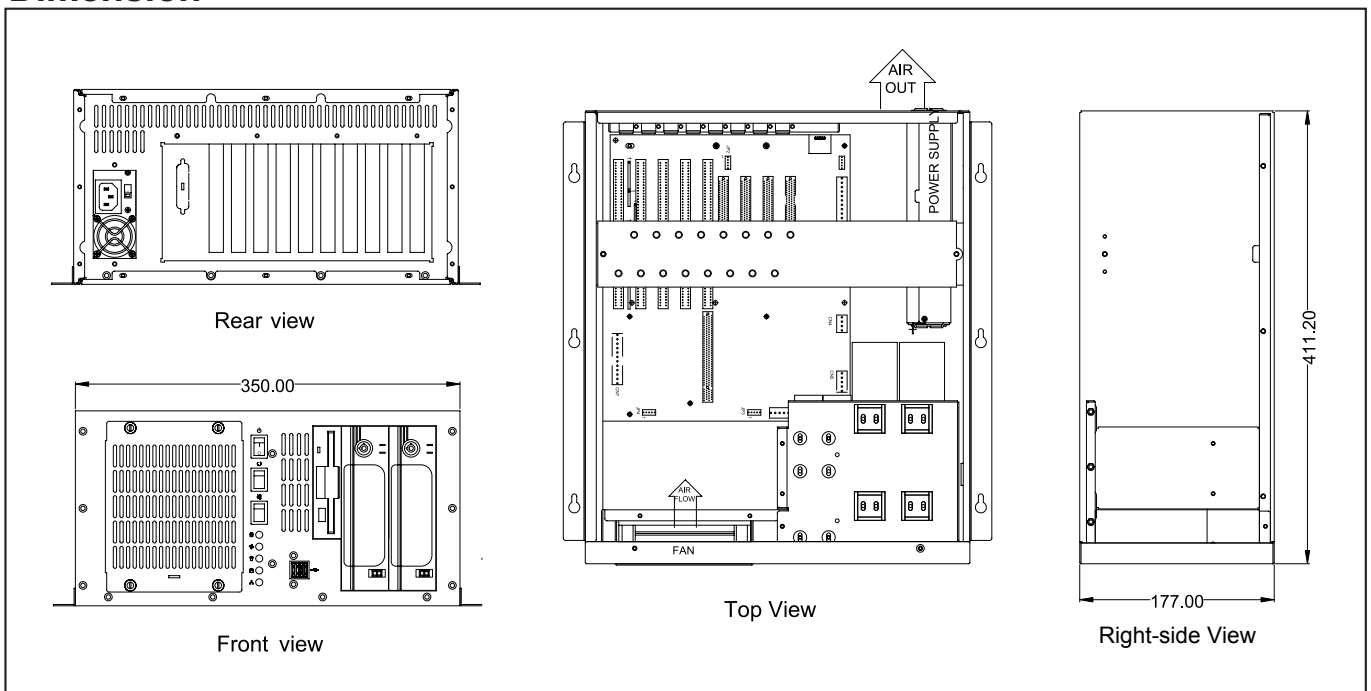

GHB-083-8

8-slot Micro Box Chassis

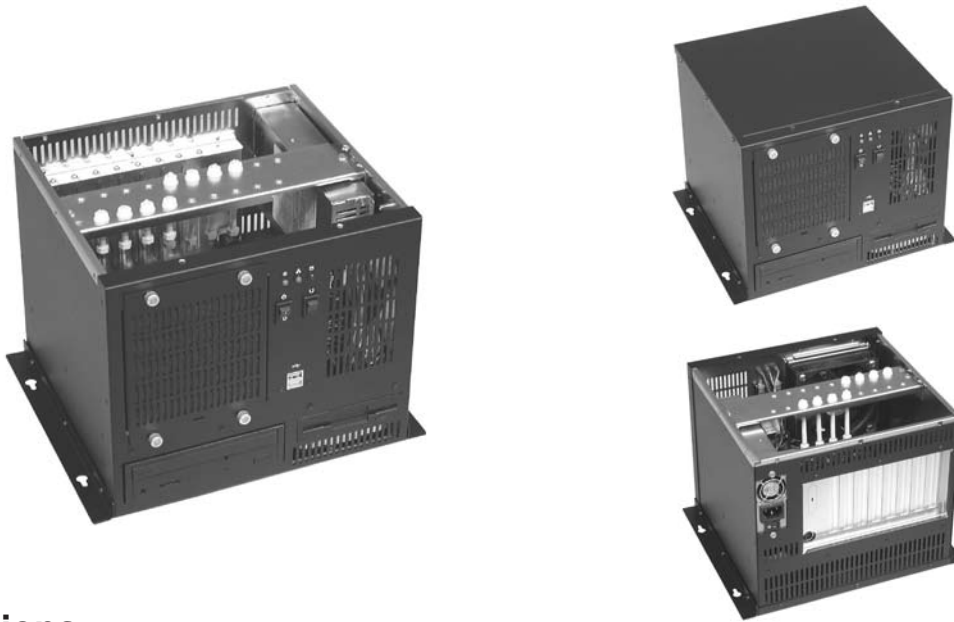

19" Rackmount

Specifications

- **Mounting:** Desktop or Wall Mount
- **Construction:** Heavy Duty Cold Rolled Electroplated Steel
- **Color:** Black (Standard), Beige or Custom
- **Support 8-slot Passive Backplane**
- **Drive Capacity:** 1x 5.25" & 1x 3.5" & 1x 3.5"HDD
- **Power Supply(Optional):** 1U 200~300W P/S
- **Cooling:** 1x (120mm = 90CFM ea.) Fan
- **Air Filter:** Inside Front Panel (Washable)
- **Connector Port (Front):** 2x USB Ports
- **Indicators:** LEDs for Power ON/OFF, HDD Activity, LAN
- **Flexible Hold Down Bar Designed**
- **Switch:** Power ON/OFF, System Reset
- **Dimensions (WxHxD):** 280 x 237 x 260mm (11" x 9.3" x 10.2")
- **Cuft:** 2.3
- **GW:** 8.5 kgs / 18.7 lbs
- **Carton Size(cm):** 42 x 38 x 40(16.5" x 15" x 15.8")
- **Humidity:** 5% - 95% Non-condensing

Dimension

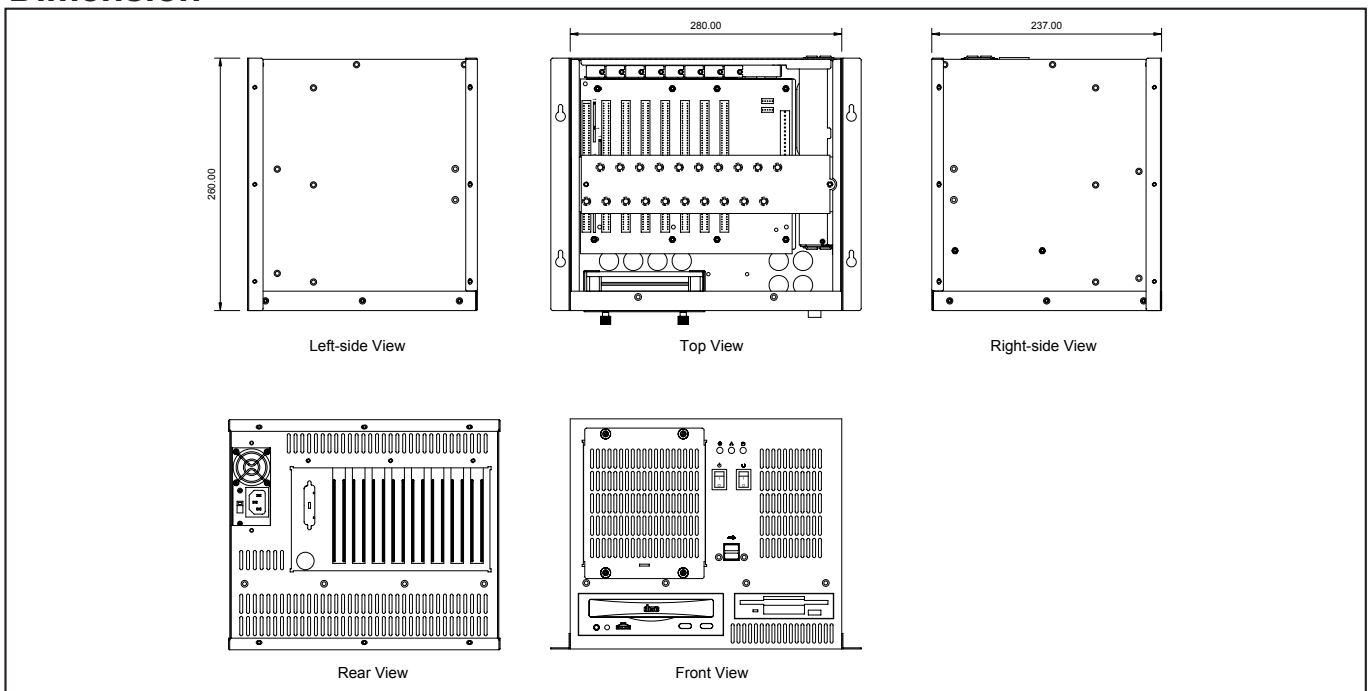

GHB-083-10

10-slot Micro Box Chassis

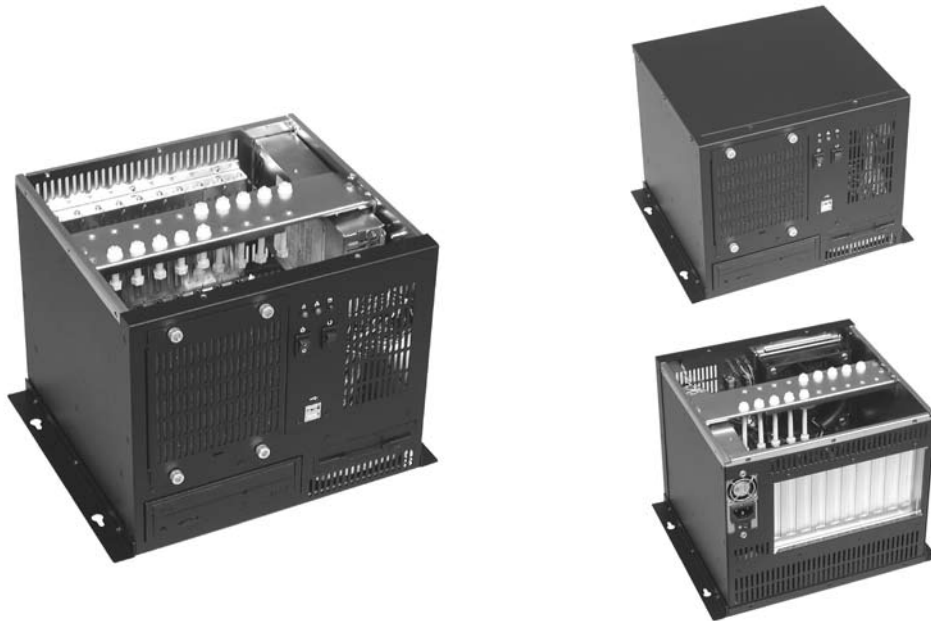

Specifications

- **Mounting:** Desktop or Wall Mount
- **Construction:** Heavy Duty Cold Rolled Electroplated Steel
- **Color:** Black (Standard), Beige or Custom
- **Support 10-slot Passive Backplane**
- **Drive Capacity:** 1x 5.25" & 1x 3.5" & 1x 3.5"HDD
- **Power Supply(Optional):** 1U 200~300W P/S
- **Cooling:** 1x (120mm = 90CFM ea.) Fan
- **Air Filter:** Inside Front Panel (Washable)
- **Connector Port (Front):** 2x USB Ports
- **Indicators:** LEDs for Power ON/OFF, HDD Activity, LAN
- **Flexible Hold Down Bar Designed**
- **Switch:** Power ON/OFF, System Reset
- **Dimensions(WxHxD):** 280 x 237 x 260mm (11" x 9.3" x 10.2")
- **Cuft:** 2.3
- **GW:** 8.5 kgs / 18.7 lbs
- **Carton Size(cm):** 42.0 x 38 x 40(16.5" x 15" x 15.8")
- **Humidity:** 5% - 95% Non-condensing

Dimension

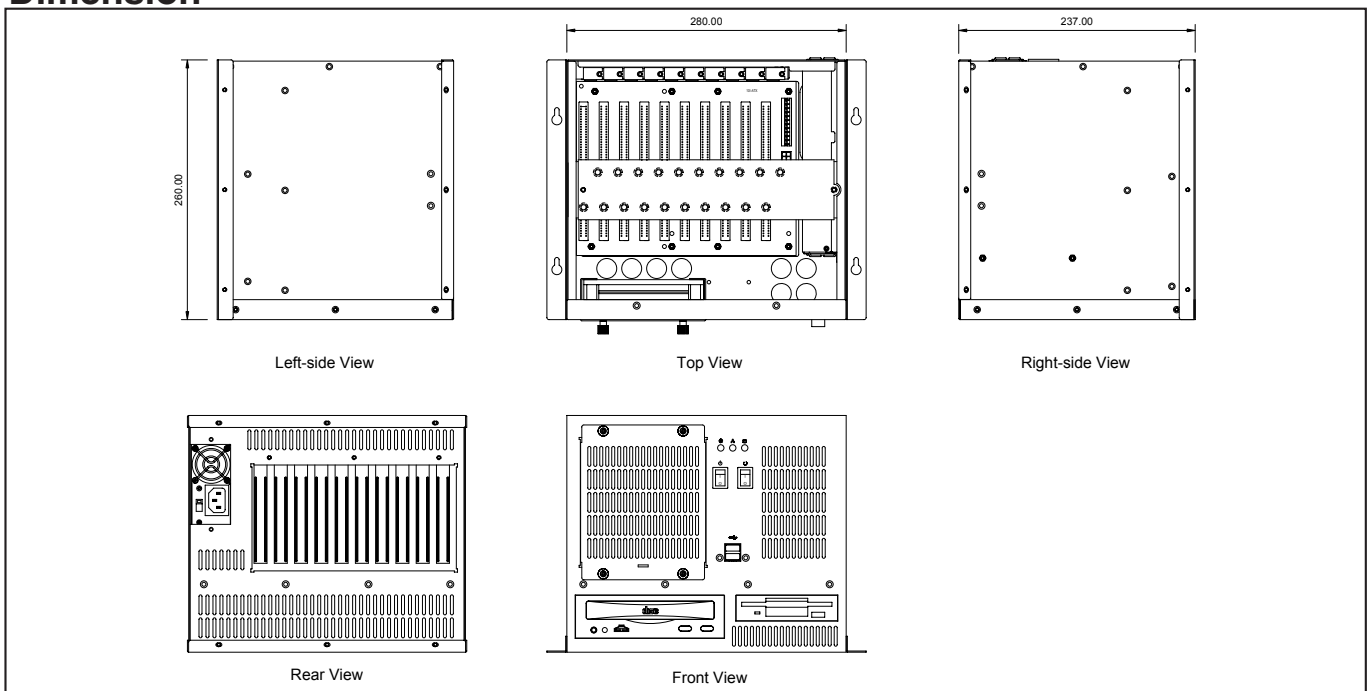

GHB-120ATXR/120SR

Micro Box Chassis



19" Rackmount

Specifications

- **Mounting:** Desktop or Wall Mount
- **Construction:** Heavy Duty Cold Rolled Electroplated Steel
- **Color:** Black (Standard), Beige or Custom
- **Support Flex ATX M/B and Micro ATX M/B(120ATXR)**
- **Support 10/12-slot Passive Backplane(9 Full Length Card)(120SR)**
- **Drive Capacity:** 2x 5.25" & 2x 3.5" & 1x 3.5"HDD
- **Power Supply(Optional):** PS/2 Size Single up to 400W or Redundant up to 300W ATX P/S (Rear Installation) Max. Depth 225mm
- **Cooling:** 1x (120mm = 90CFM ea.) Fan
- **Front Door:** Single Door With 2 Thumbscrews
- **Connector Port (Front):** 2x USB Ports (Optional)
- **Air Filter:** Inside Front Panel (Washable)
- **Thermal Management Card:** GHA-CO01
- **Indicators:** LEDs for Power ON/OFF, HDD Activity, Fan, Temperature
- **Flexible Hold Down Bar Designed**
- **Switch:** Power ON/OFF, System Reset, Buzzer Reset
- **Dimensions (WxHxD):** 400x177x420mm(15.7"x7"x16.5")
- **Cuft:** 3.6
- **GW:** 15.0 kgs / 33.1 lbs
- **Carton Size(cm):** 56.1 x 33 x 54.8(22.1" x 13" x 21.6")
- **Humidity:** 5% - 95% Non-condensing

Dimension

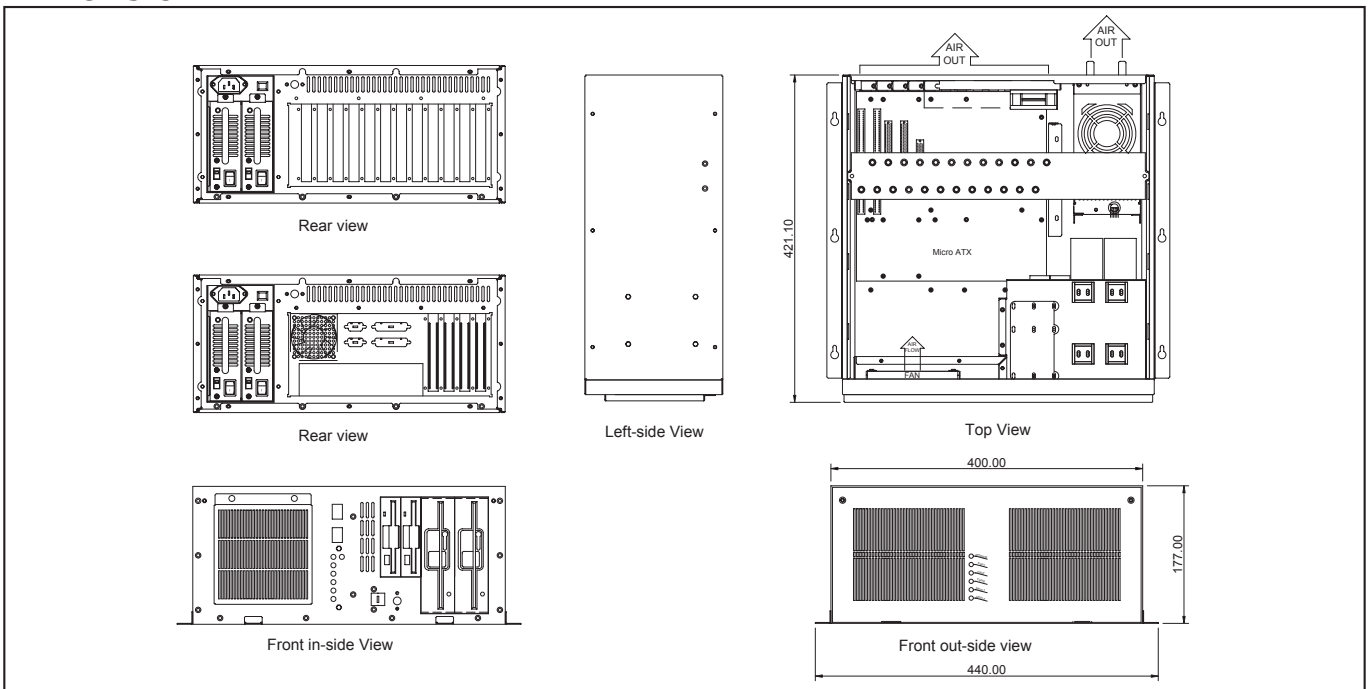

GHK-M01

1U 15" LCD Monitor

19" Rackmount



Specifications

- **EIA RS-310C 19" Rackmount Standard**
- **Construction:** Heavy Duty Cold Rolled Electroplated Steel
- **Color:** Black (Standard) or Beige
- **LCD Size:** 15" TFT with 1024x768 Resolution
- **LCD Quality:** Luminance(250 cd/m²)
- **Keyboard:** 83/84 Key with Integrated Track Ball + 2 Mouse Buttons
- **Power Supply:** 12V/48W, 100~240V Auto Ranging PSU
- **Key Lock:** Yes
- **Indicators:** LED for Power
- **Switch:** Power ON/OFF, Brightness, Contrast, Menu
- **Dimensions(WxHxD):** 483 x 44 x 530mm (19" x 1.7" x 20.9")
- **Cuft:** 4.1
- **GW:** 20.0kgs / 44.1lbs
- **Carton Size(cm):** 75.1 x 23.3 x 67(29.6" x 9.2" x 26.4")
- **Humidity:** 5% - 95% Non-condensing

Dimension

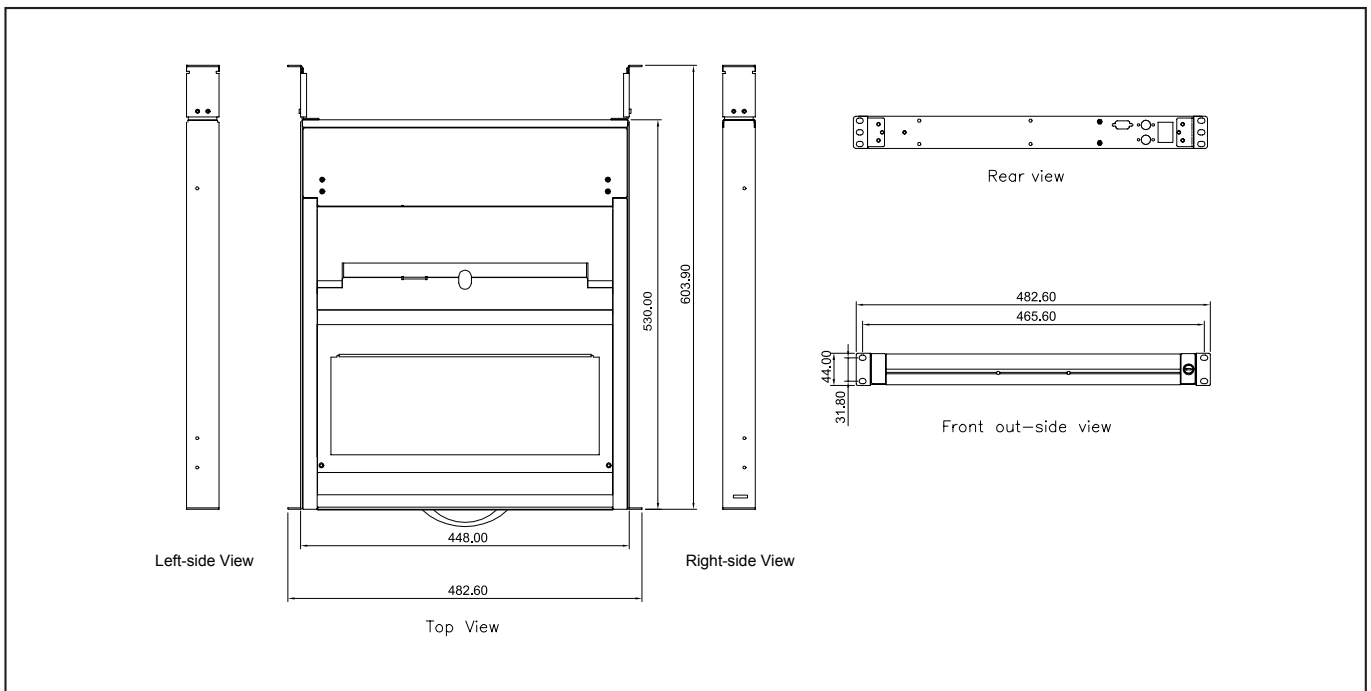

GHK-M02

1U 15" LCD Monitor with 8-ports KVM



19" Rackmount

Specifications

- **EIA RS-310C 19" Rackmount Standard**
- **Construction:** Heavy Duty Cold Rolled Electroplated Steel
- **Color:** Black (Standard), Beige or Custom
- **LCD Size:** 15" TFT with 1024x768 Resolution
- **LCD Quality:** Luminance(250 cd/m²)
- **Keyboard:** 83/84 Key with Integrated Track Ball + 2 Mouse Buttons
- **Power Supply:** 12V/48W, 100~240V Auto Ranging PSU
- **Key Lock:** Yes
- **Indicators:** LED for Power
- **Switch:** Power ON/OFF, Brightness, Contrast, Menu
- **KVM:** 8 Ports
- **Dimensions(WxHxD):** 483 x 44 x 643mm(19"x1.7"x25.3")
- **Cuft:** 4.5
- **GW:** 22.0 kgs / 48.5 lbs
- **Carton Size(cm):** 88.2 x 23.3 x 61.8(34.7"x9.2"x24.3")
- **Humidity:** 5% - 95% Non-condensing

Dimension

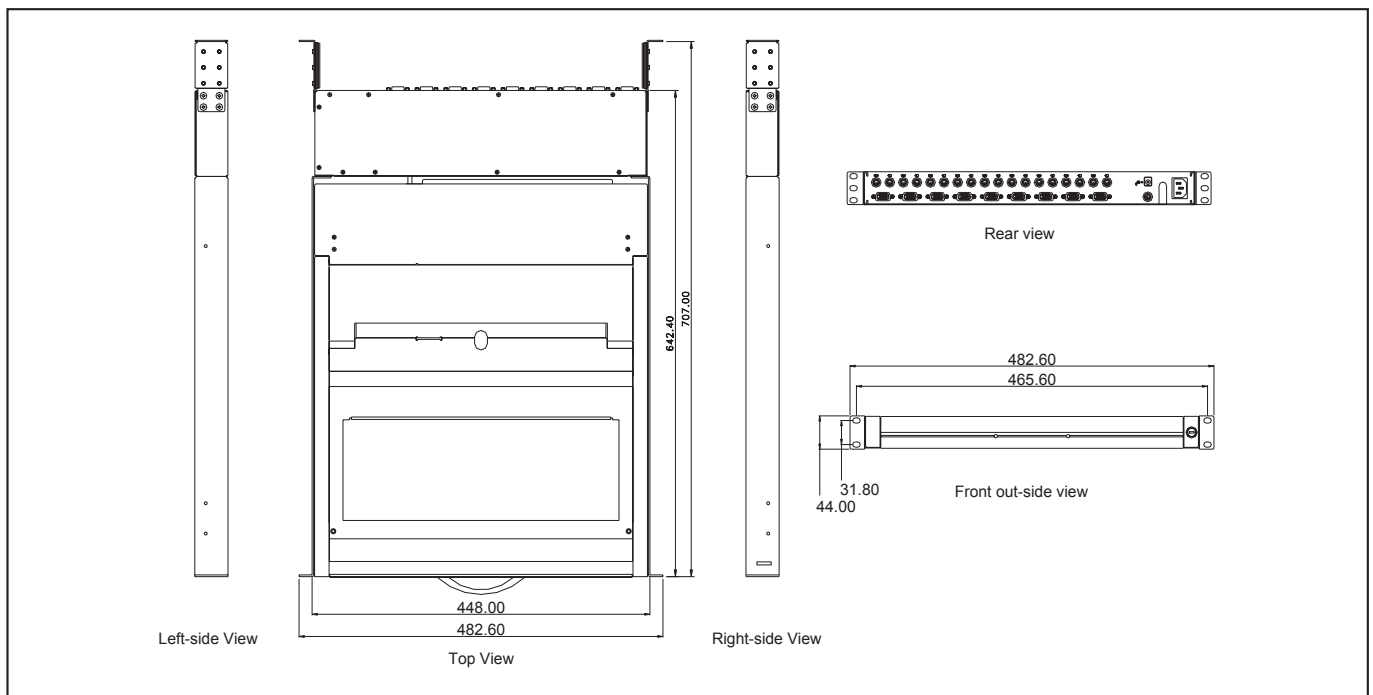

GHK-M03

1U 17" LCD Monitor

19" Rackmount



Specifications

- **EIA RS-310C 19" Rackmount Standard**
- **Construction:** Heavy Duty Cold Rolled Electroplated Steel or Aluminum
- **Color:** Black (Standard) or Beige
- **LCD Size:** 17" TFT With 1024x768 Resolution
- **LCD Quality:** Luminance(250 cd/m²)
- **Keyboard:** 83/84 Key With Integrated Track Ball + 2 Mouse Buttons
- **Power Supply:** 12V/48W, 100~240V Auto Ranging PSU
- **Key Lock:** Yes
- **Indications:** LED for Power
- **Switch:** Power ON/OFF, Brightness, Contrast, Menu
- **Dimensions(W x H x D):** 483 x 44 x 550mm (19"x1.7"x21.7")
- **Cuft:** 3.6
- **GW:** 20.3 kgs / 44.8 lbs
- **Carton Size(cm):** 73.5 x 22 x 63.3(28.9"x8.7"x24.9")
- **Humidity:** 5% - 95% Non-condensing

Dimension

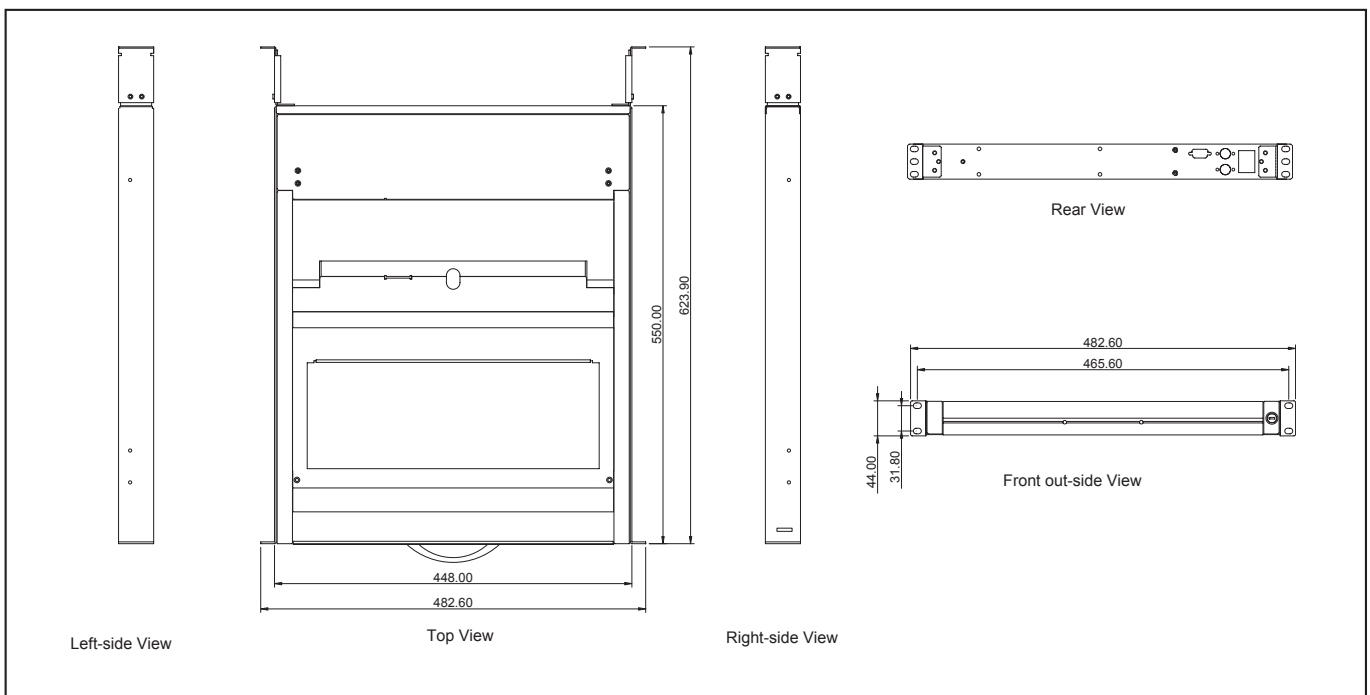

GHK-M04

1U 17" LCD Monitor with 8-ports KVM



19" Rackmount

Specifications

- **EIA RS-310C 19" Rackmount Standard**
- **Construction:** Heavy Duty Cold Rolled Electroplated Steel or Aluminum
- **Color:** Black (Standard) or Beige
- **LCD Size:** 17" TFT with 1024x768 Resolution
- **LCD Quality:** Luminance(250 cd/m²)
- **Keyboard:** 83/84 Key With Integrated Track Ball + 2 Mouse Buttons
- **Power Supply:** 12V/48W, 100~240V Auto Ranging PSU
- **Key Lock:** Yes
- **Indications:** LED for Power
- **Switch:** Power ON/OFF, Brightness, Contrast, Menu
- **Dimensions(W x H x D):** 483 x 44 x 662 mm (19" x 1.7" x 26.1")
- **Cuft:** 4.6
- **GW:** 20.2 kgs / 44.5 lbs
- **Carton Size(cm):** 90.2x23.3x61.8(35.5"x9.2"x24.3")
- **Humidity:** 5% - 95% Non-condensing

Dimension

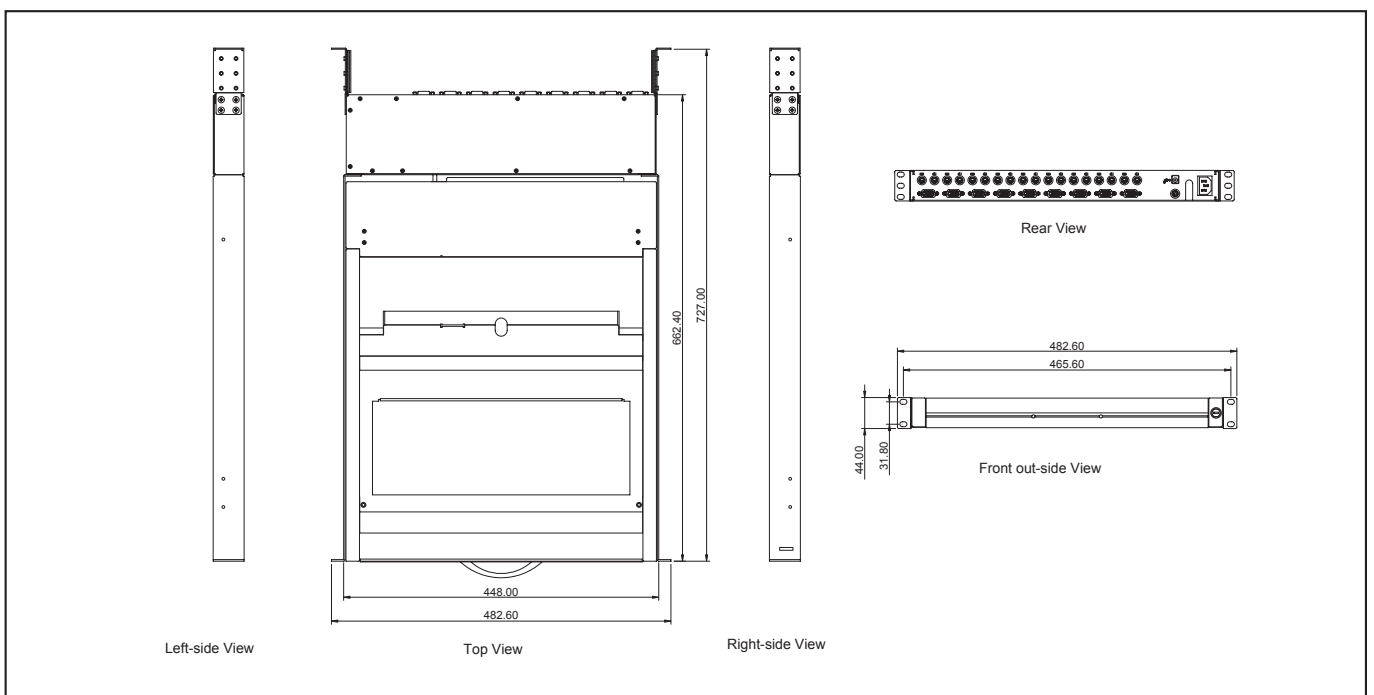

GH-K02



Specifications

- EIA RS-310C 19" 1U
- Rackmount Keyboard Drawer
- 104 Keys PS2 Keyboard
- Color: Beige or Black
- Rugged Sliding Rails with Handles & Key Lock
- Mouse Pad & Storage compartment
- Dimensions: 483(W)x44(H)x460(D)mm (19" x 1.7" x 18.1")
- Cuft: 1.3
- GW: 8.5 kgs / 18.7 lbs
- Carton Size(cm): 57.3 x 11.0 x 59.4 (22.6" x 4.3" x 23.4")

GH-KD1



Specifications

- EIA RS-310C 19" 1U
- Rackmount Keyboard Drawer Special Design for Cherry "G80-11900"Keyboard (Optional)
- Color: Beige or Black
- Rugged Sliding Rails with Handles & Key Lock
- Dimensions: 483(W)x44(H)x460(D)mm (19" x 1.7" x 18.1")
- Cuft: 1.3
- GW: 6.2 kgs / 13.7 lbs
- Carton Size(cm): 57.3 x 11.0 x 59.4 (22.6" x 4.3" x 23.4")

GH-KD4



Specifications

- EIA RS-310C 19" 1U
- Rackmount Keyboard Drawer
- Special Design for Cherry "G84-4400"Keyboard (Optional)
- Color: Beige or Black
- Rugged Sliding Rails with Handles & Key Lock
- Dimensions: 483(W)x44(H)x460(D)mm (19" x 1.7" x 18.1")
- Cuft: 1.3
- GW: 7.5 kgs / 16.5 lbs
- Carton Size(cm): 57.3 x 11.0 x 59.4 (22.6" x 4.3" x 23.4")

GHC-C01

1U Compact PCI



Compact PCI

Specifications

- **EIA RS-310C 19" Rack-mount Standard**
- **Construction:** Rittal System & Heavy Duty Cold Rolled Electroplated Steel
- **Color:** Black (Standard), Beige or Custom
- **Support:** 2-slot 64bit 6U cPCI Backplane with H.110 Compatible Pin Assignments on Peripheral Slot
- **Power Supply(Optional):** 1U Single up to 400W ATX P/S (Rear Installation) Max. Depth 250mm
- **Cooling:** 4x (40mm = 10.8CFM ea.) Fans
- **Indicators:** LEDs for Power ON/OFF
- **Switch:** Power ON/OFF, System Reset
- **Dimensions (W x H x D):** 483 x 44 x 323mm (19" x 1.7" x 12.7")
- **Cuft:** 1.7
- **GW:** 7.7 kgs / 17.0 lbs
- **Carton Size(cm):** 59.3 x 44.5 x 18.1(23.4" x 17.5" x 7.1")
- **Product Applications:** High end Firewall , VPN ,IDS ,Traffic Management

Dimension

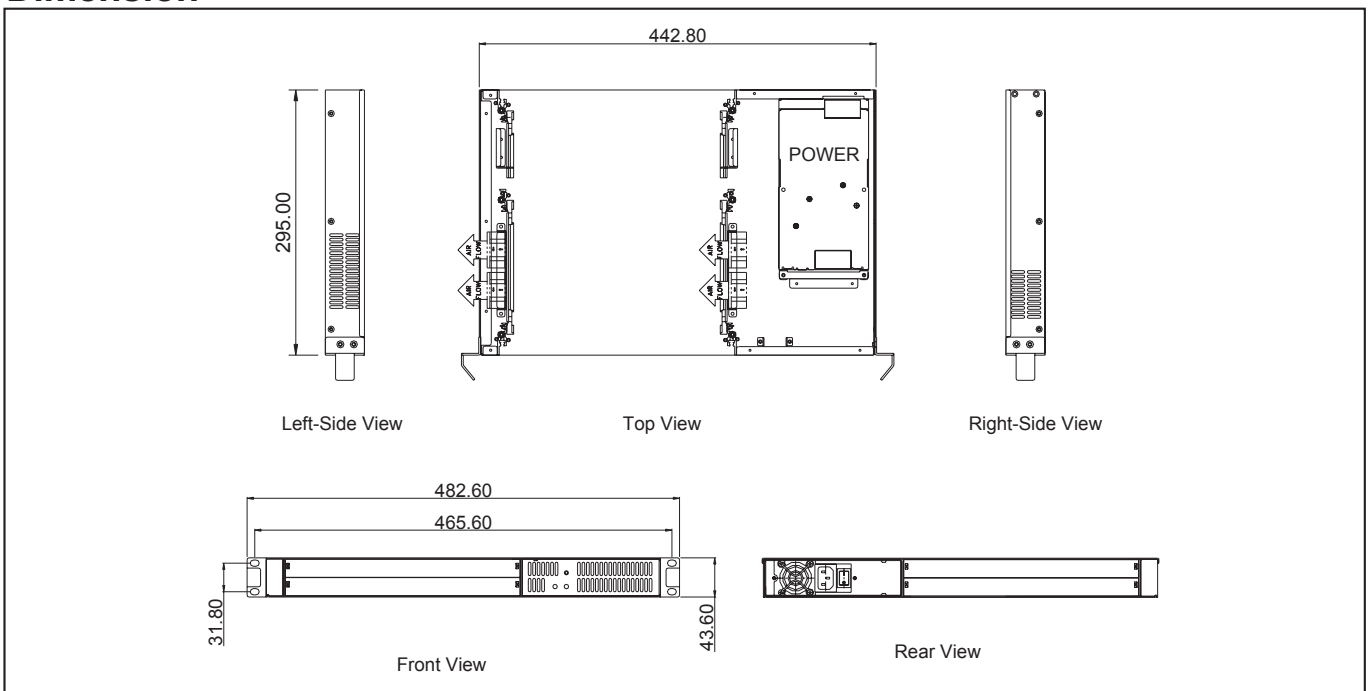

GHC-C02

2U Compact PCI

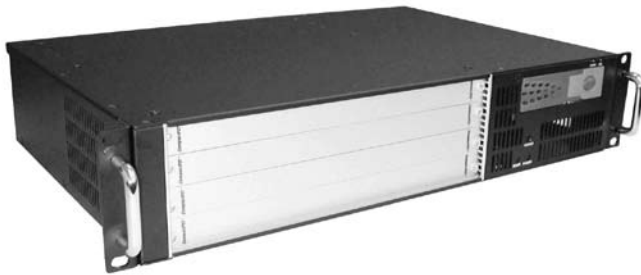

Specifications

- **EIA RS-310C 19" Rack-mount Standard**
- **Construction:** Rittal System & Heavy Duty Cold Rolled Electroplated Steel
- **Color:** Black (Standard), Beige or Custom
- **Support:** 4-Slot 64 bit 6U cPCI Backplane with H.110 Compatible pin Assignment on Peripheral Slot
- **Drive Capacity:** 1x 3.5" Swappable Trays
- **Power Supply(Optional):** 1U Single up to 400W ATX P/S (Rear Installation) Max. Depth 250mm
- **Cooling:** 2x (80mm = 42.5CFM ea.) Fans
- **Indicators:** LEDs for Power ON/OFF
- **Switch:** Power ON/OFF, System Reset
- **Dimensions (W x H x D):** 483x88x295mm(19"x3.5"x11.6")
- **Cuft:** 2.1
- **GW:** 10.1 kgs / 22.3 lbs
- **Carton Size(cm):** 59.3 x 44.5 x 22.6(23.4" x 17.5" x 8.9")
- **Product Applications:** High end Firewall , VPN ,IDS ,Traffic Management, Telecom

Dimension

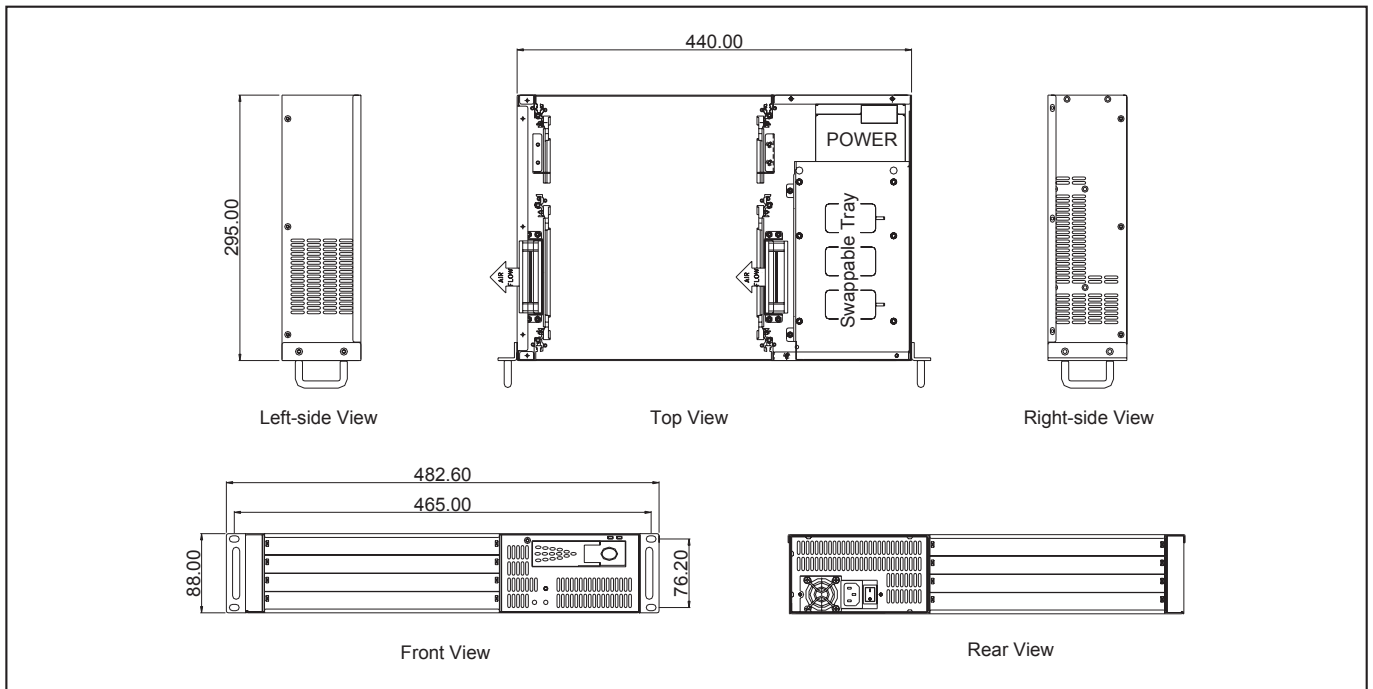

GHC-C03

3U Compact PCI



Specifications

- **EIA RS-310C 19" Rack-mount Standard**
- **Construction:** Rittal System & Heavy Duty Cold Rolled Electroplated Steel
- **Color:** Black (Standard), Beige or Custom
- **Support:** 5-slot 32/64 bit 6U cPCI H.110 Bus Backplane
- **Drive Capacity:** 1x Slim CD-ROM & 1x Slim FDD & 1x 3.5" Swappable Trays
- **Power Supply(Optional):** 2U Single 300W~320W ATX P/S
- **Cooling:** 1x (80mm = 42.5CFM ea.) Fan & 1x (90mm = 51CFM ea.) Fan
- **Indicators:** LEDs for Power ON/OFF
- **Switch:** Power ON/OFF, System Reset
- **Dimensions(WxHxD):** 483x133x296.2mm(19"x5.2"x11.7")
- **Cuft:** 2.5
- **GW:** 12.4 kgs / 27.3 lbs
- **Carton Size(cm):** 59.3 x 44.5 x 26.9(23.4"x17.5"x10.6")
- **Product Applications:** High end Firewall , VPN ,IDS ,Traffic Management, Telecom

Dimension

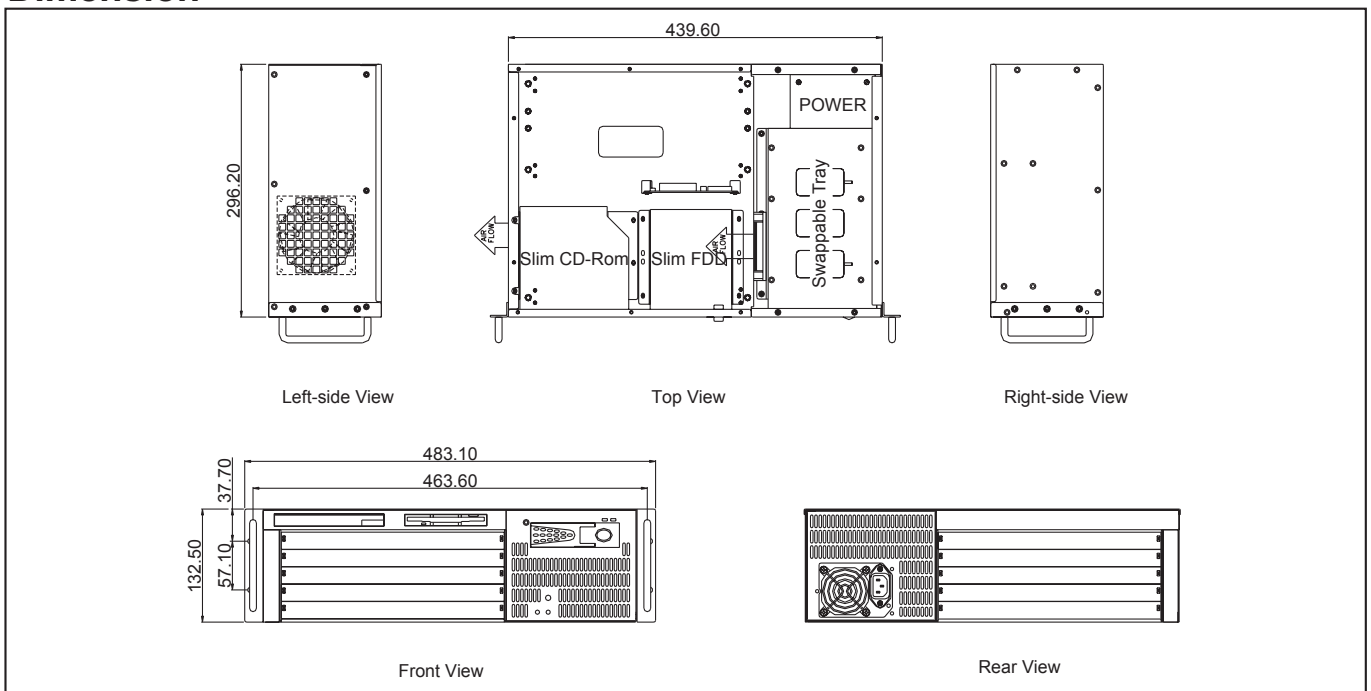

GHC-C04

4U Compact PCI



Specifications

- **EIA RS-310C 19" Rack-mount Standard**
- **Construction:** Rittal System & Heavy Duty Cold Rolled Electroplated Steel
- **Color:** Black (Standard), Beige or Custom
- **Support:** 7-slot 32/64 bit 6U cPCI H.110 Bus Backplane
- **Drive Capacity:** 1x Slim CD-ROM & 1x Slim FDD & 2x 3.5" Swappable Trays
- **Power Supply(Optional):** 2U Single 300W~320W ATX P/S
- **Cooling:** 1x (80mm = 42.5CFM ea.) Fan & 2x (90mm = 51CFM ea.) Fans
- **Indicators:** LEDs for Power ON/OFF
- **Switch:** Power ON/OFF, System Reset
- **Drive Capacity:** 483 x 177 x 296mm(19" x 7" x 11.7")
- **Cuft:** 2.9
- **GW:** 14.7 kgs / 32.4 lbs
- **Carton Size(cm):** 59.3 x44.5 x 31.4(23.4"x17.5"x12.4")
- **Product Applications:** High end Firewall , VPN ,IDS ,Traffic Management, Telecom

Dimension

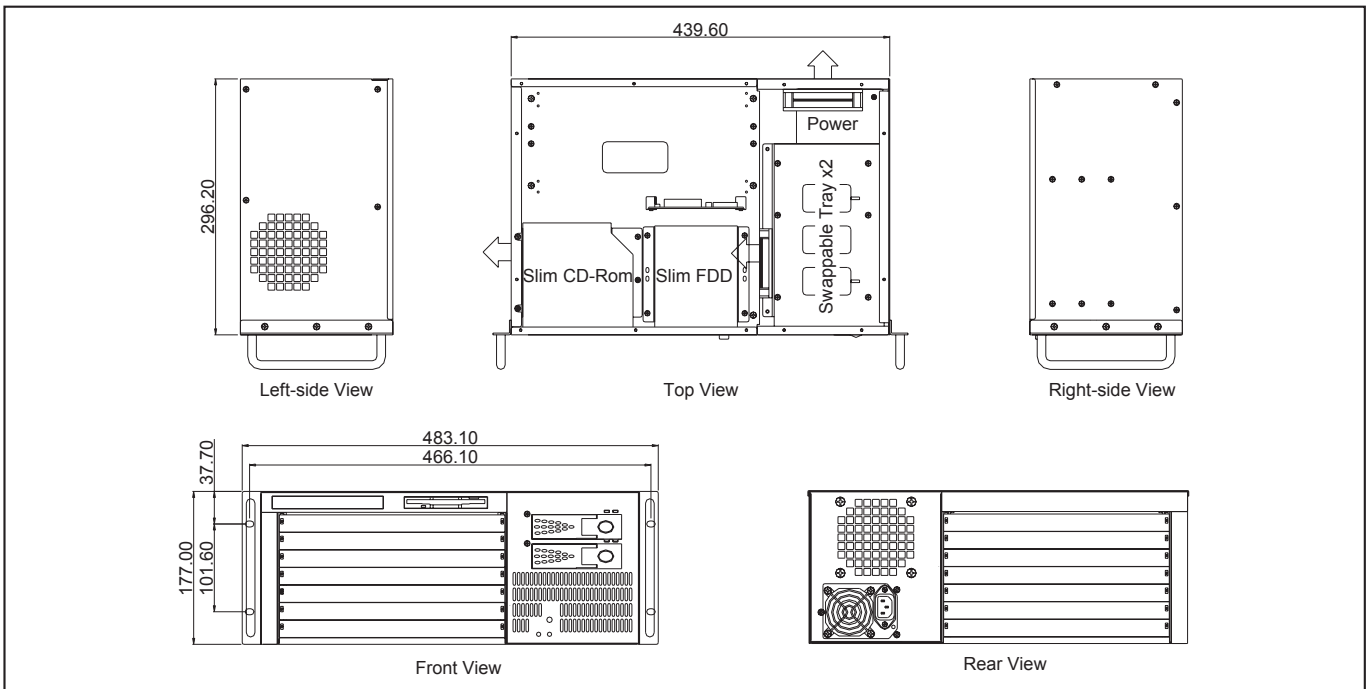

GHC-P03

8U Compact PCI



Specifications

- **EIA RS-310C 19" Rack-mount Standard**
- **Construction:** Rittal System & Heavy Duty Cold Rolled Electroplated Steel
- **Color:** Black (Standard), Beige or Custom
- **Support:** 9-slot High Density Server 6U cPCI Backplane
- **Drive Capacity:** 3x5.25" & 1x3.5"
- **Power Supply(Optional):** PS/2 Size Single 300~460W or Redundant 300~430W P/S
- **Cooling:** 2x(12cm) Blower(32.5CFM ea.) & 2x(9cm) (51CFM ea.) & 1x(12cm) (90CFM) Fans with Removable Air Filter
- **Thermal Management Card:** GHA-CO02
- **Indicators:** LEDs for Power ON/OFF
- **Switch:** Power ON/OFF, System Reset, Buzzer Reset
- **Dimensions (WxHxD):** 483 x 355 x 365mm (19"x14.0"x14.4")
- **Cuft:** 6.6
- **GW:** 21.0kgs / 46.3lbs
- **Carton Size(cm):** 63.5 x 50.2 x 58.5(25" x 19.8" x 23")

Dimension

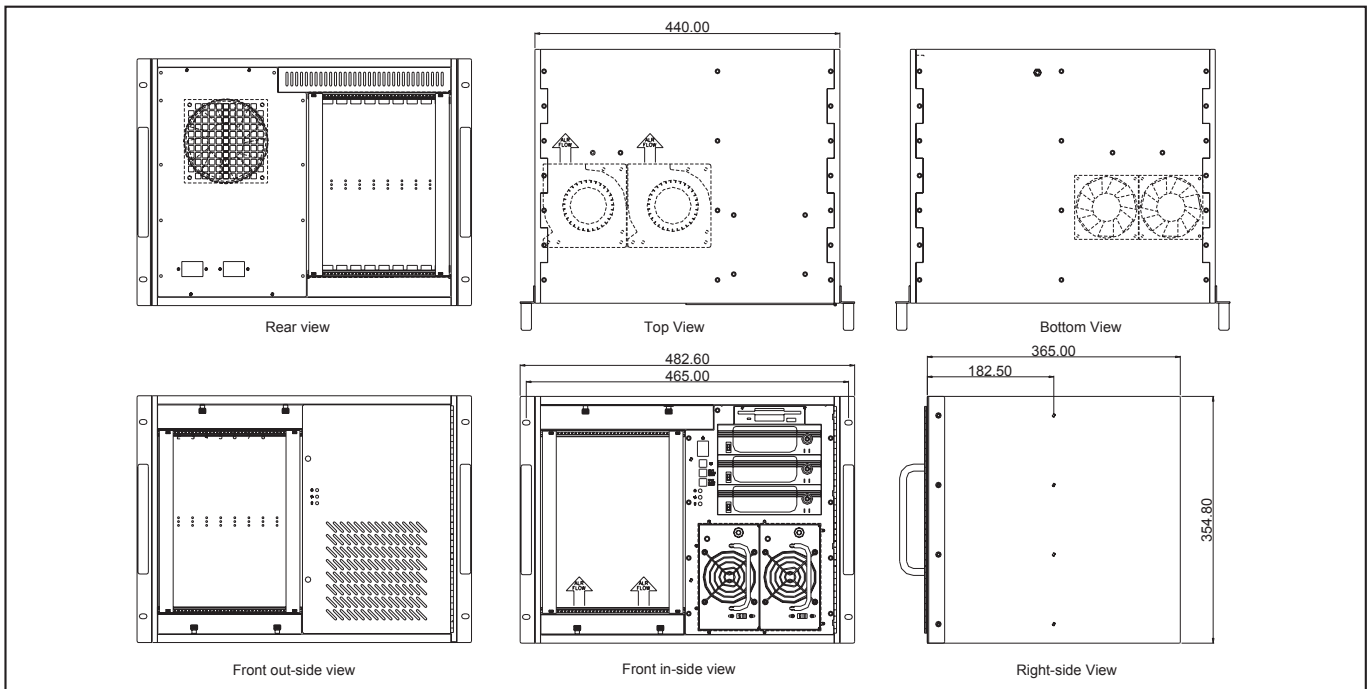

OEM PROJECTS

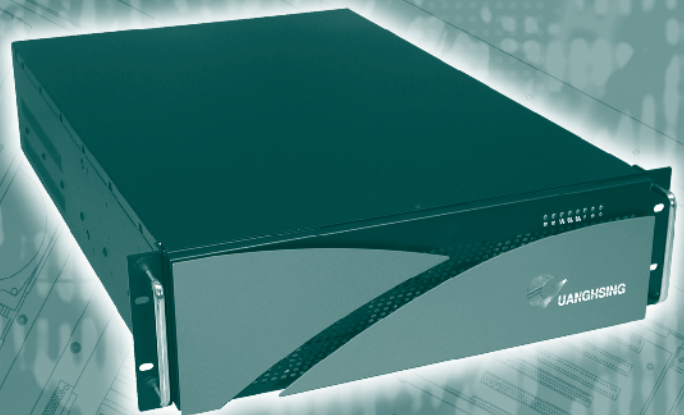
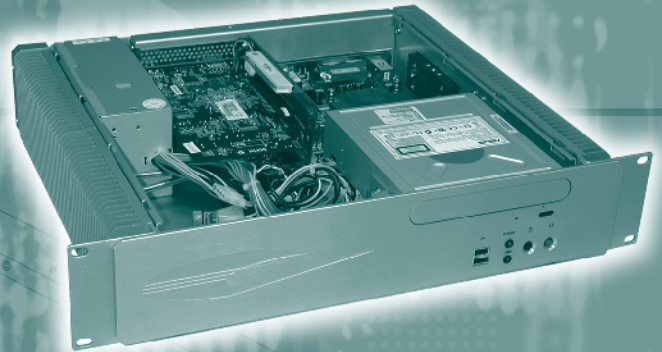

Compact PCI



GHR-190

1U Rackmount Storage Chassis



Specifications

- **EIA RS-310C 19" Rackmount Standard**
- **Construction:** Heavy Duty Cold Rolled Electroplated Steel
- **Color:** Black (Standard), Beige or Custom
- **Drive Capacity:** 4x 3.5" Swappable Trays
- **Drive Interface:** SATA, SCSI320 or SAS
- **Power Supply (Optional):** 1U Single up to 400W P/S (Mid Installation) Max. Depth 225mm
- **Cooling:** 6x (40 x 28mm = 15.3CFM ea.) Fans
- **Extension Port (Rear):** 1x SCSI Port
- **Thermal Management Card:** GHA-CO04
- **Indicators:** LEDs for Power ON/OFF, HDD Activity, Fan, Temperature
- **Switch:** Power ON/OFF Momentary (Rocker), System Reset
- **Dimensions (W x H x D):** 483 x 44 x 450mm (19" x 1.7" x 17.7")
- **Cuft:** 2.3
- **GW:** 10.3 kgs / 22.7 lbs
- **Carton Size(cm):** 61.5 x 17.9 x 60 (24.2" x 7.1" x 23.6")
- **Humidity:** 5% - 95% Non-condensing

Dimension

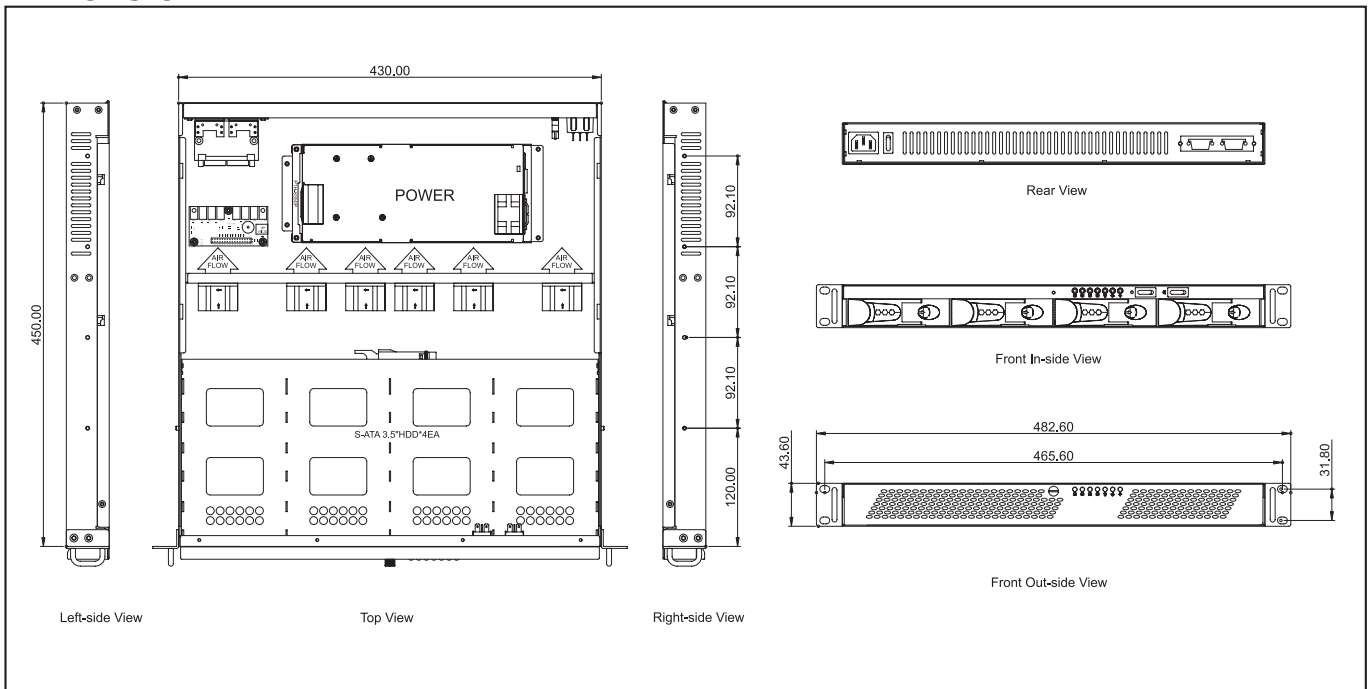

GHR-192

1U Rackmount Storage Chassis

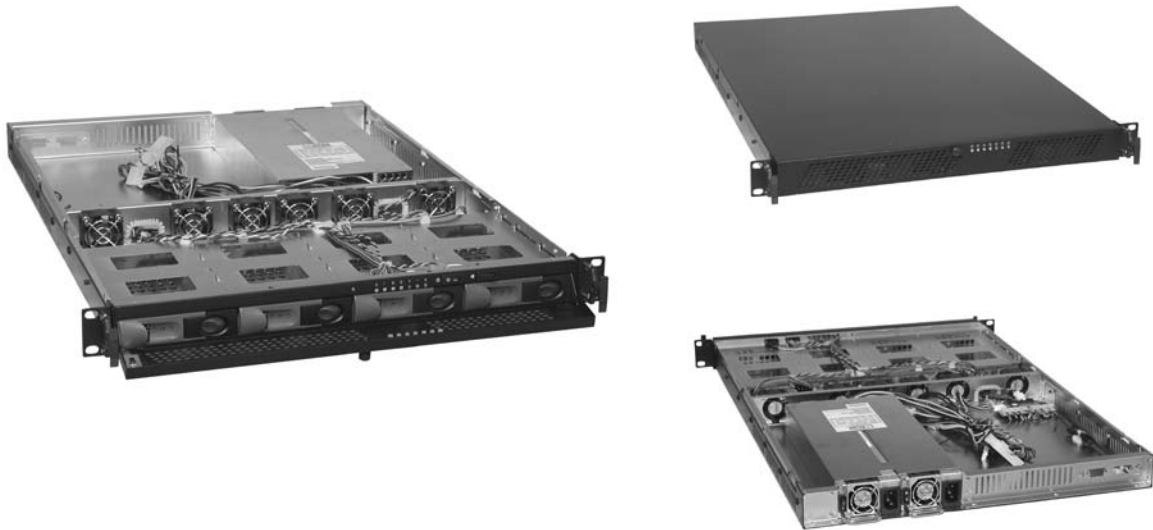

Specifications

- **EIA RS-310C 19" Rackmount Standard**
- **Construction:** Heavy Duty Cold Rolled Electroplated Steel
- **Color:** Black (Standard), Beige or Custom
- **Drive Capacity:** 4x 3.5" Swappable Trays
- **Drive Interface:** SATA, SCSI320 or SAS
- **Power Supply (Optional):** 1U Redundant up to 300W P/S (Rear Installation) Max. Depth 280mm
- **Cooling:** 6x (40 x 28mm = 15.3CFM ea.) Fans
- **Extension Port (Rear):** 1x SCSI Port
- **Thermal Management Card:** GHA-CO04
- **Indicators:** LEDs for Power ON/OFF, HDD Activity, Fan, Temperature
- **Switch:** Power ON/OFF Momentary (Rocker), System Reset
- **Dimensions (W x H x D):** 483 x 44 x 610mm (19" x 1.7" x 24")
- **Cuft:** 2.3
- **GW:** 10.7 kgs / 23.6 lbs
- **Carton Size(cm):** 61.5 x 17.9 x 76 (24.2" x 7.1" x 29.2")
- **Humidity:** 5% - 95% Non-condensing

Dimension

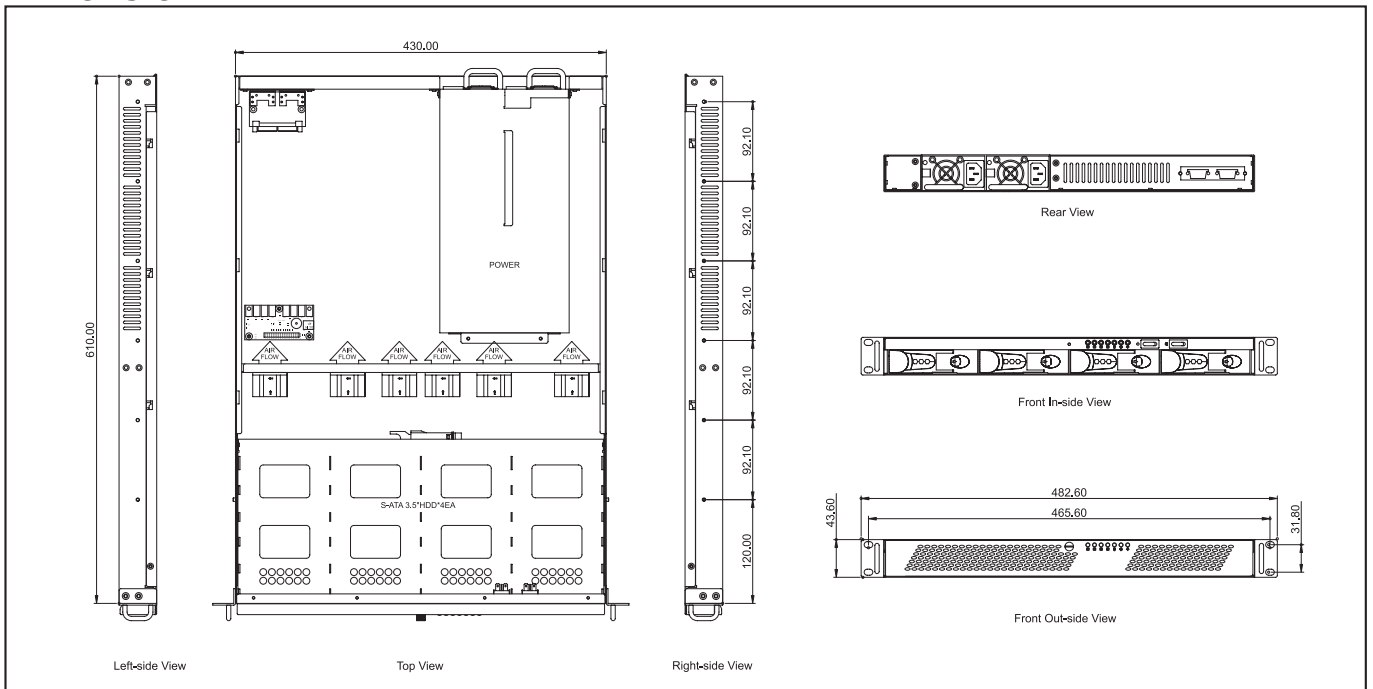

GHR-219

2U Rackmount Storage Chassis



Specifications

- **EIA RS-310C 19" Rackmount Standard**
- **Construction:** Heavy Duty Cold Rolled Electroplated Steel
- **Color:** Black (Standard), Beige or Custom
- **Drive Interface:** SCSI 320
- **Drive Capacity:** 9xHot Swappable SCSI Trays
- **Power Supply(Optional):** PS/2 Size Single 250~400W P/S or Redundant 300~400W P/S
- **Cooling:** 4x (80mm = 42.5CFM ea.) Fans
- **Thermal Management Card:** GHA-CO02
- **Indicators:** LEDs for Power ON/OFF, HDD Activity, Fan, Temperature
- **Switch:** Power ON/OFF, System Reset
- **Dimensions(WxHxD):** 483 x 88 x 450mm(19"x3.5"x17.7")
- **Cuft:** 3.2
- **GW:** 13.7 kgs / 30.2 lbs
- **Carton Size(cm):** 63 x 24.8 x 57.4 (24.8" x 9.8" x 22.6")

Dimension

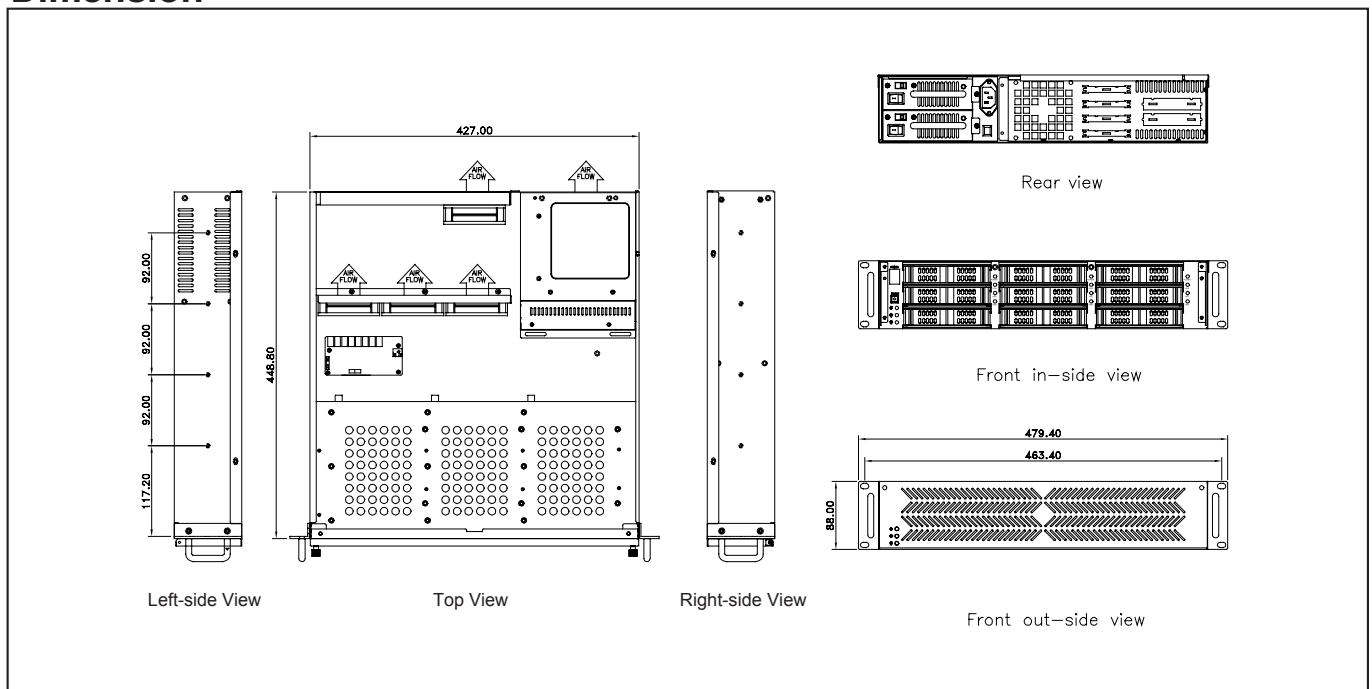

GHR-290

2U Rackmount Storage Chassis

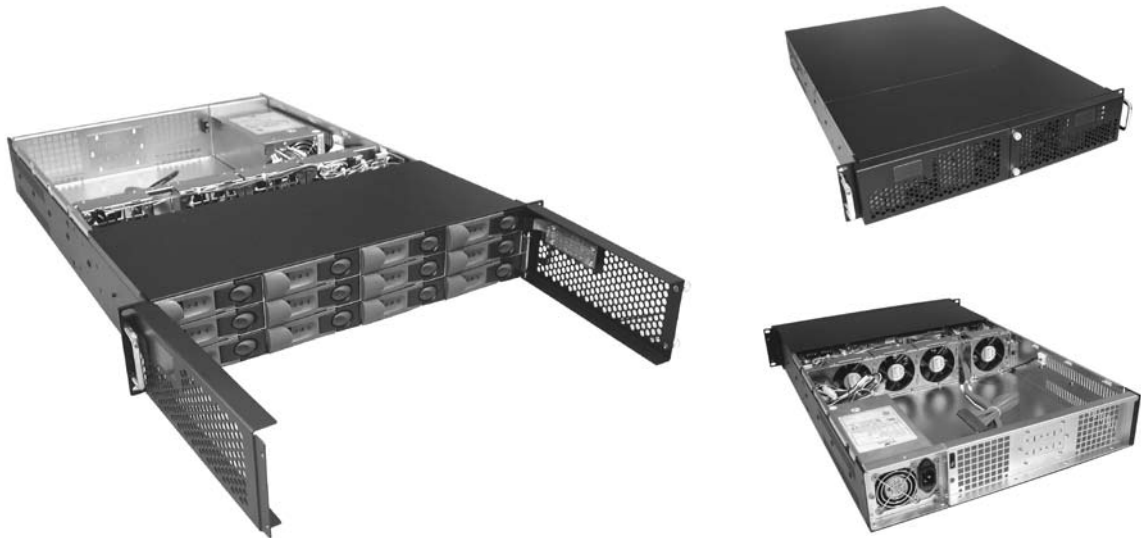

Specifications

- **EIA RS-310C 19" Rackmount Standard**
- **Construction:** Heavy Duty Cold Rolled Electroplated Steel
- **Color:** Black (Standard), Beige or Custom
- **Drive Capacity:** 12x 3.5" Swappable Trays
- **Drive Interface:** SATA, SCSI320, Multilane SATA or SAS
- **Power Supply (Optional):** 2U Single up to 600W or 2U Redundant up to 500W ATX P/S(Rear Installation) Max. Depth 300mm
- **Cooling:** 4x (80mm = 42.5CFM ea.) Fans
- **Front Door:** Double Horizontal Doors With 2 Thumbscrews
- **Riser Card:** GHP-R0301 (32bit Ribbon) or GHP-R0304 (64bit Ribbon) (Optional)
- **Thermal Management Card:** GHA-CO08
- **Indicators:** LEDs for Power ON/OFF, HDD Activity, Fan, Temperature, LAN
- **Switch:** Power ON/OFF Momentary (Pushbutton), System Reset, Buzzer Reset
- **Dimensions (W x H x D):** 483 x 88 x 650mm (19" x 3.5" x 25.6")
- **Cuft:** 4.4
- **GW:** 17.1 kgs / 37.7 lbs
- **Carton Size(cm):** 58.8 x 25.5 x 82.5 (23.1" x 10" x 32.5")
- **Humidity:** 5% - 95% Non-condensing

Dimension

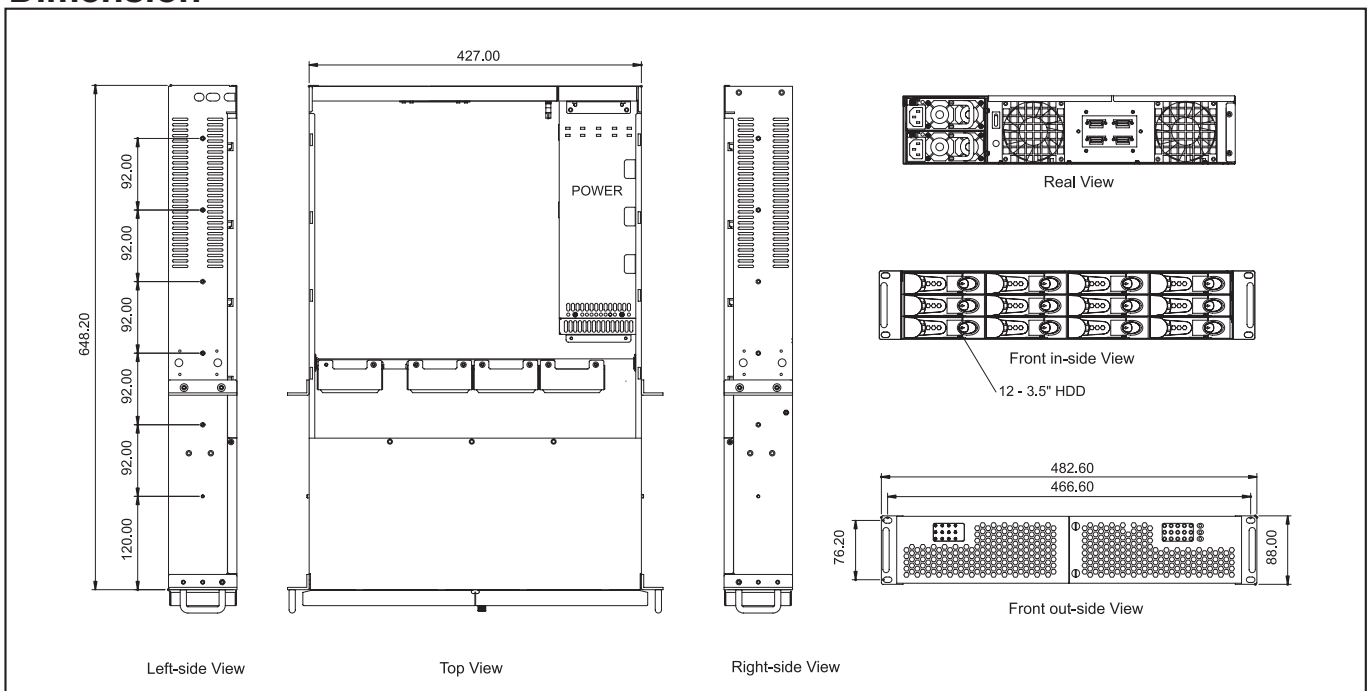

GHR-390

3U Rackmount Storage Chassis



Specifications

- **EIA RS-310C 19" Rackmount Standard**
- **Construction:** Heavy Duty Cold Rolled Electroplated Steel
- **Color:** Black (Standard), Beige or Custom
- **Drive Capacity:** 16x 3.5" Swappable Trays
- **Drive Interface:** SATA, SCSI320, SAS or SAS Expander
- **Power Supply (Optional):** PS/2 Single up to 700W or Mini Redundant up to 500W P/S (Rear Installation) Max. Depth 220mm
- **Cooling:** 6x (92mm = 51CFM ea.) Fans
- **Connector Port (Front):** 2xUSB Ports (Optional)
- **Thermal Management Card:** GHA-CO04
- **Indicators:** LEDs for Power ON/OFF, HDD Activity, Fan, Temperature
- **Switch:** Power ON/OFF , System Reset
- **Dimensions (W x H x D):** 483 x 133 x 507mm (19" x 5.2" x 20")
- **Cuft:** 4.2
- **GW:** 18.1 kgs / 39.9 lbs
- **Carton Size(cm):** 58.8 x 28.5 x 70.3 (23.1" x 11.2" x 27.7")
- **Humidity:** 5% - 95% Non-condensing

Dimension

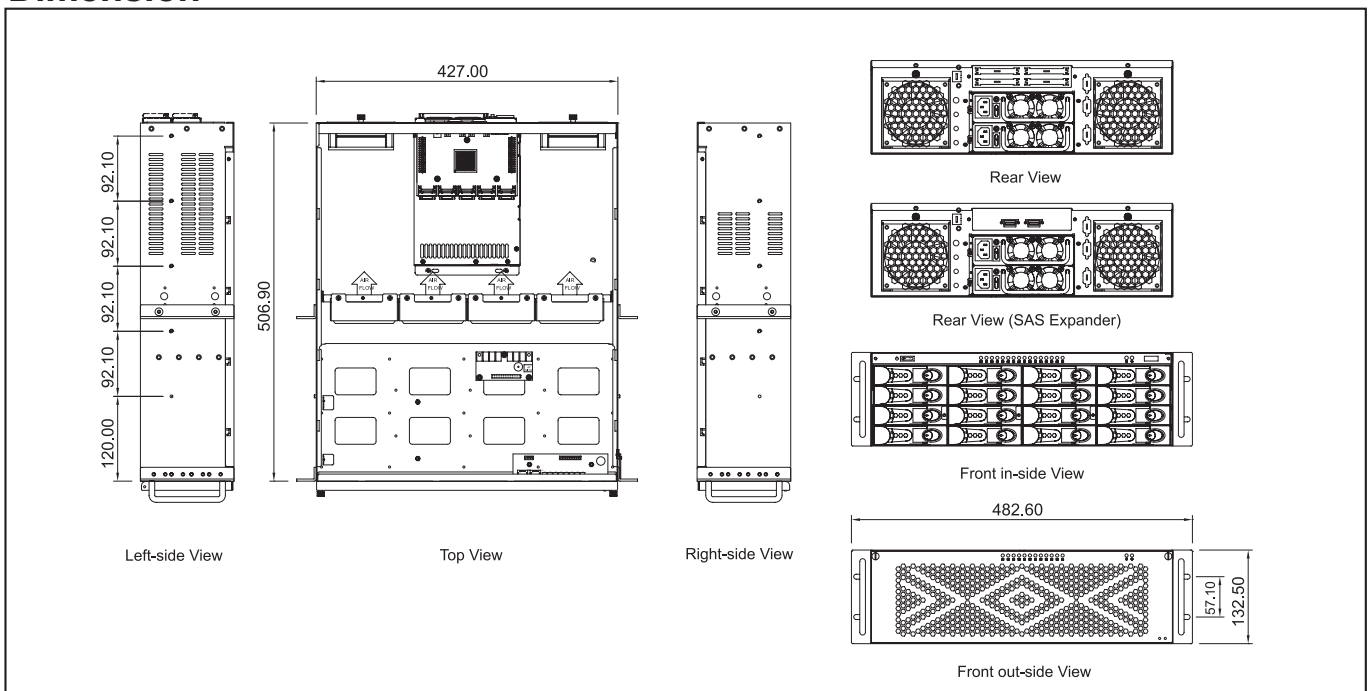

GHR-422

4U Rackmount Storage Chassis



Specifications

- **EIA RS-310C 19" Rackmount Standard**
- **Construction:** Heavy Duty Cold Rolled Electroplated Steel
- **Color:** Black (Standard), Beige or Custom
- **Drive Capacity:** 9x 5.25"(Vertical)
- **Power Supply(Optional):** PS/2 Size Single 230~460W P/S or Redundant 300~400W P/S
- **Cooling:** 2x (90mm = 51CFM ea.) Fans & 1x (90mm = 51CFM ea.) Fan (Optional)
- **Thermal Management Card:** CHA-CO04
- **Indicators:** LEDs for Power ON/OFF, HDD Activity, Fan, Temperature
- **Switch:** Power ON/OFF, System Reset, Buzzer Reset
- **Dimensions(WxHxD):** 483 x 177 x 510 mm (19" x 7" x 20.1")
- **Cuft:** 4.9
- **GW:** 16.0 kgs / 35.3 lbs
- **Carton Size(cm):** 59.1 x 34 x 68.8(23.3" x 13.4" x 27.1")

Dimension

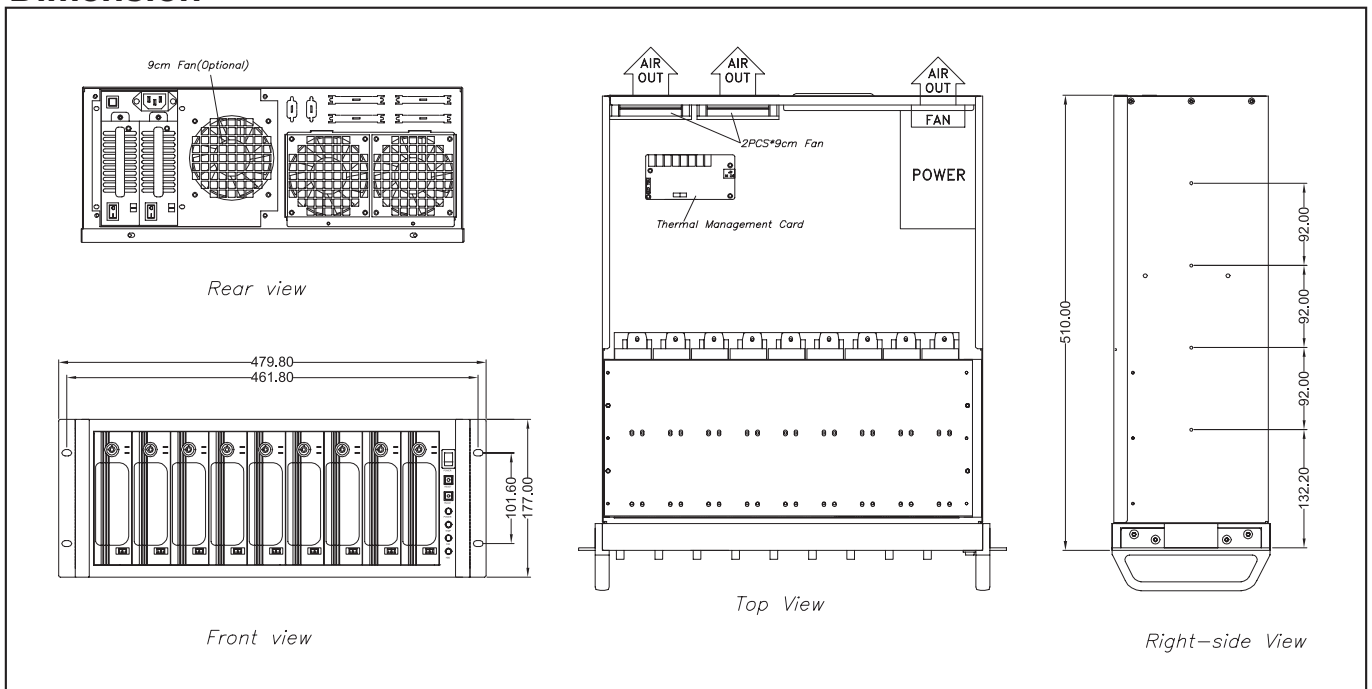

GHS-1500

Server Case



Specifications

- **Server / RAID case or 19" Rack Mounted**
- **Construction:** Heavy Duty Cold Rolled Electroplated Steel
- **Color:** Black or Custom Design
- **Support EATX M/B(Max. to 12"x13")**
- **Support 14-slot Passive Backplane**
- **Drive Capacity:** 15x5.25"
- **Power Supply(Optional):** PS/2 Size Single up to 700W or Redundant 300~400W P/S or Triple Redundant 800+400W P/S
- **Cooling:** 5x(9cm) Fans(51CFM ea.)
- **Indicators:** LEDs for Power ON/OFF, HDD Activity, Fan, Temperature
- **Switch:** Power ON/OFF, System Reset, Buzzer Reset
- **Lockable Security Access and Lockable Casters**
- **Dimensions(WxHxD):** 410x416x710mm(16.2"x16.4"x28")
- **Cuft:** 9.3
- **GW:** 34 kgs / 75 lbs
- **Carton Size(cm):** 54.8x55.8x85.7(21.6"x22"x33.7")



GHA-1520

GHS-1500,GHS-2000 Rackmount Tray (Optional)

GHS-2000

Server Case

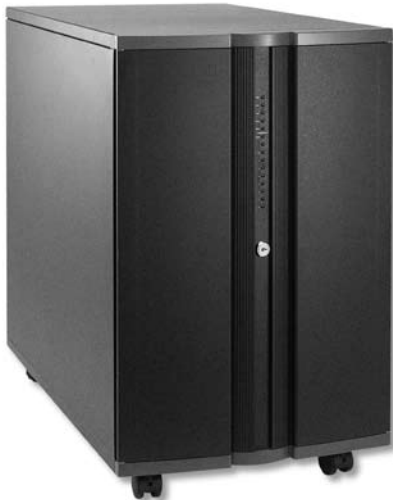

Specifications

- Server / RAID case or 19" Rack Mounted
- Construction: Heavy Duty Cold Rolled Electroplated Steel
- Color: Black or Custom Design
- Support EATX M/B(Max. to 16"x13")
- Support 20-slot Passive Backplane
- Drive Capacity: 23x 5.25"
- Power Supply(Optional): PS/2 Size Single up to 700W or Redundant 300~600W P/S or Triple Redundant 800+400W P/S
- Cooling: 8x (90mm = 51CFM ea.) Fans & 2x (120mm = 108CFM ea.) Fans
- Indicators: LEDs for Power ON/OFF, HDD Activity, Fan, Temperature
- Switch: Power ON/OFF, System Reset, Buzzer Reset
- Thermal Management Card Installed
- Lockable Security Access and Lockable Casters
- Dimensions(WxHxD): 410 x 600 x 710mm(16.2" x 23.6" x 28")
- Cuft: 12.2
- GW: 44 kgs / 97 lbs
- Carton Size(cm): 54.8 x 73.6 x 85.7(21.6" x 29" x 33.7")



GHA-1520

GHS-1500,GHS-2000 Rackmount Tray (Optional)

GHK-325

Hot-Swappable Disk Array



Specifications

- **Mounted into a 3.5" Drive Space**
- **Construction:** Heavy Duty Cold Rolled Electroplated Steel
- **Color:** Black (Standard), or Custom
- **Drive Capacity:** 2x 2.5" Hot Swappable Drive Trays
- **Drive Interface:** SATA
- **Powered by 4pin Connector from the P/S**
- **Indicators:** LEDs for Power ON/OFF, HDD Activity
- **Dimensions (W x H x D):** 100 x 25 x 128mm (3.9" x 1" x 5")
- **Cuft:** 0.1
- **GW:** 0.7 kgs / 1.5 lbs
- **Carton Size(cm):** 20 x 4.5 x 20 (7.9" x 1.8" x 7.9")
- **Humidity:** 5% - 95% Non-condensing

GHK-425

Hot-Swappable Disk Array



Specifications

- **Mounted into a 5.25" Drive Space**
- **Construction:** Heavy Duty Cold Rolled Electroplated Steel
- **Color:** Black (Standard), or Custom
- **Drive Capacity:** 4x 2.5" Hot Swappable Drive Trays
- **Drive Interface:** SATA, SCSI320 or SAS
- **Powered by 4pin Connector from the P/S**
- **Cooling:** 1x (40mm) Internal Fan
- **Thermal Management Function Installed**
- **Indicators:** LEDs for Power ON/OFF, Individual HDD Activity, Temperature
- **Switch:** Buzzer Reset
- **Dimensions (W x H x D):** 146 x 40.8 x 198mm (5.8" x 1.6" x 7.8")
- **Cuft:** 0.3
- **GW:** 1.5 kgs / 3.3 lbs
- **Carton Size(cm):** 22 x 12.5 x 27 (8.7" x 4.9" x 10.6")
- **Humidity:** 5% - 95% Non-condensing

GHK-431

Hot-Swappable Disk Array



Specifications

- **Mounted into a 3x 5.25" Drive Space**
- **Construction:** Heavy Duty Cold Rolled Electroplated Steel
- **Color:** Black (Standard), or Custom
- **Drive Capacity:** 4x 3.5" Hot Swappable Drive Trays
- **Drive Interface:** SATA, SCSI320 or SAS
- **Powered by 4pin Connector from the P/S**
- **Cooling:** 2x (60mm) Internal Blower Fans
- **Indicators:** LEDs for Power ON/OFF, Individual HDD Activity
- **Dimensions (W x H x D):** 146 x 128 x 187mm (5.8" x 5" x 7.4")
- **Cuft:** 0.7
- **GW:** 3.8 kgs / 8.4 lbs
- **Carton Size(cm):** 26 x 24 x 31 (10.3" x 9.5" x 12.2")
- **Humidity:** 5% - 95% Non-condensing

GHK-541

Hot-Swappable Disk Array



Specifications

- **Mounted into a 4x 5.25" Drive Space**
- **Construction:** Heavy Duty Cold Rolled Electroplated Steel
- **Color:** Black (Standard), or Custom
- **Drive Capacity:** 5x 3.5" Hot Swappable Drive Trays
- **Drive Interface:** SATA, SCSI320 or SAS
- **Powered by 4pin Connector from the P/S**
- **Cooling:** 2x (60mm) Internal Blower Fans
- **Indicators:** LEDs for Power ON/OFF, Individual HDD Activity
- **Dimensions (W x H x D):** 146 x 171.5 x 187mm (5.8" x 6.8" x 7.4")
- **Cuft:** 0.8
- **GW:** 4.4 kgs / 9.7 lbs
- **Carton Size(cm):** 26 x 28 x 31 (10.3" x 11" x 12.2")
- **Humidity:** 5% - 95% Non-condensing

Accessories

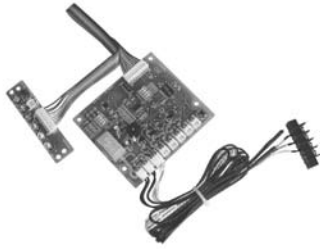

GHA-C001

- Two Sets of Temperature Sensor
- Three Level Temperature Setting(40°C, 50°C, 60°C)
- Front Panel LEDs System Status Display
- External Alarm Connector And Internal Buzzer
- 2-Pin Fan Failure Detect and Control

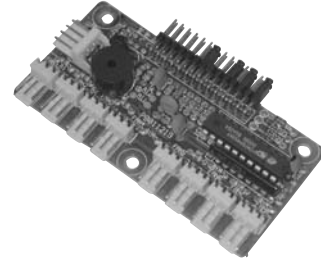

GHA-C004

- Two Sets of Temperature Sensor
- Three Level Temperature Setting(40°C, 50°C, 60°C)
- Front Panel LEDs System Status Display
- Internal Buzzer
- 3-Pin Fan Failure Detect and Control

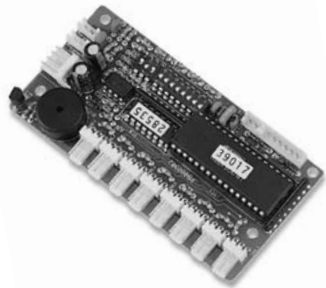

GHA-C002

- Two Sets of Temperature Sensor
- Three Level Temperature Setting(40°C, 50°C, 60°C)
- Front Panel LEDs System Status Display
- Internal Buzzer
- 3-Pin Fan Failure Detect and Control



GHA-C005

- Four Set of Temperature and Fan Dip Switch Setting and Connectors for Temperature Control
- LEDs System Status Display(Normal-Green,Abnormal-Red)
- 2 - Pin Fan Connectors for Fan Detect and Status Display
- 3 - Pin Temperature Connectors for Temperature Detect
- Three Connectors (CN) for DC Input, Power and HDD LED Input Respectively
- Four Temperature Limit Adjust Connectors/Settings

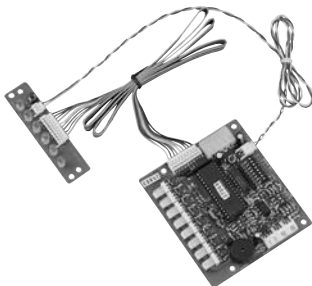

GHA-C003

- Two Sets of Temperature Sensor
- Three Level Temperature Setting(40°C, 50°C, 60°C)
- Front Panel LEDs System Status Display
- Internal Buzzer
- 3-Pin Fan Failure Detect and Control



GHA-BRM 1

- B04, B08 Rackmount Application

Accessories



GHA-SL20-1U/ SL24-1U

- Zinc Plated
- Mounting by Screw Application in General Frame
- Heavy Duty Metal Slide Rail
- GHA-SL20-1U: 20" Slide Rail for 19" 1U Chassis
- GHA-SL24-1U: 24" Slide Rail for 19" 1U Chassis



GHA-SL20/ SL24/ SL26

- Zinc Plated
- Mounting by Screw Application in General Frame
- Heavy Duty Metal Slide Rail
- GHA-SL20: 20" Slide Rail for 19" Chassis
- GHA-SL24: 24" Slide Rail for 19" Chassis
- GHA-SL26: 26" Slide Rail for 19" Chassis



RL-CC1001-99-0104/CC3001-00-0240/CC3001-00-0260

- Mounting by Screw Application in General Frame
- Heavy Duty Metal Slide Rail
- RL-CC1001-99-0104: 30" Full Extension Slide Rail for 19" Chassis(Supports up to 175 lbs)
- RL-CC3001-00-0240: 24" Slide Rail for 19" Chassis
- RL-CC3001-00-0260: 26" Slide Rail for 19" Chassis

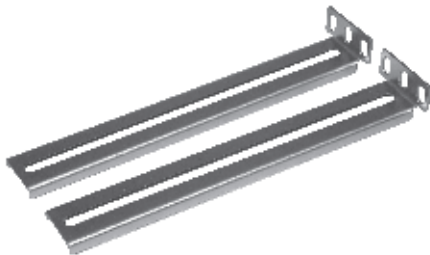

GHA-RSP-1U

- Rackmount Rear Supporter
- For 1U Rackmount Chassis

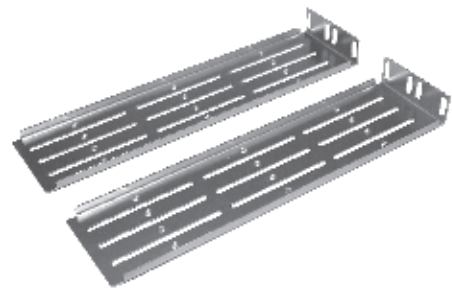

GHA-RSP-2U

- Rackmount Rear Supporter
- For 2U and 2U up Rackmount Chassis

Accessories



GHA-H199

- "L" shape Bracket for 3.5" Drive



GHA-H211

- Holder Bracket for 2 x 3.5" Drives



GHA-H300

- Holder Bracket for 3.5" Drive



GHA-H311

- Holder Bracket for 3x 3.5" Drives

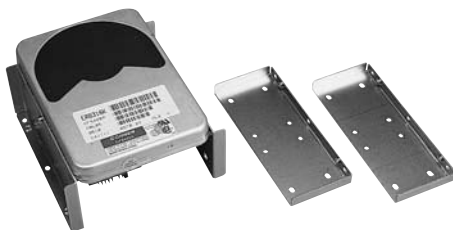

GHA-H432

- "L" Shape Bracket for 2x3.5" Drive



GHA-H414

- Holder Bracket for 3.5" Drive

Accessories



GHA-H431

- "L" Shape Bracket for 3.5" Drive

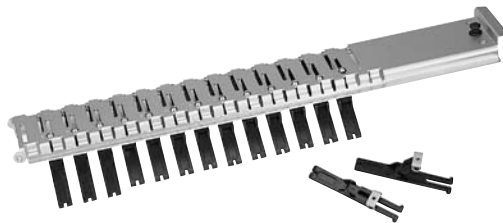

GHA-TE01

- Adjustable Trigger Type Hold Down Bar



GHA-410

- Adjustable 2 Section Type Hold Down Bar

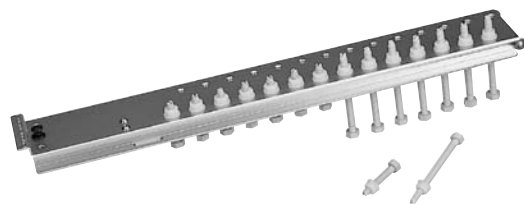

GHA-YT01

- Adjustable Screw Type Hold Down Bar



GHA-418

- Adjustable Flipper Type Hold Down Bar



GHA-SR242

- Brand: Mitsumi
- Model: SR242(24xslim CD-ROM)

Accessories



GHA-D353

- Brand: Mitsumi
- Model: D353F3 (Slim FDD, 1.44MB, 3 Mode)



GHA-H280

- Holder Bracket for GHI-280/281/282/283 Extra Drive



SDW-082S

- Slim DVD Rewritable Drive With IDE Adaptor
- Support any OS Systems Including Linux, Win2000, WinXP, Solaris.
- 8X DVD+R, 4X DVD-R, 4X DVD+RW, 4X DVD-RW, 24X CD-R, 10X CD-RW.
- 8X DVD/ 24X CDR as Reading Speed.
- Master/ Slave Adjustable (Default is Master).
- Only Black Color Available.



GHA-H380

- Holder Bracket for GHI-380/381 Extra 1 or 2x3.5" Drives



SDR-083

- Slim DVD-ROM With IDE Adaptor
- Support any OS System including Linux, Win2000, WinXP, Solaris.
- DVD 8X/ CD 24X, 12.7mm Drawer, DVD-Multi R, SMART-X, DFS mechanism.
- Master/ Slave Adjustable (Default is Master).
- Only Black Color Available.



GHA-H480

- Holder Bracket for GHI-480/481 Extra 2x3.5" Drives

Accessories

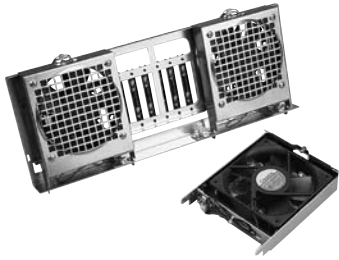

GHA-F123

- Hot-Swappable Ball Bearing Fan Set
- 3x(12cm) DC Fans, 90CFM ea.
- 5U Chassis Application

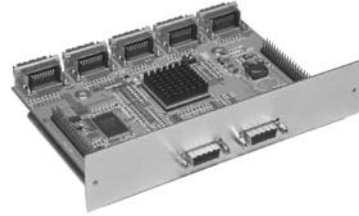

GHA-SAS-A

- SAS Expander
- Support up to 20pcs HDD
- Infiniband 25 Pin Connector



GHA-F418

- Extra Cooler for GH-418 Model
- 3 Sets of 12V DC Blower, 32CFM ea.
- Dimension: 108x306x28mm

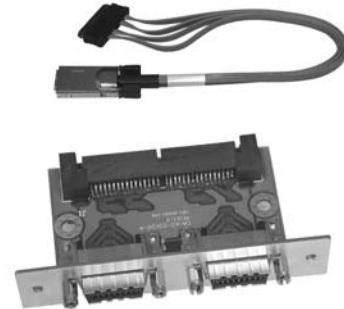

GHA-SAS-B

- SAS Adapter With SCSI Mounting Plate
- Infiniband 25 Pin to Multilane 32 Pin Cable (500mm)

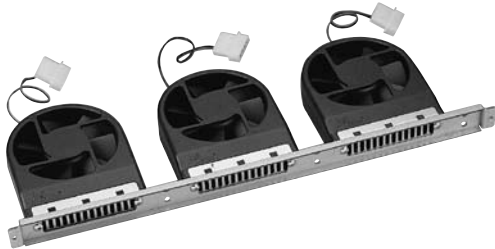

GHA-F520

- Extra Cooler for GH-5U Chassis
- 3 Sets of 12V DC Blower, 32CFM ea.
- Dimension: 108x372x28

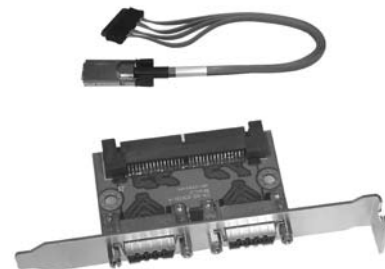

GHA-SAS-C

- SAS Adapter With PCI Mounting Plate
- Infiniband 25 Pin to Multilane 32 Pin Cable (500mm)

Accessories



GHA-4HL

- Handle with "L" shape Bracket for 4U Rackmount Chassis



GHA-3UA/4UA

- Aluminum Handle for 3U Chassis (GHA-3UA)
- Aluminum Handle for 4U Chassis (GHA-4UA)



GHA-4UL

- "L" Shape Bracket for 4U Rackmount Chassis

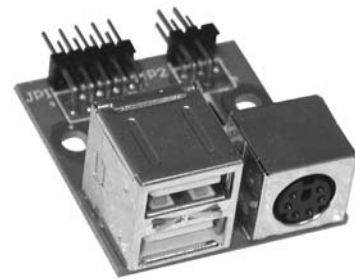

GHA-K005

- Adapter For 2xUSB & 1xPS2



GHA-4UH

- Chromium-Plated Handle for 4U Chassis



GHA-K006

- Adapter For 2 USB

Accessories



GHA-K002

- Adapter For Slim CD-ROM & Slim FDD



GHA-K007

- Adapter For Slim CD-ROM to SATA
- Support Slave and Master CD-ROM by Jumper Setting



GHA-K003

- Adapter For Slim CD-ROM



GHA-K008

- Adapter For Slim CD-ROM(Mini-SATA) to SATA



GHA-K004

- Adapter For Slim FDD



GHA-K009

- Adapter For Slim CD-ROM to USB

Accessories



GHA-690-A

- Extra Bracket for GHI-690/691 Chassis
- Cooling: 4 x (40 x 28mm = 15.3CFM ea.) Fans

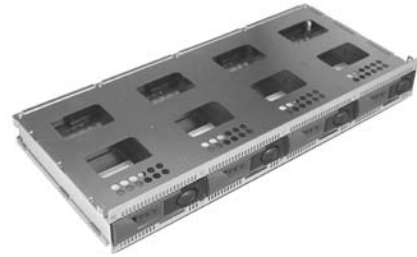

GHA-690-D

- Extra Bracket for GHI-690/691 Chassis
- Drive Capacity: 4 x 3.5" Swappable Trays
- Drive Interface: SATA, SCSI 320 or SAS



GHA-690-B

- Extra Bracket for GHI-690/691 Chassis
- Drive Capacity: 2 x 5.25" CD-ROM



GHA-M06

- 6.4" TFT LCD Module
- Resoluitien: 640 x 480
- Luminance: 230 cd/m2
- Switch: Power, Menu



GHA-690-C

- Extra Bracket for GHI-690/691 Chassis
- Drive Capacity: 1 x 5.25" CD-ROM & 2 x 3.5"HDD
- Cooling: 2 x (92mm = 30.5 CFM ea.) Blowers

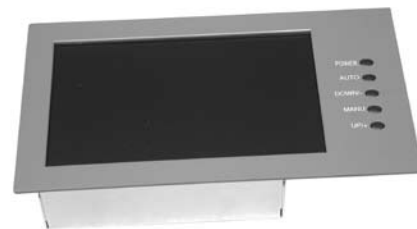

GHA-M07

- 7" TFT LCD Module
- Resoluitien: 640 x 480
- Luminance: 230 cd/m2
- Switch: Power, Menu

Accessories

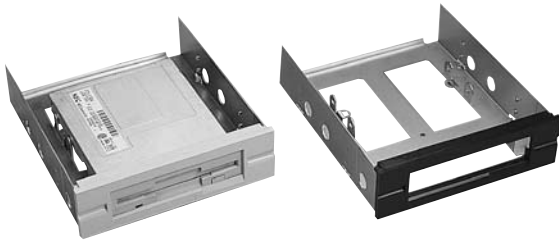

GHA-FM01

- Drive Adapters
To mount a 3.5" Drive Into one 5.25" Drive Bay



GHA-FM05/FH05

- Drive Loading Enclosure
- Concise in 5.25" Drive Bay
- FM05:1xSlim CD-ROM & 1xSlim FDD Drive Bay
- FH05:1xSlim CD-ROM & 1x2.5" HDD Drive Bay



GHA-FM03/FH03

- Drive Loading Enclosure
- Concise in 5.25" Drive Bay
- FM03:1xSlim CD-ROM & 1x3.5" FDD Drive Bay
- FH03:1xSlim CD-ROM & 1xSlim FDD & 1x2.5" Drive Bay
- Optional 2x USB & 1x K/B Connector



GHA-FM06

- Drive Loading Enclosure
- Concise in 5.25" Drive Bay
- 3.5" Drive Space with IDE/SATA/SCSI320/SAS Backplane (Optional)



GHA-FM04/FH04

- Drive Loading Enclosure
- Concise in 5.25" Drive Bay
- FM04:1xSlim CD-ROM & 1xSlim FDD & 1x2.5" Drive Bay
- FH04:1xSlim CD-ROM & 1x3.5" HDD Drive Bay



GHA-FM07

- Drive Loading Enclosure
- Concise in 5.25" Drive Bay
- 2xSlim CD-ROM Drive Bay

Accessories



GHA-FM09

- Drive Adapter
- To Mount a 2.5" Swappable Drive Into one 3.5" Drive Bay
- Interface: SATA, PATA



GHA-FM801

- Drive Loading Enclosure
- Concise in 3.5" Drive Bay
- Support one 3.5" Drive



GHA-F10

- Drive Adapter
- To Mount a 3.5" Swappable Drive Into one 5.25" Drive Bay
- Interface: PATA, SATA, SCSI320, or SAS



GHA-H01

- Drive Adapter
- To Mount a 3.5" HDD Into one 5.25" Drive Bay With 2x(40x20mm=7CFM ea.) Fans



GHA-F11

- Drive Loading Enclosure
- Concise in 5.25" Drive Bay
- 1x3.5"FDD & 1x2.5"HDD Drive Bay



GHA-1520

- GHS-1500, GHS-2000 Rackmount Tray

Accessories



GHA-DVR-17H

- For 4U up to 8U Chassis
- Support 17 BNC Connectors



GHA-BW256

- for 2U Chassis
- Support 2 Horizontal Expansion Slots for fitting on the 5th & 6th M/B Slot



GHA-BW205

- for 2U Chassis
- Support 2 Horizontal Expansion Slots for fitting on the 5th M/B Slot



GHA-BW305

- for 2U Chassis
- Support 3 Horizontal Expansion Slots for fitting on the 5th M/B Slot



GHA-BW206

- for 2U Chassis
- Support 2 Horizontal Expansion Slots for fitting on the 6th M/B Slot



GHA-BW306

- for 2U Chassis
- Support 3 Horizontal Expansion Slots for fitting on the 6th M/B Slot

Passive Backplane

Model	Slot of Backplane			Power Connector			Chassis
	PCIMG	PCI	PCIe	ISA	AT	ATX	
GHP-B2SD	1	1			X		GH-199B
GHP-G1UG1	1	1		1		X	GHI-100/101
GHP-AD3S2	1	2				X	GHI-100/101
GHP-B4PS1	1	4			X		GH-288SR
GHP-AD6S4	1	4		1	X	X	GHI-200/GH-288SR
GHP-B6SD	1	2		3	X		GH-288SR
GHP-P2UP4	2	4			X	X	GHI-200/GH-288SR
GHP-2004				4	X	X	GHB-B04
GHP-2204	2	3			X	X	GHB-B04
GHP-2006				6	X	X	GHB-060
GHP-2206	2	4		1	X	X	GHB-060
GHP-2308	1	3		4	X	X	GHB-B08
GHP-2008				8	X		GH-400S/402SR/403SR/410SR/411SR/414SR
GHP-2208	2	4		3	X	X	/416SR/418SR/419SR/431SR/GHB-080
GHP-2014				14	X	X	
GHP-2214	2	4		8	X	X	GH-400SR/402SR/403SR/410SR/411SR/414SR/
GHP-P14P4	2	4		8	X	X	416SR /418SR/419SR/431SR/GHS-1500/SG-4002XC
GHP-2214D	4	8		2	X	X	
GHP-2020				20	X		
GHP-2020S				20	X		
GHP-2220	3	4		13	X	X	GH-430SR/432SR/520SR/620SR/820SR/GHI-611
GHP-2220G	2	12		6	X	X	/GHS-2000
GHP-2220Q	8	12			X	X	
GHP-3002	1		1			X	1U Chassis
GHP-3102	1	1				X	1U Chassis
GHP-3305	1	3	1			X	2U Chassis
GHP-3410	1	4	5			X	4U Chassis
GHP-3414	1	4	5		X	X	4U Chassis
GHP-3608	1	6	1			X	GHB-080
GHP-3712	1	7	4			X	4U Chassis
GHP-P14P12	2	12		1	X	X	4U Chassis
GHP-N2UP5	1	2	2			X	GHI-200/GH-288SR

Riser Card Series

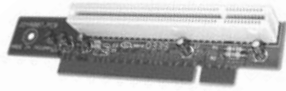

GHP-100

Independent 32 Bit PCI Slot only for GH-188 ATX model

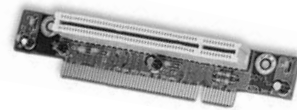

GHP-R0110(GHP-141)

Independent 32 Bit PCI Slot For 1U Rackmount Chassis

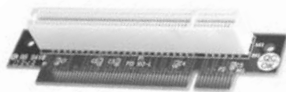

GHP-R0101

Independent 32Bit PCI Slot For 1U Rackmount Chassis



GHP-R0111

32Bit PCI Slot W/100mm Cable For 1U Rackmount Chassis

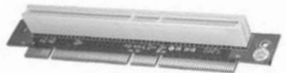

GHP-R0102

Independent 64Bit 5.0V PCI Slot For 1U Rackmount Chassis



GHP-R0119

Independent 64Bit 3.3V PCI Slot For 1U Rackmount Chassis

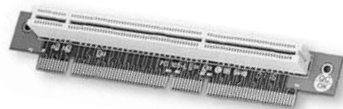

GHP-R0103

Independent 64Bit 3.3V PCI Slot For 1U Rackmount Chassis



GHP-R0309

Independent 64Bit 5.0V PCI Slot For 1U Rackmount Chassis

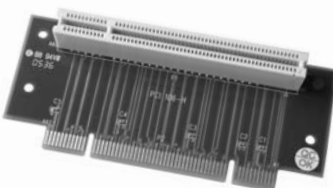

GHP-PCI106H

1 PCI 32Bit 5.0V For GHB-B05 or 1U Rackmount Chassis



GHP-08X16

1 PCI Express For 1U Rackmount Chassis

Riser Card Series



GHP-R0112

1 PCI 64Bit 3.3V W/70mm Cable For 1U Rackmount Chassis

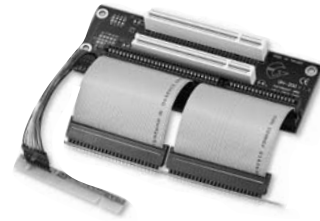

GHP-200

2 PCI or 1*PCI&1 ISA Expansion Slot For 2U Rackmount Chassis



GHP-R0113

1 PCIe X16 W/90mm Cable For 1U Rackmount Chassis



GHP-R0321

1 PCIe X16+2 PCI 32Bit W/85mm Cable For 2U Rackmount Chassis

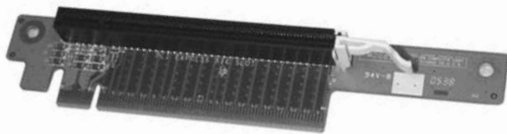

GHP-19X16

1 PCI Express X16 For 1U Rackmount Chassis

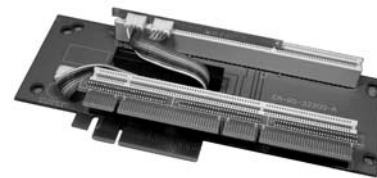

GHP-R0322

1 PCIe X8+2 PCI 64Bit 3.3V For 2U Rackmount Chassis

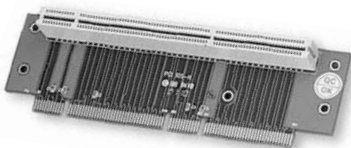

GHP-R0104

Independent 64Bit 3.3V PCI Slot For 2U Rackmount Chassis



GHP-R0323

1 PCIe X8+2 PCI 64Bit 3.3V W/90mm Cable For 2U Rackmount Chassis

Riser Card Series



GHP-R0324

1 PCIe X16+1 PCIe X16 W/65mm Cable +1 PCI 32Bit W/135mm Cable For 2U Rackmount Chassis

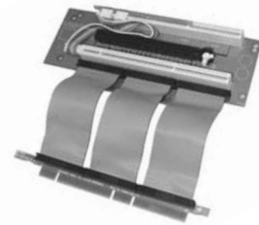

GHP-U746-C9

1 PCI Express X16+2 PCI-X64Bit 3.3V For 2U Rackmount Chassis

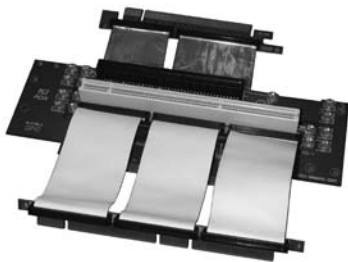

GHP-R0325

1 PCIe X16 + 1 PCIe X16 W/65mm Cable + 1 PCI-X W/90mm Cable For 2U Rackmount Chassis

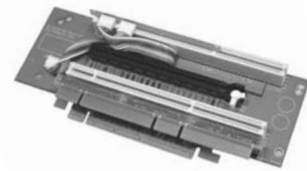

GHP-756

1 PCI Express X16+2 PCI-X64Bit 3.3V For 2U Rackmount Chassis



GHP-R0326

2 PCIe X4 W/60mm Cable For 2U Rackmount Chassis



GHP-780

1 PCI Express X16+2 PCI 32Bit W/30 Pin 100mm Cable

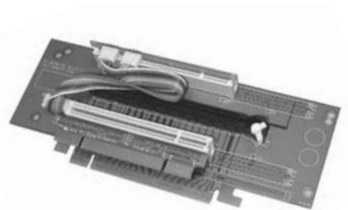

GHP-U740

1 PCI Express X16 + 2 PCI 32Bit For 2U Rackmount Chassis

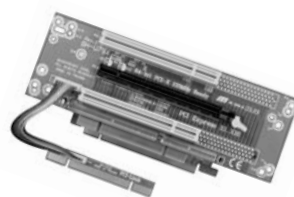

GHP-U790

2 PCI 5.0V 32Bit + 1 PCI Express X16 For 2U Rackmount Chassis

Riser Card Series



GHP-205

Independent 1-32Bit PCI Slot For 2U Rackmount Chassis



GHP-R0303

3-64Bit 3.3V PCI Slot For 2U Rackmount Chassis

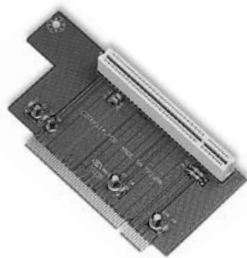

GHP-206

Independent 1-32Bit PCI Slot For 2U Rackmount Chassis



GHP-R0304

3-64Bit 3.3V PCI Slot For 2U Rackmount Chassis



GHP-R0301

3-32Bit PCI Slot For 2U Rackmount Chassis



GHP-R0308

3-32Bit PCI Slot For 2U Rackmount Chassis



GHP-R0302

3-64Bit 5.0V PCI Slot For 2U Rackmount Chassis

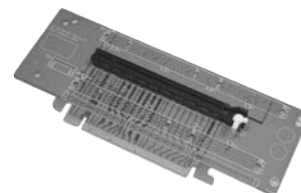

GHP-2UX16

1 PCI Express X16 For 2U Rackmount Chassis

Passive Backplane

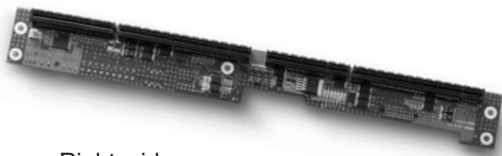

Right side

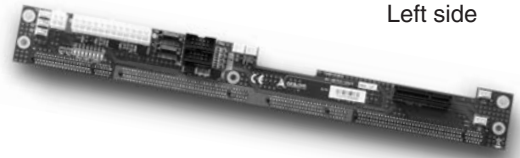

Left side

GHP-3002

1xPCIMG 1.3 & 1xPClex4

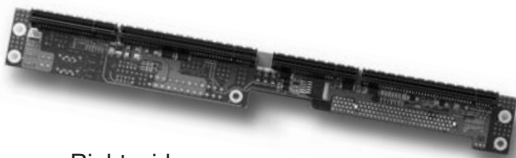

Right side

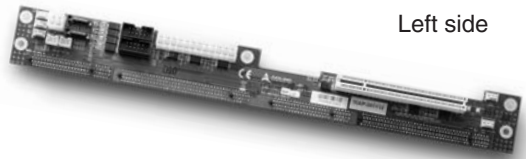

Left side

GHP-3102

1xPCIMG 1.3 & 1xPCI



Right side

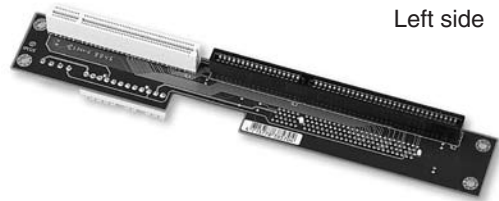

Left side

GHP-B2SD

1xPCI & 1xPICMG CPU Slot

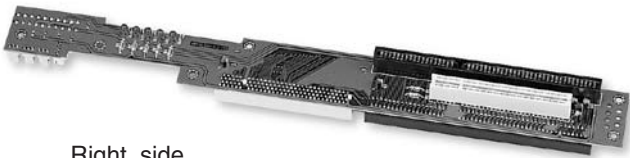

Right side



Left side

GHP-G1UG1

1xISA & 1xPCI & 1xPICMG CPU Slot

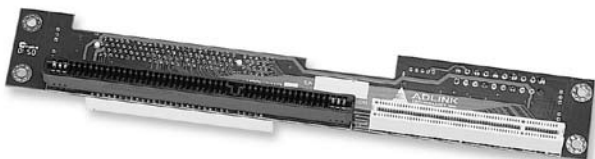

Right side

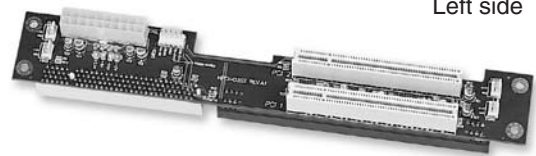

Left side

GHP-AD3S2

2xPCI & 1xPICMG CPU Slot

Passive Backplane

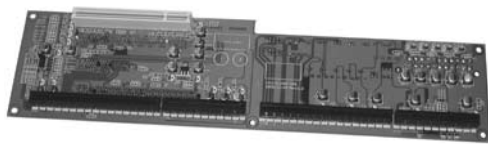

Right side

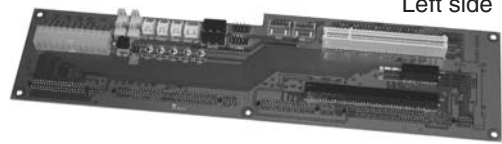

Left side

GHP-N2UP5

2xPCI & 2xPCI Express & 1xPICMG 1.3CPU Slot



Right side

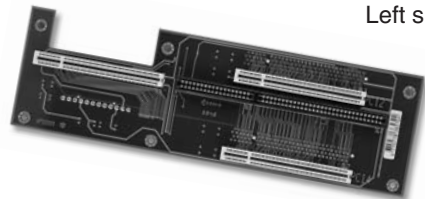

Left side

GHP-B4PS1

4xPCI & 1xPICMG CPU Slot

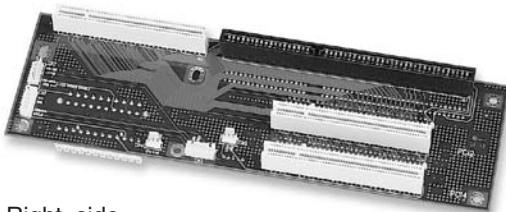

Right side

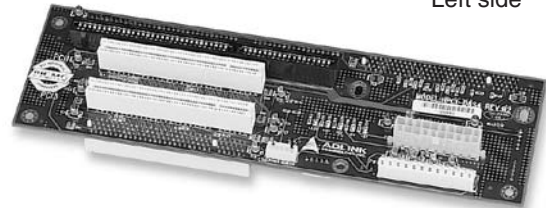

Left side

GHP-AD6S4

1xISA & 4xPCI & 1xPICMG CPU Slot



Right side

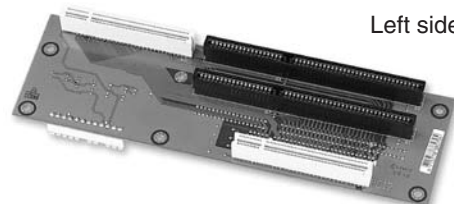

Left side

GHP-B6SD

3xISA & 2xPCI & 1xPICMG CPU Slot

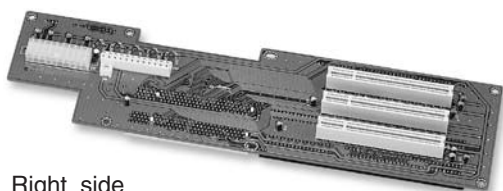

Right side

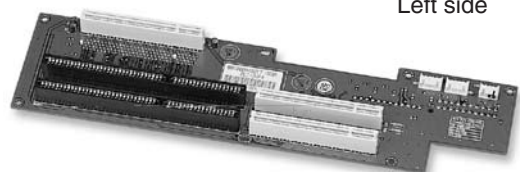

Left side

GHP-P2UP4

4xPCI & 2xPICMG CPU Slot

Passive Backplane

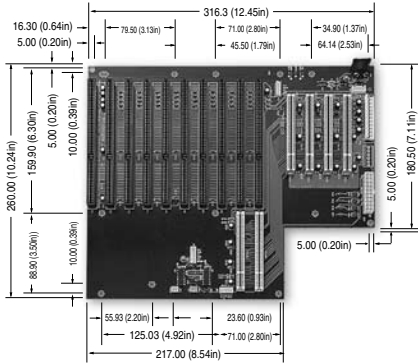

GHP-2214

8xISA & 4xPCI & 2xPICMG CPU Slot(Single System)

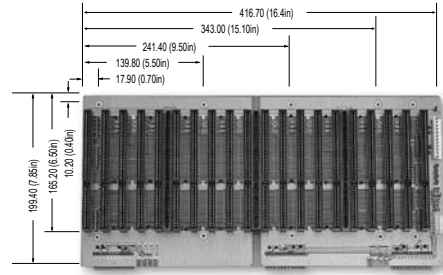

GHP-2020S

20xISA Slot(Quad System)

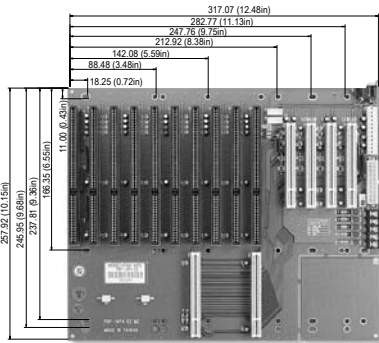

GHP-P14P4

8xISA & 4xPCI & 2xPICMG CPU Slot(Single System)

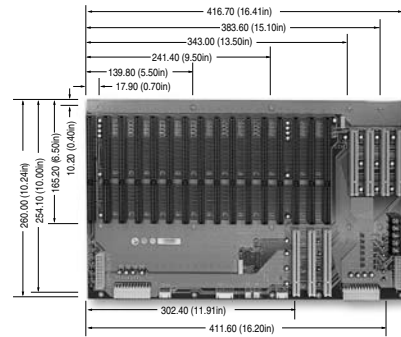

GHP-2220

13xISA & 4xPCI & 3xPICMG CPU Slot(Single System)

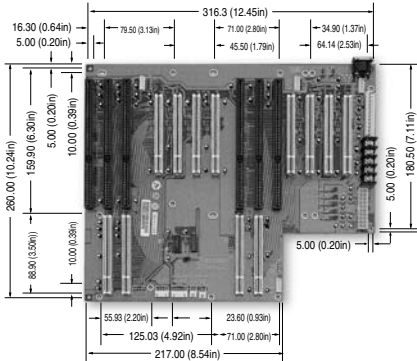

GHP-2214D

2xISA & 8xPCI & 4xPICMG CPU Slot(Dual System)

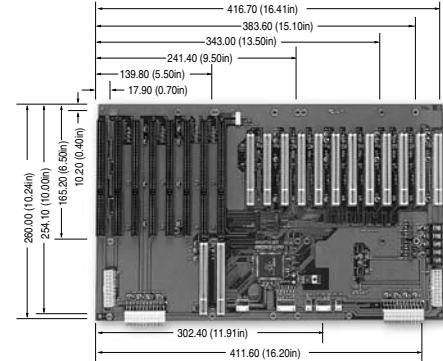

GHP-2220G

6xISA & 12xPCI & 2xPICMG CPU Slot(Single System)

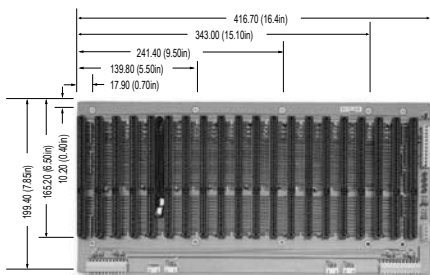

GHP-2020

20xISA Slot

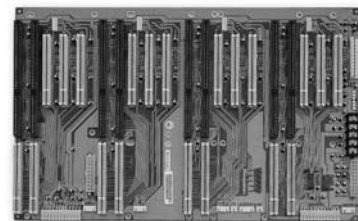

GHP-2220Q

12xPCI & 8xPICMG CPU Slot(Quad System)

19" Open Rack Series

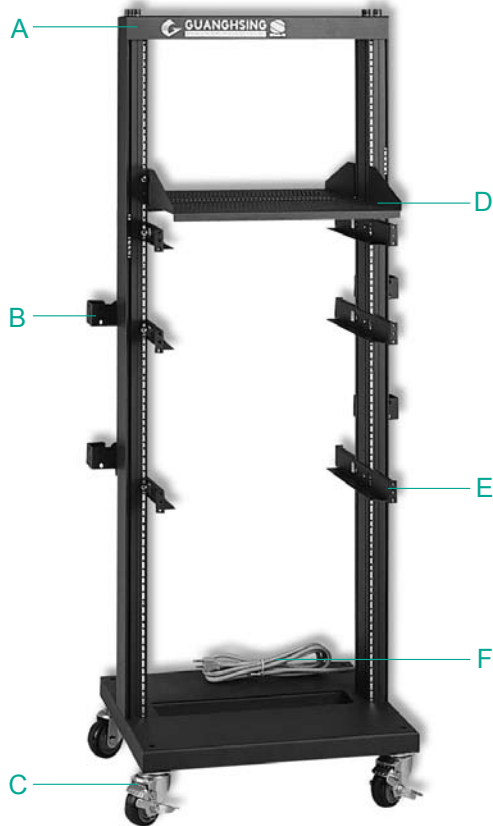

Specifications

- **Construction:** Aluminum Alloy
- **Color:** Beige or Black
- **Meet MIL-STD-167 & MIL-STD-810E Vibration Tests**
- **Applicable ANSI/EIA RS-310-C Standards**
- **Flexible & Easy Maintenance**
- **Standard Parts:** Main Frame(A) & 4xWheel(C) & 50xMounting Screws
- **Dimensions:**
 GHO-020: 540(W0)x1100(H0)x933(H1)x889(H2)x500(D0)mm
 21.3"(W0)x43.3"(H0)x36.7"(H1)x35.0"(H2)x19.7"(D0)
 GHO-035: 540(W0)x1767(H0)x1660(H1)x1556(H2)x500(D0)mm
 21.3"(W0)x69.6"(H0)x65.4"(H1)x61.3"(H2)x19.7"(D0)

Dimension

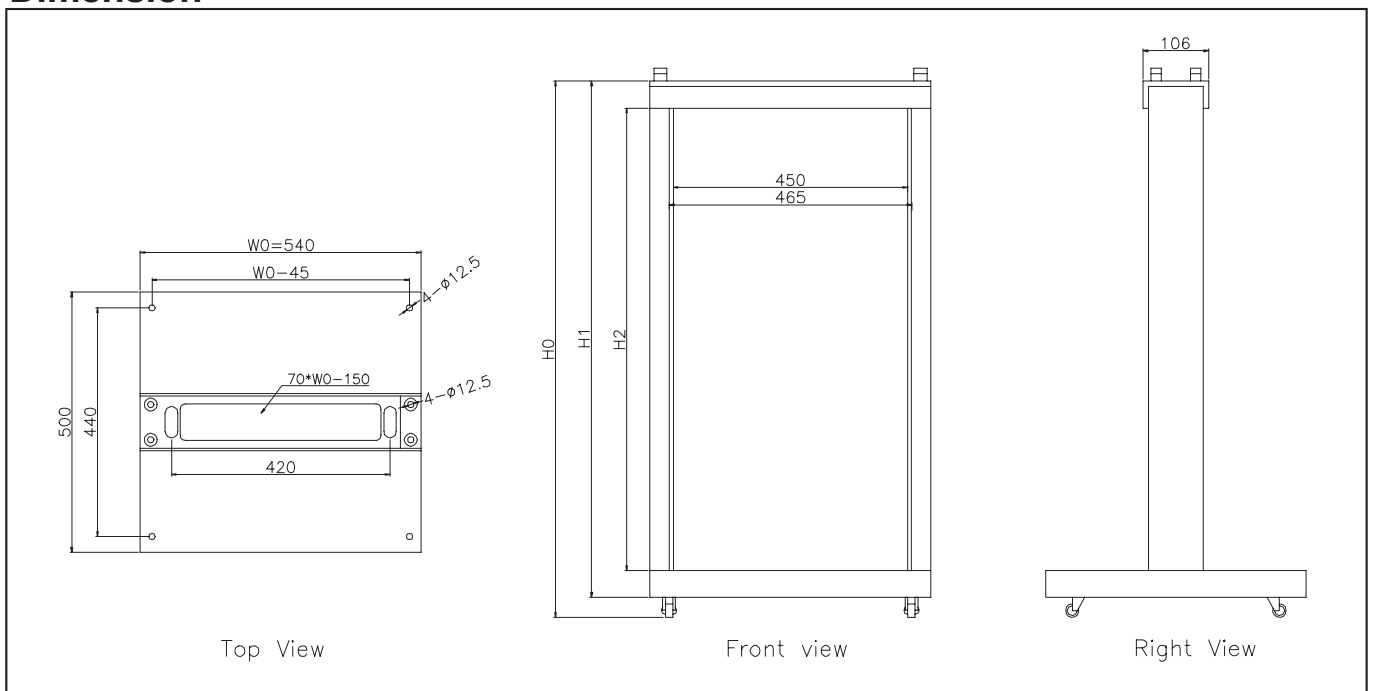

19" Open Rack Series

Optional Auxiliary Parts in Application

B



Cable Holder

- Used with Open Rack and to Keep any Cable line Tidy
- Model No.: GHO-H001
- Dimensions: 60(W)x80(H)x44(D)mm(2.4"x3.1"x1.7")

E



Mounting Support Bracket

- 1U High Bracket to mount Chassis
- Model No.: GHO-B400 (For Open Rack)
- Dimensions: 44(H)x500(D)mm(1.7"x19.7")

F



Mounting Support Bracket

- 1U High Bracket to mount Chassis
- Model No.: GHO-B500 (For 600mm Depth Cabinet)
- Dimensions: 44(H)x500(D)mm(1.7"x19.7")

D

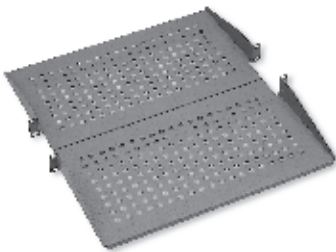

Full Size Support Tray

- To mount Open Rack, 2U High, suitable for non-standard and heavy weight application, can supporting for 60kg
- Model No.: GHO-T2200
- Dimensions: 483(W)x44(H)x500(D)mm(19"x1.7"x19.7")

D

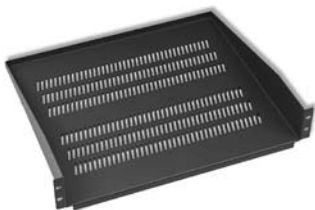

Half Size Support Tray

- To mount Open Rack, 2U High, suitable for non-standard and heavy weight application, can supporting for 25kg
- Model No.: GHO-T280
- Dimensions: 483(W)x88(H)x280(D)mm(19"x3.5"x11.0")
- Model No.: GHO-T400
- Dimensions: 483(W)x88(H)x400(D)mm(19"x3.5"x15.7")



Open Rack Application

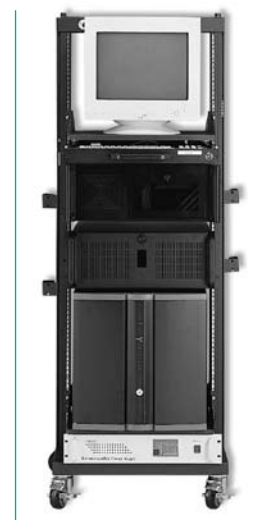

NOTE

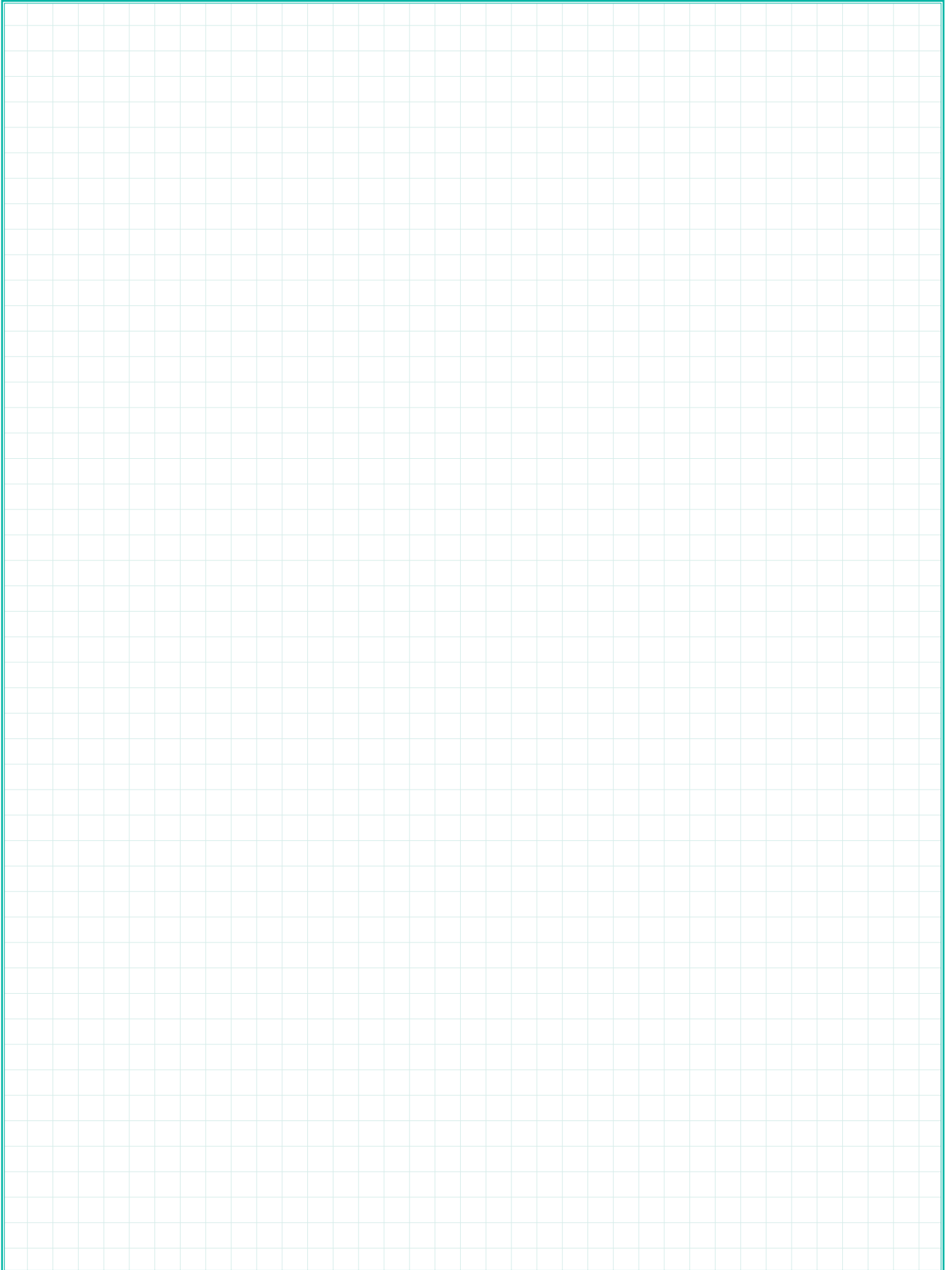

NOTE

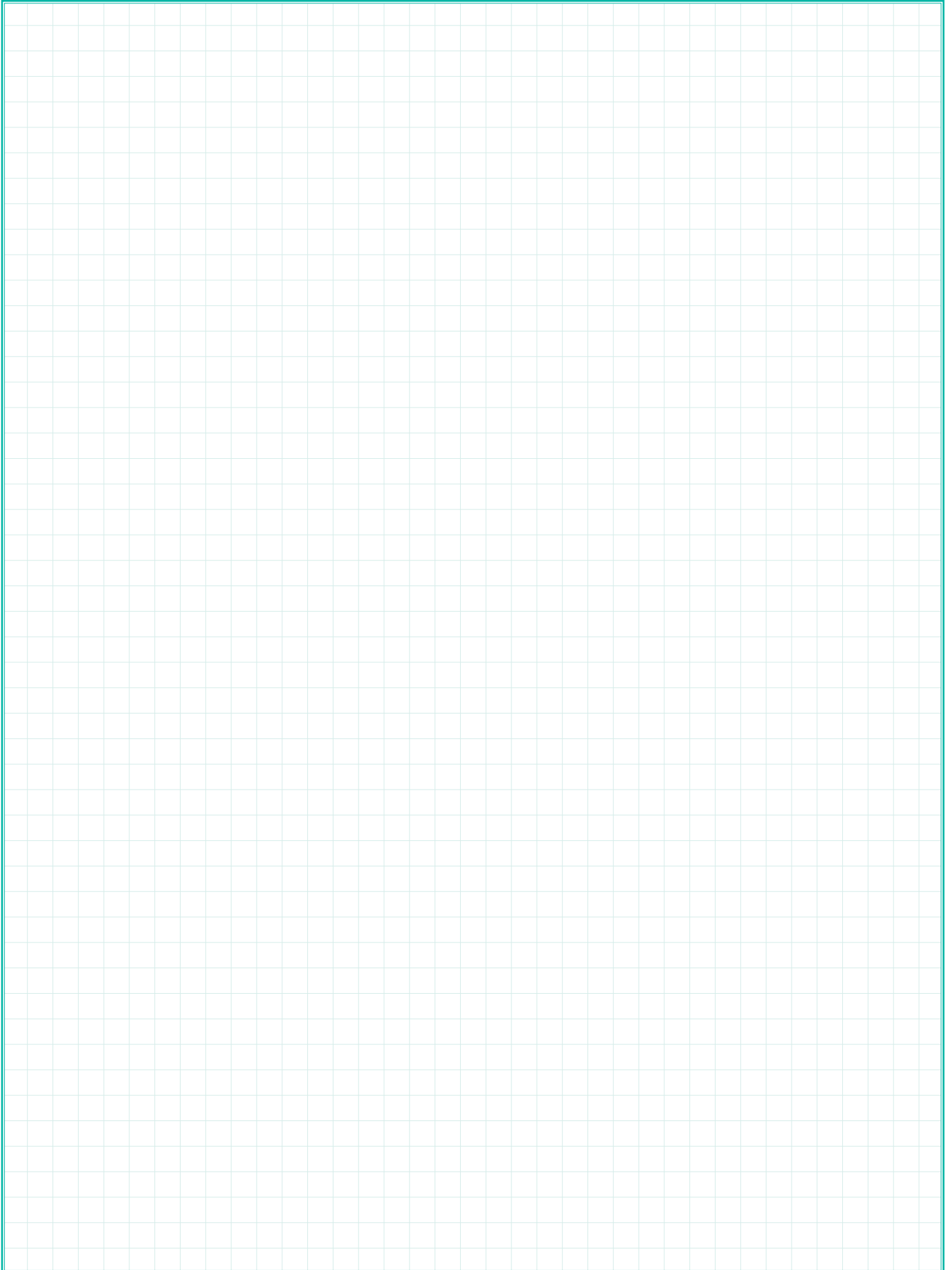

PREMIER Computer Handels GMBH

Woehlerstrasse 6

22113 Hamburg

Tel: +49 (0)40 7361610

Fax: +49 (0)40 73616133

www.premiercomputer.de

office@premiercomputer.de