

19" RACKMOUNT

Industrial Computer Chassis



n 142664

WWW.PREMIERCOMPUTER.DE

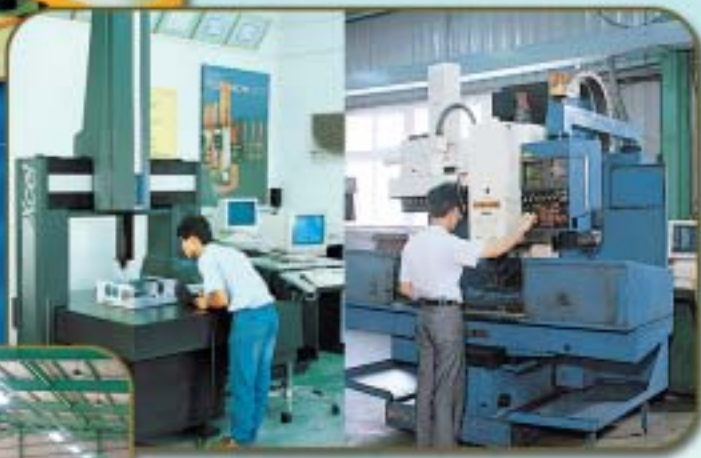

M

anagement Philosophy

Frugality

Sincerity

Innovation

Accountable

Company Profile

Established in 1972, Guanghsing located in the northern part of Taiwan, is one of the leaders in providing 19" Rackmount chassis, Storage, Wall Mount, and Compact PCI enclosures to Industrial Automation, Networking, ISP, Computer Telephony and Medical field. From custom designed rackmount chassis to our custom designed enclosures, Guanghsing products has been perennially recognized and well acknowledged by our customers as an Innovative, Top-Quality and Cost-Effective products.

By utilizing the advanced CAD/CAM design tools, Guanghsing's enclosures are one of the best cases available today. All of Guanghsing's in-house designed products are rugged, stable and made from premium quality steel. In order to ensure the quality and reduce total cost of ownership, Guanghsing documents every process and procedure to ensure that ISO is practiced and implemented through out the whole operation.

Guanghsing is dedicated to putting the same level of commitment and care to producing customized products as we are to customer service. We have an ongoing relationship with all our customers to discuss and review materials and production planning. From designing to final assembly, Guanghsing has the capability to meet all customization requirements.

In our 100,000+ square feet facility, manufacturing process is controlled by sophisticated equipment, well trained employees and each chassis is put through our strict Quality Management Team to ensure high standards and low failure rates. Our Sales Team are always dedicated to the prompt service and our engineers provide adaptive solutions for all customers' needs. We are here to achieve Total Customer Satisfaction!

Our facilities currently consist of these machineries:

Press Line:

Cross-Shaft Precision Press 25ton-250ton: 16 sets.
Shuttle Robot Line Precision Press 150ton: 6 sets.
Shuttle Robot Line Precision Press 200ton: 6 sets.

Spot Welding Line:

Spot Welding Machine: 16 sets.
Cap Spot Welding Machine: 2 sets.
Multi-Spindle Spot Welding Machine: 2 sets.
Multi-Spindle Rivet Fastening Machine: 6 sets.

Assembly Line:

Assembly Line 30M: 3 lines.

Guanghsing is perpetually researching and developing innovative and cost effective methods to provide quality products at reasonable pricing. We are striving forward in order to provide YOU with the latest technology. Our goal is to deliver:

Quality Assured, Cost Effective Chassis Solutions





RACKMOUNT CHASSIS SERIES

GHI-100/101	1U Rackmount Chassis	11
GHI-104/104DX	1U Rackmount Chassis	12
GHI-105/105DX	1U Rackmount Chassis	13
GHI-106	1U Rackmount Chassis	14
GHI-107	1U Rackmount Chassis	15
GHI-110	1U Rackmount Chassis	16
GHI-112	1U Rackmount Chassis	17
GHI-113	1U Rackmount Chassis	18
GHI-114	1U Rackmount Chassis	19
GHI-130	1U Rackmount Chassis	20
GHI-142	1U Rackmount Chassis	21
GHI-160	1U Rackmount Chassis	22
GHI-180	1U Rackmount Chassis	23
GHI-181/181WV2	1U Rackmount Chassis	24
GH-188ATX	1U Rackmount Chassis	25
GHI-189	1U Rackmount Chassis	26
new GHI-192	1U Rackmount Chassis	27
GH-198B/198L	1U Rackmount Chassis	28
GHI-200	2U Rackmount Chassis	29
GHI-210	2U Rackmount Chassis	30
GH-212ATX	2U Rackmount Chassis	31
GHI-213	2U Rackmount Chassis	32
new GHI-214	2U Rackmount Chassis	33
new GHI-220	2U Rackmount Chassis	34
new GHI-221	2U Rackmount Chassis	35
GHI-230	2U Rackmount Chassis	36
GH-231ATX	2U Rackmount Chassis	37
GH-232ATX	2U Rackmount Chassis	38
new GHI-240	2U Rackmount Chassis	39
new GHI-246	2U Rackmount Chassis	40
GHI-250	2U Rackmount Chassis	41
GHI-251	2U Rackmount Chassis	42
GHI-252V/252H	2U Rackmount Chassis	43
new GHI-260	2U Rackmount Chassis	44
GHI-280/280V/280WV2	2U Rackmount Chassis	45
GHI-281/281V/281WV2	2U Rackmount Chassis	46
GHI-282/282V	2U Rackmount Chassis	47
GHI-283/283V/283WV2	2U Rackmount Chassis	48
GH-288SR	2U Rackmount Chassis	49
GHI-289	2U Rackmount Chassis	50
GHI-290	2U Rackmount Chassis	51
new GHI-293	2U Rackmount Chassis	52
GH-310ATXR	3U Rackmount Chassis	53
GHI-312	3U Rackmount Chassis	54
GHI-313	3U Rackmount Chassis	55
new GHI-314	3U Rackmount Chassis	56
new GHI-315	3U Rackmount Chassis	57
GH-341ATX	3U Rackmount Chassis	58
GHI-342	3U Rackmount Chassis	59
GHI-350	3U Rackmount Chassis	60
new GHI-360	3U Rackmount Chassis	61
GHI-380	3U Rackmount Chassis	62
GHI-381	3U Rackmount Chassis	63
GHI-390	3U Rackmount Chassis	64
GH-400ATX/400S	4U Rackmount Chassis	65
GH-402ATXR/402SR	4U Rackmount Chassis	66
GHI-403ATXR/403SR	4U Rackmount Chassis	67
GH-410ATXR/410SR	4U Rackmount Chassis	68
GH-411ATXR/411SR	4U Rackmount Chassis	69
GH-414ATXR/414SR	4U Rackmount Chassis	70
new GHI-415	4U Rackmount Chassis	71
GH-416ATXR/416SR	4U Rackmount Chassis	72
GH-418ATXR/418SR	4U Rackmount Chassis	73
GHI-419ATXR/419SR	4U Rackmount Chassis	74
GH-430ATXR/430SR	4U Rackmount Chassis	75
GH-431ATXR/431SR	4U Rackmount Chassis	76
GH-432ATXR/432SR	4U Rackmount Chassis	77
GHI-440	4U Rackmount Chassis	78
GHI-441	4U Rackmount Chassis	79
GHI-442	4U Rackmount Chassis	80
new GHI-450	4U Rackmount Chassis	81
GHI-480	4U Rackmount Chassis	82
GHI-481	4U Rackmount Chassis	83
GH-520SR/530ATXR	5U Rackmount Chassis	84
GHI-580	5U Rackmount Chassis	85
GHI-581	5U Rackmount Chassis	86
GHI-583	5U Rackmount Chassis	87
new GHI-584	5U Rackmount Chassis	88
GH-600ATXR/620SR	6U Rackmount Chassis	89
GHI-611	6U Rackmount Chassis	90
GHI-690	6U Rackmount Chassis	91
GHI-691	6U Rackmount Chassis	92
GH-800ATXR/820SR	8U Rackmount Chassis	93
GHI-P01	8U Rackmount Chassis	94
GHB-B04	6U-1/4 Rackmount Chassis	95
new GHB-B05	Multi-FunTION Chassis	96
GHB-B08	6U-1/2 Rackmount Chassis	97
GHB-042	6U-1/4 Rackmount Chassis	98

Index

new GHB-043	6U-1/4 Rackmount Chassis.....	99
GHB-060	6-Slot Micro Box Chassis.....	100
GHB-061	6-Slot Micro Box Chassis.....	101
GHB-062-6	6-Slot Micro Box Chassis.....	102
GHB-062-8	8-Slot Micro Box Chassis.....	103
GHB-080	8-Slot Micro Box Chassis.....	104
GHB-082-8	8-Slot Micro Box Chassis.....	105
GHB-082-10	10-Slot Micro Box Chassis.....	106
GHB-083-8	8-Slot Micro Box Chassis.....	107
GHB-083-10	10-Slot Micro Box Chassis.....	108
GHB-120ATXR/120SR	Micro Box Chassis.....	109
GH-M15/M17	Monitor Enclosure.....	110
GHK-M01	1U 15" LCD Monitor.....	111
GHK-M02	1U 15" LCD Monitor with 8 Ports KVM.....	112
GH-K02	1U Rackmount Keyboard Drawer.....	113
GH-KD1	1U Rackmount Keyboard Drawer.....	113
GH-KD4	1U Rackmount Keyboard Drawer.....	113

COMPACT PCI SERIES

GHC-C01	1U Compact PCI.....	114
GHC-C02	2U Compact PCI.....	115
GHC-C03	3U Compact PCI.....	116
GHC-C04	4U Compact PCI.....	117
GHC-P03	8U Compact PCI.....	118
OEM	119

STORAGE & SERVER SERIES

GHR-219	2U Rackmount Storage Chassis.....	120
new GHR-390	3U Rackmount Storage Chassis.....	121
GHR-420	4U Rackmount Storage Chassis.....	122
GHR-421	4U Rackmount Storage Chassis.....	123
GHR-422	4U Rackmount Storage Chassis.....	124
GHR-2104	Disk Array Chassis.....	125
GHS-1500	Server Case.....	126
GHS-2000	Server Case.....	127
SG-1200	Server Case.....	128
SG-4002XC	Server Case.....	129
new GHK-425	Hot-Swappable Disk Array.....	130
GHK-431/541	Hot-Swappable Disk Array.....	131

ACCESSORIES

GHA-CO01	Thermal Management Card.....	132
GHA-CO02	Thermal Management Card.....	
GHA-CO03	Thermal Management Card.....	
GHA-CO04	Thermal Management Card.....	
GHA-CO05	Thermal Management Card.....	
GHA-BRM1	IPC Accessory.....	
GHA-SL20/SL26	Slide Rail.....	133
GHA-SL20-1U/SL24-1U	Slide Rail.....	
RL-CC1001-99-0104/	Slide Rail.....	
CC3001-00-0240/	Slide Rail.....	
CC3001-00-0260	Slide Rail.....	
GHA-H199	3.5" HDD Bracket.....	
GHA-H211	3.5" HDD Bracket.....	
GHA-H300	3.5" HDD Bracket.....	134
GHA-H414	3.5" HDD Bracket.....	
GHA-H431	3.5" HDD Bracket.....	
GHA-H432	3.5" HDD Bracket.....	
GHA-H280	3.5" HDD Bracket.....	
GHA-H380	3.5" HDD Bracket.....	
GHA-H480	3.5" HDD Bracket.....	135
GHA-1520	Rackmount Accessory.....	
GHA-4HL	IPC Accessory.....	
GHA-4UH	IPC Accessory.....	
GHA-4UL	IPC Accessory.....	
GHA-TE01	Hold Down Bar.....	
GHA-YT01	Hold Down Bar.....	136
GHA-410	Hold Down Bar.....	
GHA-418	Hold Down Bar.....	
GHA-F123	Cooling Fan.....	
GHA-F418	Cooling Fan.....	
GHA-F520	Cooling Fan.....	
GHA-FM01	Drive Adapter.....	137
GHA-FM03/FH03	Drive Adapter.....	
GHA-FM04/FH04	Drive Adapter.....	
GHA-FM05/FH05	Drive Adapter.....	
GHA-FM06	Drive Adapter.....	
GHA-FM07	Drive Adapter.....	
GHA-FM801	Drive Adapter.....	138
GHA-ED01X	Thermal Management Box.....	
SDR-083	Slim DVD-R.....	
SDW-0825	Slim DVD-RW.....	
GHA-SR242	Slim CD-ROM.....	
GHA-D353	Slim FDD.....	

GHA-K002	Coupling Adapter.....	139
GHA-K003	Adapter.....	
GHA-K004	Adapter.....	
GHA-K005	USB & PS2 Adapter.....	
GHA-K006	USB Adapter.....	
GHA-181WV2	1U WV2 Kit.....	
GHA-280WV2	2U WV2 Kit.....	
GHA-DVR-17H	DVR Rear Window.....	140
GHA-BW205	2-slots Rear Window.....	
GHA-BW206	2-slots Rear Window.....	
GHA-BW256	2-slots Rear Window.....	
GHA-BW305	3-slots Rear Window.....	
GHA-BW306	3-slots Rear Window.....	
new GHA-690A/B/C/D	GHI-690/691 Extra Device.....	141

PASSIVE BACKPLANE & RISER CARD

GHP-100	1-slot Riser Card.....	144
GHP-R0101	1-slot Riser Card.....	
GHP-R0102	1-slot Riser Card.....	
GHP-R0103	1-slot Riser Card.....	
GHP-R0104	1-slot Riser Card.....	
GHP-R0110(GHP-141)	1-slot Riser Card.....	
GHP-R0119	1-slot Riser Card.....	
GHP-200	2-slots Riser Card.....	
new GHP-PCI106H	1-slot Riser Card.....	145
new GHP-08X16	1-slot Riser Card.....	
new GHP-19X16	1-slot Riser Card.....	
new GHP-U642-C7	2-slots Riser Card.....	
new GHP-U656-C5	2-slots Riser Card.....	
new GHP-U740	2-slots Riser Card.....	
new GHP-U746-C9	2-slots Riser Card.....	
new GHP-U790	2-slots Riser Card.....	
GHP-205	2-slots Riser Card.....	146
GHP-206	2-slots Riser Card.....	
GHP-R0301	3-slots Riser Card.....	
GHP-R0302	3-slots Riser Card.....	
GHP-R0303	3-slots Riser Card.....	
GHP-R0304	3-slots Riser Card.....	
GHP-R0305	3-slots Riser Card.....	
GHP-R0309	3-slots Riser Card.....	
GHP-R0308	3-slots Riser Card.....	147
GHP-AGP01	3-slots Riser Card.....	
GHP-AGP02	3-slots Riser Card.....	
GHP-AGP03	3-slots Riser Card.....	
GHP-AGP04	3-slots Riser Card.....	
GHP-AGP05	3-slots Riser Card.....	
GHP-AGP06	3-slots Riser Card.....	
GHP-AGP07	3-slots Riser Card.....	
GHP-B2SD	2-slots Backplane.....	148
GHP-G1UG1	2-slots Backplane.....	
GHP-AD3S2	3-slots Backplane.....	
new GHP-N2UP5	5-slots Backplane.....	
GHP-B4PS1	5-slots Backplane.....	149
GHP-AD6S4	5-slots Backplane.....	
GHP-B6SD	6-slots Backplane.....	
GHP-P2UP4	6-slots Backplane.....	
GHP-2004	4-slots Backplane.....	150
GHP-2204	4-slots Backplane.....	
GHP-2006	6-slots Backplane.....	
GHP-2206	6-slots Backplane.....	
GHP-2308	8-slots Backplane.....	
GHP-2008	8-slots Backplane.....	
GHP-2208	8-slots Backplane.....	
GHP-2014	14-slots Backplane.....	
GHP-2214	14-slots Backplane.....	151
GHP-P14P4	14-slots Backplane.....	
GHP-2214D	14-slots Backplane.....	
GHP-2020	20-slots Backplane.....	
GHP-2020S	20-slots Backplane.....	
GHP-2220	20-slots Backplane.....	
GHP-2220G	20-slots Backplane.....	
GHP-2220Q	20-slots Backplane.....	
GHP-PCI110-ATX	10-slots Backplane.....	152
GHP-206B-AT	6-slots Backplane.....	
GHP-PCI6R-ATX	6-slots Backplane.....	
GHP-PCI-08P4	8-slots Backplane.....	
GHP-101-ATX	10-slots Backplane.....	
GHP-10P7-E1	10-slots Backplane.....	
GHP-PCI4-ATX	4-slots Backplane.....	
GHP-06P3	6-slots Backplane.....	

19" OPEN RACK SERIES

19" Open Rack Series.....	153
19" Open Rack Series.....	154

Chassis Comparison Chart

Model	Mounting Configuration options		Board Options		Bus Architecture			Max. Number of Slots	Power Supply Options		Fan space#				
	Rack	Tower Wall/ Panel	Passive B/P	ATX/AT M/B	CPU	ISA	PCI		cPCI H. 100	Watts	P/S Type	4 cm	6 cm	8 cm	9 cm
GHI-100	x		x		x	x	x		3	250-350	1U				3
GHI-101	x		x		x	x	x		3	250-350	1U				3
GHI-104	x			12"x13"					1	250-500	1U				3+2/6
GHI-105	x			12"x9.6"					1	250-500	1U				4
GHI-106	x			6.7"x6.7"					1	150-200	1U				
GHI-107	x			12"x9.6"					1	250-400	1U				2
GHI-110	x			12"x9.6"					1	250-350	1U				2+3
GHI-112	x			12"x9.6"					1	250-350	1U				3
GHI-113	x			12"x13"					1	250-500	1U				7
GHI-114	x			12"x13"					1	500	1U				6
GHI-130	x			12"x13"					1	250-300	1U				6+3
GH-142	x			12"x13"					1	250-400	1U				5+5
GHI-160	x			12"x13"					1	250-500	1U				6
GHI-180	x			12"x13"					1	250-400	1U				6
GHI-181	x			12"x13"					1	250-500	1U				6
GHI-181WV2	x			12"x13"					2	250-500	1U				6
GH-188ATX	x			12"x9.6"					1	180-300	1U				2
GHI-189	x		x		x		x			250-500	1U				6
GHI-192	x			12"x10.6"					1	250-500	1U				6
GH-198B	x		x		x		x		2	180-300	1U				3
GH-198L	x			Little board						180-300	1U				3
GHI-200	x		x		x	x	x		6	250-400	PS/2 or Mini Redundant				3
GHI-210	x			12"x9.6"					3	250-400	PS/2 or Mini Redundant				3
GH-212ATX	x			12"x9.6"					3	250-460	PS/2(F)		1	1	
GHI-213	x			12"x9.6"					3	250-400	PS/2 or Mini Redundant				3
GHI-214	x			12"x13"					3	600	2U Single or Redundant				3
GHI-220	x			12"x10.5"					3	400	2U Redundant		1	4	
GHI-221	x			12"x13"					3	600	2U Single or Redundant		1	4	
GHI-230	x			12"x13"					3	250-400	PS/2 or Mini Redundant		1	1	
GH-231ATX	x			12"x13"					3	250-400	2U				3
GH-231	x			12"x13"					7	250-400	2U				3
GH-232ATX	x			12"x13"					3	250-460	PS/2 Special		1	3	
GH-232	x			12"x13"					7	250-460	PS/2 Special		1	3	
GHI-240	x			16"x13"					3	600	2U Redundant		2	4	
GHI-246	x			12"x13"					3	600	2U Single or Redundant				4
GHI-250	x			12"x9.6"					5	250-300	1U				2
GHI-251	x			12"x9.6"					7	250-300	1U				2
GHI-252V	x			12"x9.6"					7	250-300	1U		2	1	
GHI-252H	x			12"x9.6"					3	250-300	1U		2	1	
GHI-260	x			12"x13"					3	600	2U Single or Redundant				4
GHI-280	x			12"x13"					3	600	2U Single or Redundant				4
GHI-280V	x			12"x13"					7	600	2U Single or Redundant				4
GHI-280WV2	x			12"x13"					6	600	2U Single or Redundant				4
GHI-281	x			12"x13"					3	600	2U Single or Redundant				4
GHI-281V	x			12"x13"					7	600	2U Single or Redundant				4
GHI-281WV2	x			12"x13"					6	600	2U Single or Redundant				4
GHI-282	x			12"x9.6"					3	510	2U Single or Redundant				4
GHI-282V	x			12"x9.6"					7	510	2U Single or Redundant				4

Chassis Comparison Chart

Air Flow	Disk Mounting VD =Vibration Damping					Keyboard Connector		Dimensions (millimeters/inch)			Front Panel Indicator					Front Panel Controls						
	CFM/EACH	2.5" Int	3.5" Int	5.25" Int	3.5" F.P.	5.25" F.P.	Front	Rear	Width	Height	Depth	On/Off	HD Active	Over Heat	Fan Fail	P.S. Status	LAN Active	On/Off	LAN	USB	Reset	Keylock
7.0	☆1	2		△1	△1	x	x	483/19"	44/1.7"	450/17.7"	x	x						x	x	x		
7.0	☆1	2		△1	△1	x	x	483/19"	44/1.7"	450/17.7"	x	x						x	x	x		
10.8/15.3		2		1	1		x	483/19"	44/1.7"	605/23.8"	x	x						x	x	x		
15.3		2		1	1		x	483/19"	44/1.7"	542/21.3"	x	x						x	x	x		
N/A	1			1	1		x	483/19"	44/1.7"	220/8.7"	x	x						x	x	x		
15.3		2				x		483/19"	44/1.7"	382/15.0"	x	x						x			x	
7.0/8.6		3		△1	△1	x	x	483/19"	44/1.7"	450/17.7"	x	x						x	x	x		
15.3		1		△1	△1		x	483/19"	44/1.7"	407/16.0"	x	x						x	x	x		
15.3		2			1		x	483/19"	44/1.7"	650/25.6"	x	x						x	x	x		
15.3		1		1	1		x	483/19"	44/1.7"	543/21.4"	x	x				x		x	x	x		
7.0/8.6		3		△1	△1		x	483/19"	44/1.7"	650/25.6"	x	x	x	x		x		x			x	
7.0/8.6		2		△1	△1		x	483/19"	44/1.7"	650/25.6"	x	x	x	x		x		x			x	
15.3	9							483/19"	44/1.7"	650/25.6"	x	x	x	x				x			x	
15.3		4		1	1		x	483/19"	44/1.7"	650/25.6"	x	x	x	x		x		x	x	x		
15.3				2	1		x	483/19"	44/1.7"	650/25.6"	x	x	x	x		x		x	x	x		
15.3				2	1		x	483/19"	44/1.7"	650/25.6"	x	x	x	x		x		x	x	x		
7.0	1			1	2		x	483/19"	44/1.7"	520/20.5"	x	x						x			x	
15.3		2			△1			483/19"	44/1.7"	700/27.5"	x	x				x		x	x	x		
7.0		2			1		x	483/19"	44/1.7"	560/22.1"	x	x						x		x	x	
7.0	1	1		1	1	x	x	483/19"	44/1.7"	431/17"	x	x						x			x	
7.0	1	1		1	1	x	x	483/19"	44/1.7"	431/17"	x	x						x			x	
42.5		1+☆1		1	△1	x	x	483/19"	88/3.5"	450/17.7"	x	x						x	x	x		
42.5		4		1	△1		x	483/19"	88/3.5"	450/17.7"	x	x						x	x	x		
23.5/42.5		3		1	1		x	483/19"	88/3.5"	501/19.7"	x	x						x			x	x
42.5		3		1	1		x	483/19"	88/3.5"	450/17.7"	x	x						x			x	
42.5		3		1	1+△1		x	483/19"	88/3.5"	510/20.1"	x	x						x	x	x		
23.5/42.5		2		1	4		x	483/19"	88/3.5"	570/22.4"	x	x			x		x	x	x	x		
23.5/42.5		2		1	4		x	483/19"	88/3.5"	650/25.6"	x	x			x		x	x	x			
23.5/42.5		6		1	1		x	483/19"	88/3.5"	650/25.6"	x	x	x	x				x			x	
42.5		3		2	2		x	483/19"	88/3.5"	650/25.6"	x	x						x			x	x
42.5		3		2	2		x	483/19"	88/3.5"	650/25.6"	x	x						x			x	x
23.5/42.5		5		1	1		x	483/19"	88/3.5"	650/25.6"	x	x						x			x	x
23.5/42.5		5		1	1		x	483/19"	88/3.5"	650/25.6"	x	x						x			x	x
15.3/42.5		4			△1		x	483/19"	88/3.5"	710/28.0"	x	x			x		x	x	x	x		
42.5		5			1		x	483/19"	88/3.5"	650/25.6"	x	x						x	x	x		
42.5		1		△1	1		x	483/19"	88/3.5"	355/13.9"	x	x				x		x			x	
42.5		2			1		x	483/19"	88/3.5"	355/13.9"	x	x				x		x	x	x		
42.5/7.0		3			1		x	483/19"	88/3.5"	355/13.9"	x	x				x		x	x	x		
42.5/7.0		3			1		x	483/19"	88/3.5"	355/13.9"	x	x				x		x	x	x		
42.5	16				1		x	483/19"	88/3.5"	650/25.6"	x	x	x	x				x	x	x		
42.5		8		△1	△1		x	483/19"	88/3.5"	650/25.6"	x	x	x	x		x		x	x	x		
42.5		8		△1	△1		x	483/19"	88/3.5"	650/25.6"	x	x	x	x		x		x	x	x		
42.5		8		△1	△1		x	483/19"	88/3.5"	650/25.6"	x	x	x	x		x		x	x	x		
42.5		6		△1	1		x	483/19"	88/3.5"	650/25.6"	x	x	x	x		x		x	x	x		
42.5		6		△1	1		x	483/19"	88/3.5"	650/25.6"	x	x	x	x		x		x	x	x		
42.5		6		△1	1		x	483/19"	88/3.5"	650/25.6"	x	x	x	x		x		x	x	x		
42.5		8		△1	△1		x	483/19"	88/3.5"	650/25.6"	x	x	x	x		x		x	x	x		
42.5		8		△1	△1		x	483/19"	88/3.5"	650/25.6"	x	x	x	x		x		x	x	x		

(F)=Front (H)=Horizontal (V)=Vertical ☆=Optional kit for 3.5" internal Disk Mounting ★= Optional Fan △=For Slim Type Disk

Chassis Comparison Chart

Model	Mounting Configuration options		Board Options		Bus Architecture			Max. Number of Slots	Power Supply Options		Fan space#					
	Rack	Tower Wall/ Panel	Passive B/P	ATX/AT M/B	CPU	ISA	PCI		cPCI H. 100	Watts	P/S Type	4 cm	6 cm	8 cm	9 cm	12 cm
GHI-283	x			12"x13"					3	600	2U Single or Redundant				4	
GHI-283V	x			12"x13"					7	600	2U Single or Redundant				4	
GHI-283WV2	x			12"x13"					6	600	2U Single or Redundant				4	
GH-288SR	x		x			x	x	x	6	250-500	PS/2 or Mini Redundant				2	
GHI-289	x		x			x	x	x	6	300-600	2U Single or Redundant	1			4	
GHI-290	x			12"x13"					3	500	2U Single or Redundant				4	
GHI-293	x			12"x10.5"					3	550	2U Single or Redundant				3	
GH-310ATXR	x			12"x9.6"					7	230-700	PS/2 or Mini Redundant(F)			1	2	
GHI-312	x			12"x13"					7	460-700	2U Single or Redundant	2			5	
GHI-313	x			12"x10.5"					7	460-600	2U Single or Redundant		1		2	
GHI-314	x			12"x10.5"					7	460-700	2U Single or Redundant	4	2			1
GHI-315	x			12"x9.6"					7	460-700	2U Single or Redundant	2	2	1		
GH-341ATX	x			12"x13"					7	250-700	2U Single or Redundant	2			3	
GHI-342	x			12"x13"					7	460-700	2U Single or Redundant		1		3	
GHI-350	x			12"x9.6"					7	300-460	2U Single	2	★1	2		
GHI-360	x			12"x13"					7	460-650	2U/3U Single or Redundant		1		4	
GHI-380	x			12"x13"					7	460-650	2U/3U Single or Redundant		1		4	
GHI-381	x			12"x13"					7	460-650	2U/3U Single or Redundant		1		4	
GHI-390	x			12"x13"					7	460-650	2U/3U Single or Redundant		1		4	
GH-400ATX	x			12"x9.6"					7	230-700	PS/2			2		
GH-400S	x		x			x	x	x	14	230-700	PS/2			2		
GH-402ATXR	x			12"x9.6"					7	230-700	PS/2 or Mini Redundant				2	
GH-402SR	x		x			x	x	x	14/15	230-700	PS/2 or Mini Redundant				2	
GHI-403ATXR	x			12"x9.6"					7	230-700	PS/2 or Mini Redundant				2	
GHI-403SR	x		x			x	x	x	14/15	230-700	PS/2 or Mini Redundant				2	
GH-410ATXR	x			12"x9.6"					7	230-700	PS/2 or Mini Redundant					1+★1
GH-410SR	x		x			x	x	x	14/15	230-700	PS/2 or Mini Redundant					1+★1
GH-411ATXR	x			12"x9.6"					7	230-700	PS/2 or Mini Redundant					1+★1
GH-411SR	x		x			x	x	x	14/15	230-700	PS/2 or Mini Redundant					1+★1
GH-414ATXR	x			12"x9.6"					7	230-700	PS/2 or Mini Redundant					1+★1
GH-414SR	x		x			x	x	x	14/15	230-700	PS/2 or Mini Redundant					1+★1
GHI-415	x			12"x13"					14	230-700	PS/2 or Mini Redundant	2			3	
GH-416ATXR	x			12"x9.6"					7	230-700	PS/2 or Mini Redundant					1+★1
GH-416SR	x		x			x	x	x	14/15	230-700	PS/2 or Mini Redundant					1+★1
GH-418ATXR	x			12"x9.6"					7	230-700	PS/2 or Mini Redundant				★3	1
GH-418SR	x		x			x	x	x	14	230-700	PS/2 or Mini Redundant				★3	1
GHI-419ATX	x			12"x13"					7	230-700	PS/2 or Mini Redundant	★2			2	
GHI-419SR	x		x						14/15	230-700	PS/2 or Mini Redundant	★2			2	
GH-430ATXR	x			12"x13"					7	300-460	Vertical Redundant(F)			★1	4	
GH-430SR	x		x			x	x	x	19	300-460	Vertical Redundant(F)			★1	4	
GH-431ATXR	x			12"x13"					7	230-700	PS/2 or Mini Redundant				4	
GH-431SR	x		x			x	x	x	14/15	230-700	PS/2 or Mini Redundant				4	
GH-432ATXR	x			12"x13"					7	230-700	PS/2 or Mini Redundant(F)			★1	4	
GH-432SR	x		x			x	x	x	19	230-700	PS/2 or Mini Redundant(F)				4	
GHI-440	x			12"x13"					7	230-700	PS/2 or Mini Redundant	★2				3
GHI-441	x			12"x13"					7	230-700	PS/2 or Mini Redundant	★2				3
GHI-442	x			12"x13"					7	230-700	PS/2 or Mini Redundant	★2				3
GHI-450	x			12"x13"					7	230-700	PS/2 or Mini Redundant				4	
GHI-480	x			12"x13"					7	950	Redundant	★2				3

Chassis Comparison Chart

Air Flow	Disk Mounting VD =Vibration Damping					Keyboard Connector		Dimensions (millimeters/inch)			Front Panel Indicator					Front Panel Controls						
	CFM/EACH	2.5" Int	3.5" Int	5.25" Int	3.5" F.P.	5.25" F.P.	Front	Rear	Width	Height	Depth	On/Off	HD Active	Over Heat	Fan Fail	P.S. Status	LAN Active	On/Off	LAN	USB	Reset	Keylock
42.5		4		1	2			x	483/19"	88/3.5"	650/25.6"	x	x	x	x		x	x	x	x		
42.5		4		1	2			x	483/19"	88/3.5"	650/25.6"	x	x	x	x		x	x	x	x		
42.5		4		1	2			x	483/19"	88/3.5"	650/25.6"	x	x	x	x		x	x	x	x		
42.5		2		1	1		x	x	483/19"	88/3.5"	526/20.7"	x	x							x	x	
42.5		1	6	△1	1		x	x	483/19"	88/3.5"	700/27.5"	x	x	x	x				x	x	x	
42.5		12						x	483/19"	88/3.5"	650/25.6"	x	x	x	x						x	
42.5		4		1	2			x	483/19"	88/3.5"	560/22.1"	x	x						x	x	x	
42.5		5		1	2			x	483/19"	133/5.2"	526/20.7"	x	x							x	x	
42.5		7+☆2		1	2			x	483/19"	133/5.2"	650/25.6"	x	x						x	x	x	x
23.5/51		7+☆2		1	2			x	483/19"	133/5.2"	526/20.7"	x	x				x		x	x	x	x
15.3/23.5/108		5		1	2			x	483/19"	133/5.2"	526/20.7"	x	x				x		x	x	x	
7/23.5/51		3			△1			x	483/19"	133/5.2"	526/20.7"	x	x				x		x	x	x	x
42.5/51		1		2	2			x	483/19"	133/5.2"	650/25.6"	x	x							x	x	
23.5/51								x	483/19"	133/5.2"	650/25.6"	x	x		x					x	x	
10.8/51		2			1			x	483/19"	133/5.2"	400/15.7"	x	x				x				x	
23.5/51		26			1			x	483/19"	133/5.2"	650/25.6"	x	x	x	x				x	x	x	
7.0/51		12		△1	△1			x	483/19"	133/5.2"	650/25.6"	x	x	x	x		x		x	x	x	
10.8/23.5/42.5		10		△1	1+△1			x	483/19"	133/5.2"	650/25.6"	x	x	x	x		x		x	x	x	
7.0/51		16		△1	△1			x	483/19"	133/5.2"	650/25.6"	x	x	x	x		x		x	x	x	
42.5		1		1	2			x	483/19"	178/7"	427/16.8"	x	x							x	x	
42.5		1		1	2			x	483/19"	178/7"	427/16.8"	x	x							x	x	
51				1	3		x	x	483/19"	178/7"	451/17.8"	x	x							x		x
51				1	3		x	x	483/19"	178/7"	451/17.8"	x	x							x		x
51				1	3		x	x	483/19"	178/7"	451/17.8"	x	x							x		x
51				1	3		x	x	483/19"	178/7"	451/17.8"	x	x							x		x
108		1+☆1			3			x	483/19"	178/7"	510/20.1"	x	x							x		x
108		1+☆1			3			x	483/19"	178/7"	510/20.1"	x	x							x	x	x
108		☆1		1	4		x	x	483/19"	178/7"	510/20.1"	x	x							x	x	x
108		☆1		1	4		x	x	483/19"	178/7"	510/20.1"	x	x							x	x	x
108		☆1		1	3			x	483/19"	178/7"	510/20.1"	x	x							x	x	x
108		☆1		1	3			x	483/19"	178/7"	510/20.1"	x	x							x	x	x
120.2/23.5		1			△1			x	483/19"	178/7"	490/19.3"	x	x							x		
108		☆1		1	3			x	483/19"	178/7"	510/20.1"	x	x							x	x	x
108		☆1		1	3			x	483/19"	178/7"	510/20.1"	x	x							x	x	x
32/90		2		1	3			x	483/19"	178/7"	510/20.1"	x	x							x	x	x
32/90		2		1	3			x	483/19"	178/7"	510/20.1"	x	x							x	x	x
23.5/51		5		1	2			x	483/19"	178/7"	510/20.1"	x	x							x	x	x
23.5/51		5		1	2			x	483/19"	178/7"	510/20.1"	x	x							x	x	x
42.5/51		☆2		1	3			x	480/18.9"	178/7"	671/26.4"	x	x							x	x	x
42.5/51		☆2		1	3			x	480/18.9"	178/7"	671/26.4"	x	x							x	x	x
51		1+☆2		1	6			x	480/18.9"	178/7"	671/26.4"	x	x							x	x	x
51		1+☆2		1	6			x	480/18.9"	178/7"	671/26.4"	x	x							x	x	x
51		2+☆2		1	3			x	480/18.9"	178/7"	671/26.4"	x	x							x	x	x
51		2+☆2		1	3			x	480/18.9"	178/7"	671/26.4"	x	x							x	x	x
90		4		1	8			x	483/19"	178/7"	624/24.5"	x	x			x	x			x	x	x
90		4		1	8			x	483/19"	178/7"	574/22.5"	x	x			x	x			x	x	x
90					10			x	483/19"	178/7"	624/24.5"	x	x			x	x			x	x	x
51		1	2	1				x	431/17"	222/8.7"	557/21.9"	x	x							x	x	x
23.5/90		☆2	16		△1	△1		x	480/18.9"	178/7"	650/25.6"	x	x	x	x		x			x	x	x

(F)=Front (H)=Horizontal (V)=Vertical ☆=Optional kit for 3.5" internal Disk Mounting ★= Optional Fan △=For Slim Type Disk

Chassis Comparison Chart

Model	Mounting Configuration options		Board Options		Bus Architecture		Max. Number of Slots	Power Supply Options		Fan space#						
	Rack	Tower	Wall/ Panel	Passive B/P	ATX/AT M/B	CPU		ISA	PCI	cPCI H. 100	Watts	P/S Type	4 cm	6 cm	8 cm	9 cm
GHI-481	x				12"x13"					7	950	Redundant	★2			3
GH-520SR	x			x			x	x	x	20	300~400	Vertical Redundant(F) or DC 48V				4
GH-530ATXR	x				12"x13"					7	300~400	Vertical Redundant(F) or DC 48V				4
GHI-580	x				12"x13"					7	500x2	Redundant	1	2		3
GHI-581	x				12"x13"					7	500x2	Redundant	2	1		3
GHI-583	x				12"x16"					7	1350/1650	1U Redundant	3			3
GHI-584	x				16"x13"					7	1350/1650	1U Redundant	6			2
GH-600ATXR	x				12"x13"					7	300~700	PS/2 or Horizontal Redundant				4
GHI-611	x			x			x	x	x	20	300~550	PS/2 or Horizontal Redundant				4
GH-620SR	x			x			x	x	x	20	250~400	PS/2 or Horizontal Redundant				4
GHI-690	x				12"x16"					7	1350/1650	1U Redundant				4
GHI-691	x				12"x16"					7	1350/1650	1U Redundant				4
GH-800ATXR	x				12"x13"					7	300~400	PS/2 or Horizontal Redundant				4
GH-820SR	x			x			x	x	x	20	300~400	PS/2 or Horizontal Redundant				4
GHI-P01	x				12"x13"					10	200~600	1Ux10				10+80
GHB-B04		x	x	x			x	x	x	4	150	Special				1
GHB-B05			x								200	1U				1
GHB-B08	x	x	x	x			x	x	x	8	250~400	PS/2 or Mini Redundant				2
GHB-042		x	x	x			x	x	x	4	200~300	1U				1
GHB-043		x	x	x			x	x	x	4	250~300	1U	1			1
GHB-060		x	x	x			x	x	x	6	230~300	PS/2 or Mini Redundant				1
GHB-061		x	x		9.6"x9.6"					4	250~300	Special				1
GHB-062-6		x	x	x			x	x	x	6	230~300	PS/2 or Mini Redundant				1
GHB-062-8		x	x	x			x	x	x	8	200~350	1U				1
GHB-080		x	x	x			x	x	x	8	230~400	PS/2 or Mini Redundant				1
GHB-082-8		x	x	x			x	x	x	8	200~400	1U				1
GHB-082-10		x	x	x			x	x	x	10	200~300	1U				1
GHB-083-8		x	x	x			x	x	x	8	200~300	1U				1
GHB-083-10		x	x	x			x	x	x	10	200~300	1U				1
GHB-120ATXR		x	x		9.6"x9.6"					7	230~400	PS/2 or Mini Redundant				1
GHB-120SR		x	x	x			x	x	x	10/12	230~400	PS/2 or Mini Redundant				1
GHC-C01	x				Compact PCI				x	2	200~400	1U	4			
GHC-C02	x				Compact PCI				x	4	200~400	1U				2
GHC-C03	x				Compact PCI				x	5	300~320	2U		1	1	
GHC-C04	x				Compact PCI				x	7	300~320	2U		1	2	
GHC-P03	x				Compact PCI				x	9	300~460	PS/2 or Mini Redundant			2	2+1
GHR-219	x				Storage						250~400	PS/2 or Mini Redundant				4
GHR-390	x										230~700	PS/2 or Mini Redundant				4
GHR-420	x				Storage						250~400	PS/2 or Mini Redundant				4
GHR-421	x				Storage						250~400	PS/2 or Mini Redundant				4
GHR-422	x				Storage						230~460	PS/2 or Mini Redundant				2
GHR-2104		x			Storage						250~400	PS/2 or Redundant				2
GHS-1500		x		x	12"x13"		x	x	x	7~14	250~1200	PS/2 or Redundant				5
GHS-2000		x		x	16"x13"		x	x	x	7~20	250~1200	PS/2 or Redundant				8
SG-1200											250~700	PS/2 or Redundant				
SG-4002XC		x		x	12"x13"		x	x	x	7~14	300~400	PS/2 or Redundant				4+★4
GT-232XC		x			12"x13"					7	250~400	PS/2 or Redundant				1+★1
GT-332BC		x			12"x13"					7	250~400	PS/2	★1			2

Chassis Comparison Chart

Air Flow	Disk Mounting VD =Vibration Damping					Keyboard Connector		Dimensions (millimeters/inch)			Front Panel Indicator					Front Panel Controls					
	CFM/EACH	2.5" Int	3.5" Int	5.25" Int	3.5" F.P.	5.25" F.P.	Front	Rear	Width	Height	Depth	On/Off	HD Active	Over Heat	Fan Fail	P.S. Status	LAN Active	On/Off	LAN	USB	Reset
23.5/90	☆2	14		△1	1+△1		x	480/18.9"	178/7"	650/25.6"	x	x	x	x		x	x	x	x		
51				1	4		x	483/19"	222/8.7"	671/26.4"	x	x	x	x	x		x		x	x	
51				1	4		x	483/19"	222/8.7"	671/26.4"	x	x	x	x	x		x		x	x	
23.5/42.5/90		24+☆2		△1	△1		x	483/19"	222/8.7"	650/25.6"	x	x	x	x		x	x	x			
23.5/42.5/90		22+☆2		△1	△1		x	483/19"	222/8.7"	650/25.6"	x	x	x	x		x	x	x			
23.5/42.5/90		24		△1	△1		x	483/19"	222/8.7"	650/25.6"	x	x	x	x		x	x	x			
23.5/90		24		△1	△1		x	483/19"	222/8.7"	650/25.6"	x	x	x	x		x	x	x			
51				1	7		x	483/19"	267/10.5"	671/26.4"	x	x	x	x	x		x		x	x	
51		1		1	4		x	483/19"	267/10.5"	671/26.4"	x	x	x	x	x		x		x	x	
51				1	7		x	483/19"	267/10.5"	671/26.4"	x	x	x	x	x		x		x	x	
51				36			x	483/19"	267/10.5"	671/26.4"	x	x	x	x	x		x		x		
51				36			x	483/19"	267/10.5"	671/26.4"	x	x	x	x	x	x	x		x		
51/108				1	7		x	483/19"	356/14"	510/20.1"	x	x	x	x	x		x		x	x	
51/108				1	7		x	483/19"	356/14"	510/20.1"	x	x	x	x	x		x		x	x	
8/15		20					x	483/19"	356/14"	830/32.7"	x	x					x	x	x	x	
51		1		1			x x	110/4.3"	267/10.5"	450/17.7"	x	x					x		x		
23.5								280/11.0"	77.0/3.0"	268/10.6"											
51		1		1	1		x x	220/8.7"	267/10.5"	450/17.7"	x	x					x		x		
51		1		1			x x	110/4.3"	267/10.5"	450/17.7"	x	x					x		x		
23.5/51		1		1	△1		x	160/6.3"	220/8.6"	260/10.2"	x	x					x		x	x	
90		☆1		1	1		x x	307/12.1"	177/7"	420/16.5"	x	x	x	x	x		x		x		
51		1		1	1		x x	307/12.1"	177/7"	420/16.5"	x	x	x	x	x		x		x	x	
90		☆1		1	1		x x	307/12.1"	177/7"	420/16.5"	x	x	x	x	x		x		x		
90		☆1		1	1		x x	307/12.1"	177/7"	420/16.5"	x	x	x	x	x		x		x		
90		1		1	2		x x	350/13.8"	177/7"	420/16.5"	x	x	x	x	x		x		x		
90		1		1	2		x x	350/13.8"	177/7"	411/16.1"	x	x	x	x	x		x		x		
90		1		1	2		x x	350/13.8"	177/7"	411/16.1"	x	x	x	x	x		x		x		
90				1			x x	280/11"	237/9.3"	260/10.2"	x	x				x	x	x	x		
90				1			x x	280/11"	237/9.3"	260/10.2"	x	x				x	x	x	x		
90		1		2	2		x x	400/15.7"	177/7"	420/16.5"	x	x	x	x			x		x		
90		1		2	2		x x	400/15.7"	177/7"	420/16.5"	x	x	x	x			x		x		
10.8								483/19"	44/1.7"	323/12.7"	x	x					x		x		
42.5		1						483/19"	88/3.5"	296/11.7"	x	x					x		x		
42.5/51		1		△1	△1			483/19"	133/5.2"	296/11.7"	x	x					x		x		
42.5/51		2		△1	△1			483/19"	178/7"	296/11.7"	x	x					x		x		
32.5/51/90				1	3			483/19"	355/14"	365/14.4"	x	x					x		x		
42.5		9						483/19"	88/3.5"	450/17.7"	x	x	x	x			x		x		
51								483/19"	88/3.5"	507/20.0"											
51				2	6			483/19"	177/7"	510/20.1"	x	x					x		x	x	
51					8			483/19"	177/7"	510/20.1"	x	x					x		x	x	
51					9			483/19"	177/7"	510/20.1"	x	x	x	x			x		x		
51					12			200/7.9"	608/24"	435/17.1"	x	x				x	x	x	x		
51					15		x	410/16.2"	416/16.4"	710/28"	x	x	x	x	x		x		x	x	
51/108					23		x	410/16.2"	600/23.6"	710/28"	x	x	x	x	x		x		x	x	
								210/8.3"	608/23.9"	650/25.6"											
51					16		x	424/16.7"	605/23.8"	435/17.1"	x	x				x	x	x	x		
51		2		3	2		x	212/8.4"	455/17.9"	435/17.2"	x	x					x		x		
23/51		4		2	4		x	212/8.4"	605/23.8"	435/17.2"	x	x					x		x		

(F)=Front (H)=Horizontal (V)=Vertical ☆=Optional kit for 3.5" internal Disk Mounting ★= Optional Fan △=For Slim Type Disk

GHI-100/101

1U Rackmount Chassis



Specifications

- **EIA RS-310C 19" Rackmount Standard**
- **Construction:** Heavy Duty Cold Rolled Electroplated Steel
- **Color:** Black (standard), Beige or Custom
- **System Boards:** 2 slot (GHI-100) or 3 slot (GHI-101) Passive Backplane
- **Drive Capacity:** (Option A): 1x Slim CD-ROM, 3.5" HDD, & 1x Slim FDD, 3.5" HDD & 1x2.5"HDD(Optional)
(Option B): 1x 5.25" & 1x 3.5" & 1x 2.5"HDD(Optional)
- **Power Supply(Optional):** 1U Single up to 350W ATX P/S (Rear Installation) Max. Depth 205mm
- **Cooling:** 3x (40x20mm = 7CFM ea.) Fans
- **Front Door:** Single Door with 2 Thumbscrews
- **Connector Port (Front):** 2x USB & 1x PS/2 Ports
- **Indicators:** LEDs for Power ON/OFF, HDD Activity
- **Switch:** Power ON/OFF Momentary (Rocker), System Reset
- **Dimensions (WxHxD):** 483x44x450mm (19" x 1.7" x 17.7")
- **Cuft:** 2.3
- **GW:** 10.0kgs / 22.1lbs
- **Carton Size(cm):** 61.5 x 17.9 x 60.0 (24.2" x 7.0" x 23.6")
- **Humidity:** 5% - 95% Non-condensing

Dimension

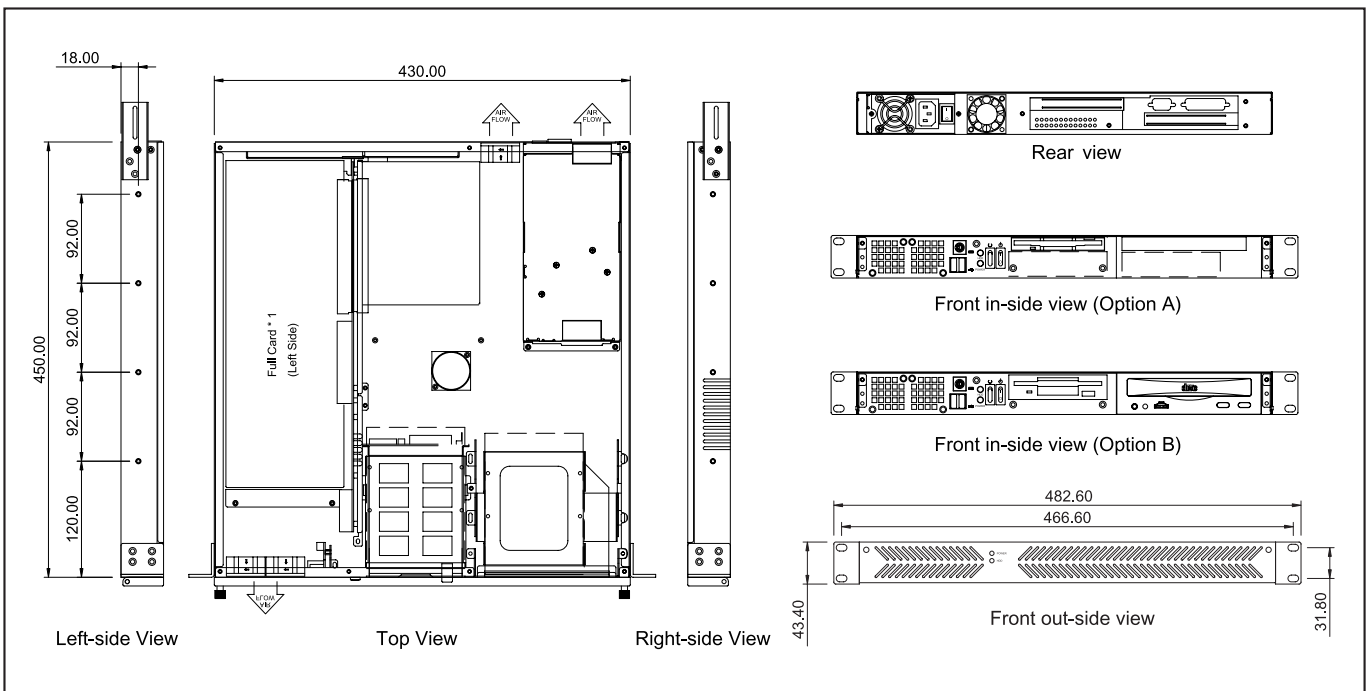

GHI-104/104DX

1 U Rackmount Chassis



Specifications

- **EIA RS-310C 19" Rackmount Standard**
- **Construction:** Heavy Duty Cold Rolled Electroplated Steel
- **Color:** Black (Standard), Beige or Custom
- **System Boards:** Dual Xeon, Pentium 4, Athlon 64, Dual Operton
- **Support EATX M/B (12"x 13") SSI EEB 3.0**
- **Drive Capacity:**
(Option A): 1x 5.25" & 1x 3.5" & 2x 3.5"HDD
(Option B): 2x 5.25" & 1x 3.5"
- **Power Supply(Optional):** 1U Single up to 500W ATX P/S(Mid Installation) Max. Depth 225mm
- **Cooling:** 3x(40 x 20mm) Fans(7.0CFM ea.) & 2x (40 x 28mm) Fans(15.3CFM ea.)(GHI-104)OR 5x (40 x 28mm = 15.3CFM ea.) Fans (GHI-104DX)
- **Front Door:** Single Door with 1 Thumbscrew
- **Riser Card:** GHP-141 (32bit) or GHP-R0103 (64bit) (Optional)
- **Connector Port(Front):** 2x USB Ports
- **Expansion Slots:** 1x Horizontal PCI Slot
- **Indicators:** LEDs for Power ON/OFF, HDD Activity
- **Switch:** Power ON/OFF Momentary (Square), System Reset
- **Dimensions (WxHxD):** 483x44x605mm(19" x 1.7" x 23.8")
- **Cuft:** 2.8
- **GW:** 10.0kgs / 22.1lbs
- **Carton Size(cm):** 74.5 x 18.5 x 57.3 (29.7" x 7.3" x 22.6")
- **Humidity:** 5% - 95% Non-condensing

Dimension

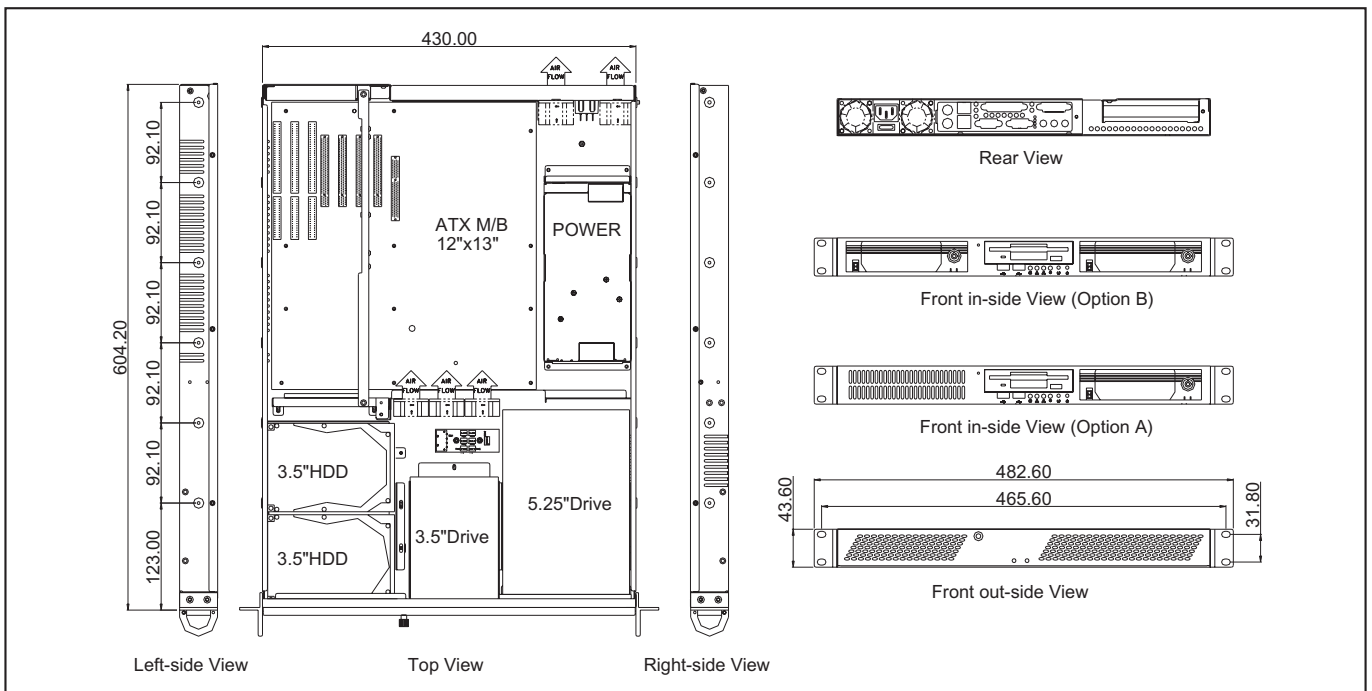

GHI-105/105DX

1U Rackmount Chassis



Specifications

- **EIA RS-310C 19" Rackmount Standard**
- **Construction:** Heavy Duty Cold Rolled Electroplated Steel
- **Color:** Black (Standard), Beige or Custom
- **System Boards:** Dual Xeon, Pentium 4, Athlon 64, Opteron
- **Support ATX M/B (Max. to 12" x 10.5")**
- **Drive Capacity:**
 (Option A): 1x 5.25" & 1x 3.5" & 2x 3.5" HDD
 (Option B): 2x 5.25" & 1x 3.5"
- **Power Supply (Optional):** 1U Single up to 500W ATX P/S (Mid Installation) Max. Depth 215mm
- **Cooling:** 3x (40 x 20mm = 7CFM ea.) & 2x (40 x 28mm = 15.3CFM ea.) Fans (GHI-105), 5x (40 x 28mm = 15.3CFM ea.) Fans (GHI-105DX), Extra 2x 40mm Mid Installation Fans (Optional)
- **Front Door:** Single Door with 1 Thumbscrew
- **Riser Card:** GHP-141 (32bit) or GHP-R0103 (64bit) (Optional)
- **Connector Port (Front):** 2x USB Ports
- **Expansion Slots:** 1x Horizontal PCI Slot
- **Indicators:** LEDs for Power ON/OFF, HDD Activity
- **Switch:** Power ON/OFF Momentary (Square), System Reset
- **Dimensions (WxHxD):** 483x44x542mm (19" x 1.7" x 21.3")
- **Cuft:** 2.6
- **GW:** 14.0kgs / 30.9lbs
- **Carton Size (cm):** 68.5 x 18.5 x 57.3 (27" x 7.3" x 22.6")
- **Humidity:** 5% - 95% Non-condensing

Dimension

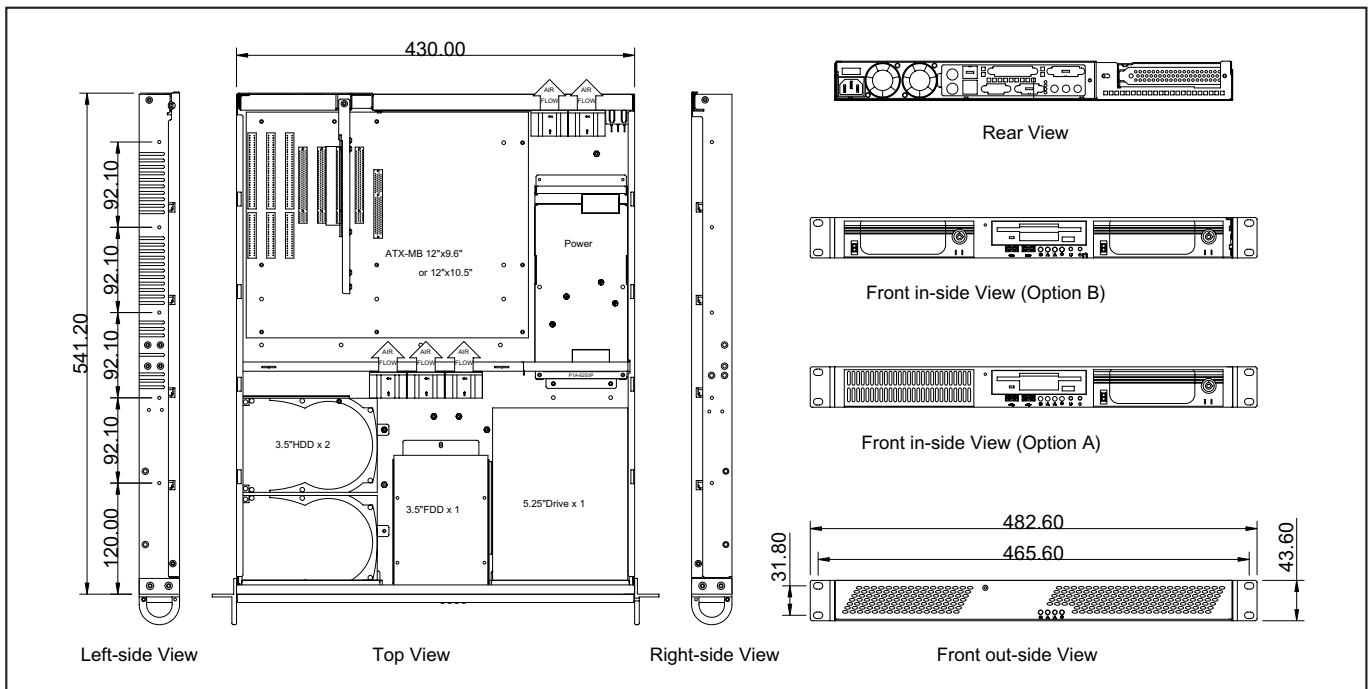

GHI-106

1 U Rackmount Chassis



Specifications

- **EIA RS-310C 19" Rackmount Standard**
- **Construction:** Heavy Duty Cold Rolled Electroplated Steel
- **Color:** Black (Standard), Beige or Custom
- **Support Mini-ITX M/B (Max. to 6.7"X 6.7")**
- **Drive Capacity:**
(Option A): 1x Slim CD-ROM, 1x Slim FDD, 1x 2.5"HDD
(Option B): 1x Slim CD-ROM, 1x 3.5" HDD
- **Power Supply(Optional):** 1U Single 200W ATX P/S(Rear Installation) Max. Depth 150mm
- **Cooling:** 2 x (40 x 20mm = 7CFM ea) Fans (Optional)
- **Riser Card:** GHP-141 (Optional)
- **Connector Port(Front):** 2xUSB Ports
- **Indicators:** LEDs for Power ON/OFF, HDD Activity
- **Switch:** Power ON/OFF Momentary (Square), System Reset
- **Dimensions (WxHxD):** 483x43x220mm(19" x 1.7" x 8.7")
- **Cuft:** 1.3
- **GW:** 4.8kgs / 10.6lbs
- **Carton Size(cm):** 57.3 x 18.5 x 35.5 (22.6" x 7.3" x 14.0")
- **Humidity :** 5% - 95% Non-condensing

Dimension

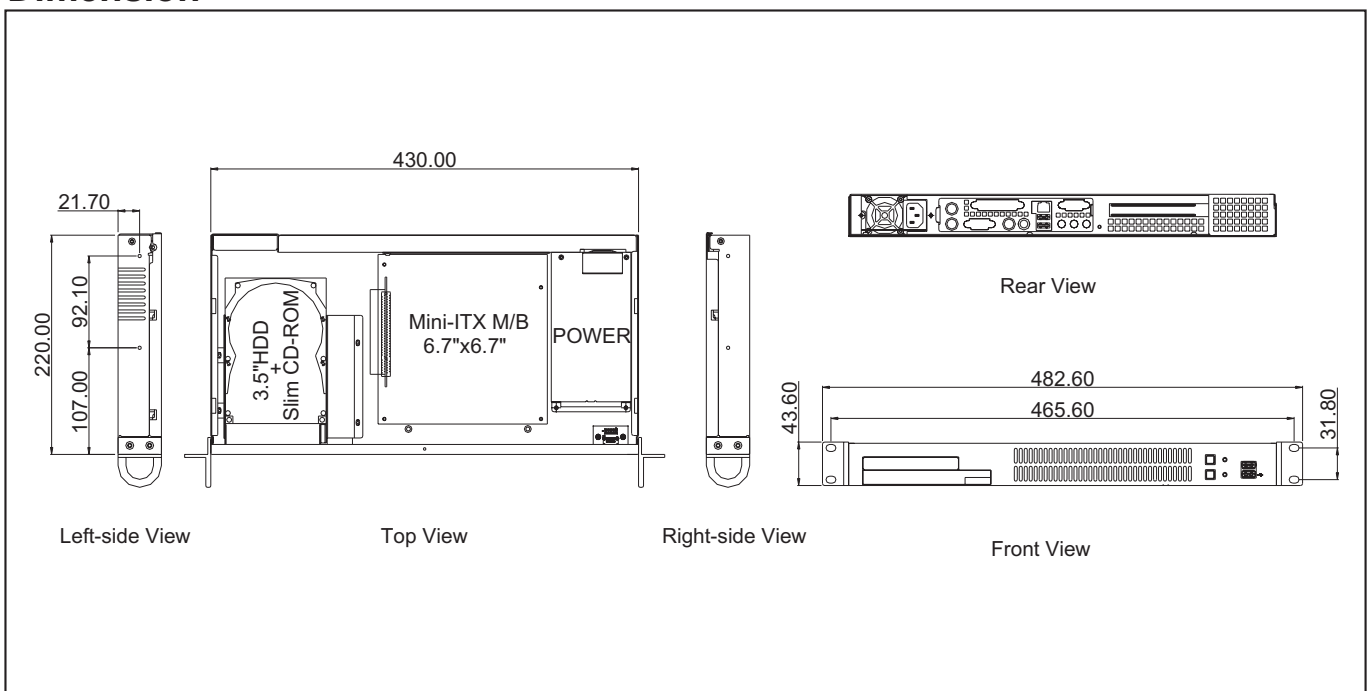

GHI-107

1U Rackmount Chassis



Specifications

- **EIA RS-310C 19" Rackmount Standard**
- **Construction:** Heavy Duty Cold Rolled Electroplated Steel
- **Color:** Black (Standard), Beige or Custom
- **System Boards:** Dual Xeon, Dual Operton, Pentium 4, Dual Pentium III
- **Support EATX M/B (Max. to 12" x 9.6") SSI EEB 3.0**
- **Drive Capacity:** 2x 3.5" HDD
- **Power Supply(Optional):** 1U 250~400W ATX P/S, Max Depth 190mm
- **Cooling:** 2x (40 x 28mm = 15.3CFM ea.) Fans
- **Expansion Slots:** 1x Horizontal PCI Slot
- **Indicators:** LEDs for Power ON/OFF, HDD Activity
- **Switch:** Power ON/OFF System Reset
- **Dimensions (W x H x D):** 483 x 44 x 382mm (19.0" x 1.7" x 15.0")
- **Cuft:** 2.0
- **GW:** 7.6kgs / 16.8lbs
- **Carton Size(cm):** 53.5 x 18.0 x 58.3 (21.1" x 7.1" x 23.0")
- **Humidity:** 5% - 95% Non-condensing

Dimension

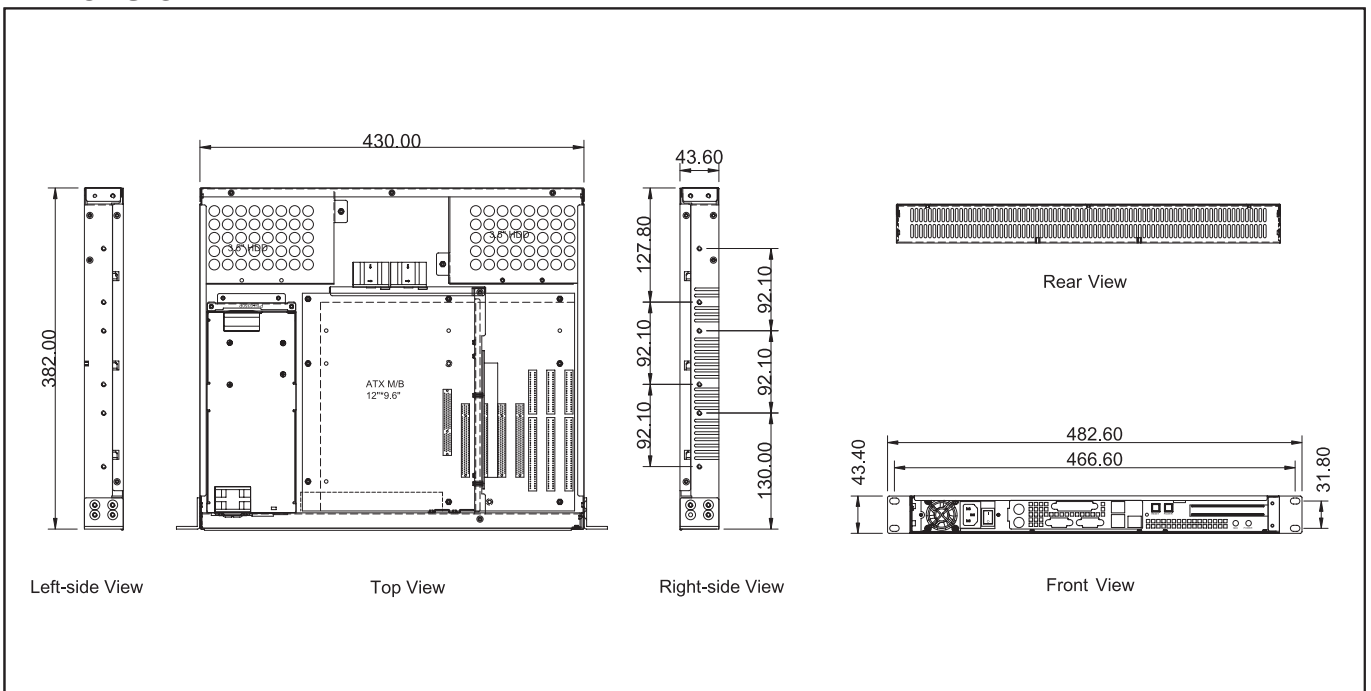

GHI-110

1U Rackmount Chassis



Specifications

- **EIA RS-310C 19" Rackmount Standard**
- **Construction:** Heavy Duty Cold Rolled Electroplated Steel
- **Color:** Black (Standard), Beige or Custom
- **System Boards:** Pentium 4
- **Support ATX M/B (Max. to 12" x 9.6")**
- **Drive Capacity:** (Option A): 1x Slim CD-ROM, 3.5"HDD & 1x Slim FDD, 3.5"HDD & 1x 3.5"HDD
(Option B): 1x5.25" & 1x3.5"FDD & 1x3.5"HDD
- **Power Supply(Optional):** 1U Single up to 350W ATX P/S(Rear Installation) Max. Depth 205mm
- **Cooling:** 2x (40 x 20mm = 7CFM ea.) & 3x (40 x 10mm) Fans
- **Front Door:** Single Door With 1 Thumbscrew
- **Riser Card:** GHP-141(32Bit) or GHP-R0103(64Bit) (Optional)
- **Connector Port(Front):** 2x USB & 1x PS2 Ports
- **Expansion Slots:** 1x Horizontal PCI Slot
- **Indicators:** LEDs for Power ON/OFF, HDD Activity
- **Switch:** Power ON/OFF Momentary (Rocker), System Reset
- **Dimensions (WxHxD):** 483x44x450mm(19" x 1.7" x 17.7")
- **Cuft:** 2.3
- **GW:** 10.0kgs / 22.1lbs
- **Carton Size(cm):** 61.5 x 17.9 x 60 (24.2" x 7.1" x 23.6")
- **Humidity :** 5% - 95% Non-condensing

Dimension

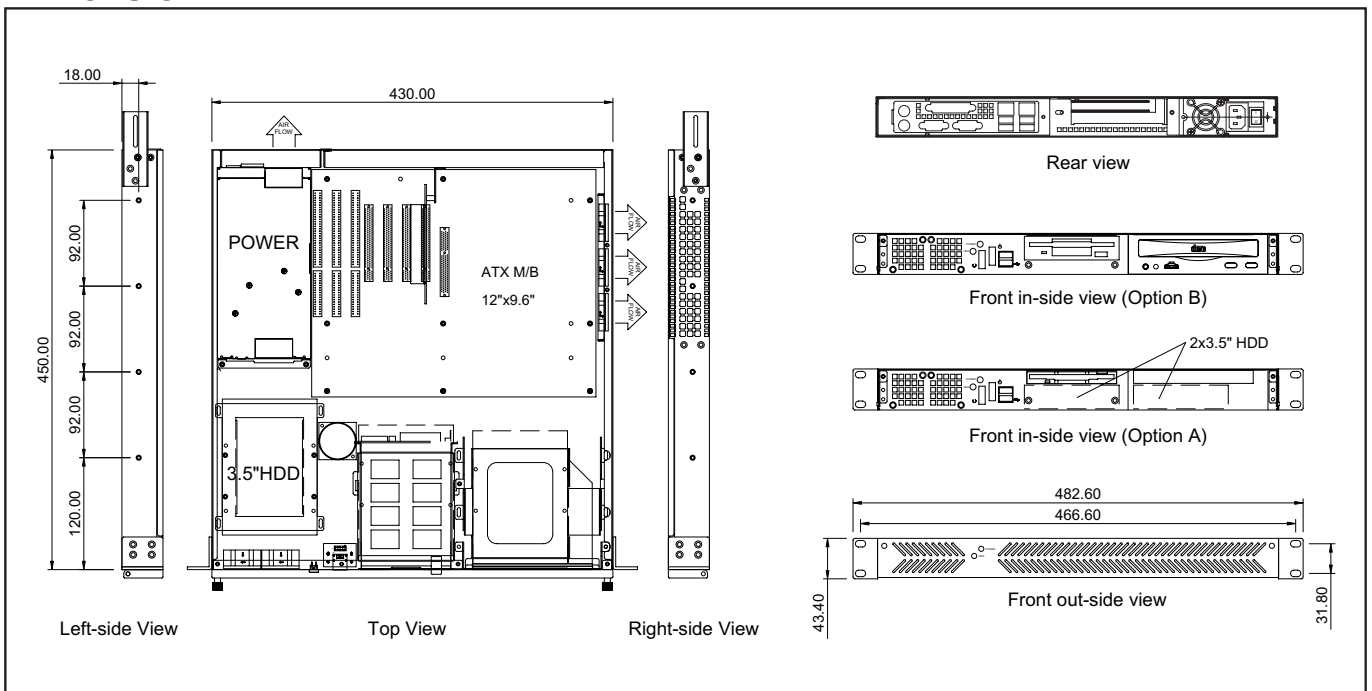

GHI-112

1 U Rackmount Chassis



Specifications

- **EIA RS-310C 19" Rackmount Standard**
- **Construction:** Heavy Duty Cold Rolled Electroplated Steel
- **Color:** Black (Standard), Beige or Custom
- **System Boards:** Pentium 4, Dual Xeon, Athlon 64, Opteron
- **Support ATX M/B (Max. to 12" x 9.6")**
- **Drive Capacity:** 1x Slim CD-ROM & 1x Slim FDD & 1x 3.5"HDD
- **Power Supply(Optional):** 1U Single up to 350W ATX P/S (Rear Installation) Max. Depth 205mm
- **Cooling:** 3x (40 x 28mm = 15.3CFM ea.) Fans
- **Connector Port(Front):** 2x USB Ports
- **Front Door:** Single Door With 1 Thumbscrew
- **Riser Card:** GHP-141 (32bit) or GHP-R0103 (64bit) (Optional)
- **Expansion Slots:** 1x Horizontal PCI Slot
- **Indicators:** LEDs for Power ON/OFF, HDD Activity
- **Switch:** Power ON/OFF Momentary (Oval), System Reset
- **Dimensions (W x H x D):** 483 x 44 x 407mm (19" x 1.7" x 16.0")
- **Cuft:** 2.1
- **GW:** 7.0kgs / 15.4lbs
- **Carton Size(cm):** 58.0 x 18.5 x 55.5 (22.8" x 7.3" x 21.9")
- **Humidity :** 5% - 95% Non-condensing

Dimension

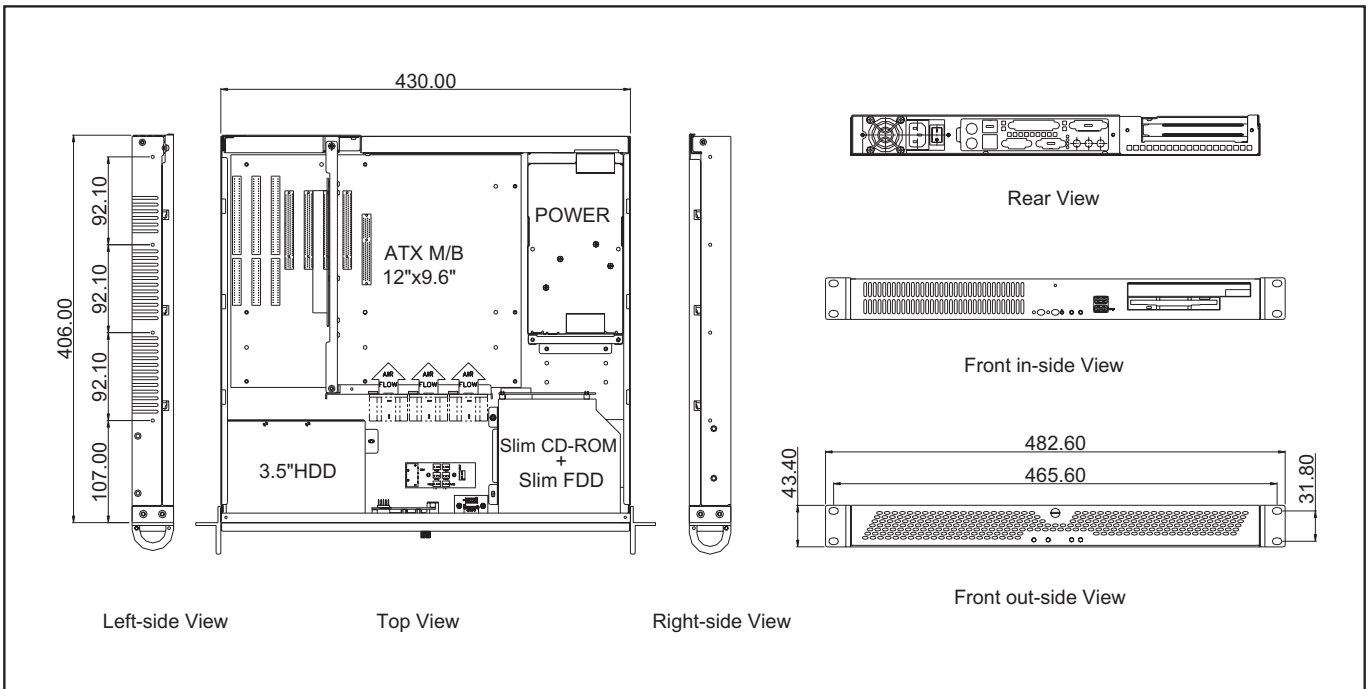

GHI-113

1U Rackmount Chassis



19" Rackmount

Specifications

- **EIA RS-310C 19" Rackmount Standard**
- **Construction:** Heavy Duty Cold Rolled Electroplated Steel
- **Color:** Black (Standard), Beige or Custom
- **System Boards:** Dual Xeon, Pentium 4, Athlon 64, Dual Opteron
- **Support EATX M/B (Max. to 12" x 13") SSI EEB 3.0**
- **Drive Capacity:**
(Option A): 1x 5.25", 1x 3.5" Open & 1x 3.5" Swappable
(Option B): 1x 5.25" & 2x 3.5" Swappable
- **Drive Interface:** PATA, SATA, SCSI320 or SAS
- **Power Supply(Optional):** 1U Single up to 500W ATX P/S(Mid Installation) Max. Depth 250mm
- **Cooling:** 7x (40 x 28mm = 15.3CFM ea.) Fans
- **Front Door:** Single Door with 1 Thumbscrew
- **Riser Card:** GHP-141 (32bit) or GHP-R0103 (64bit) (Optional)
- **Connector Port(Front):** 2x USB Ports
- **Expansion Slots:** 1x Horizontal PCI Slot
- **Indicators:** LEDs for Power ON/OFF, HDD Activity
- **Switch:** Power ON/OFF Momentary (Square), System Reset
- **Dimensions (WxHxD):** 483x44x650mm(19" x 1.7" x 25.6")
- **Cuft:** 3.1
- **GW:** 14.5kgs / 32lbs
- **Carton Size(cm):** 59.4 x 18.2 x 81.8 (23.4" x 7.2" x 32.2")
- **Humidity:** 5% - 95% Non-condensing

Dimension

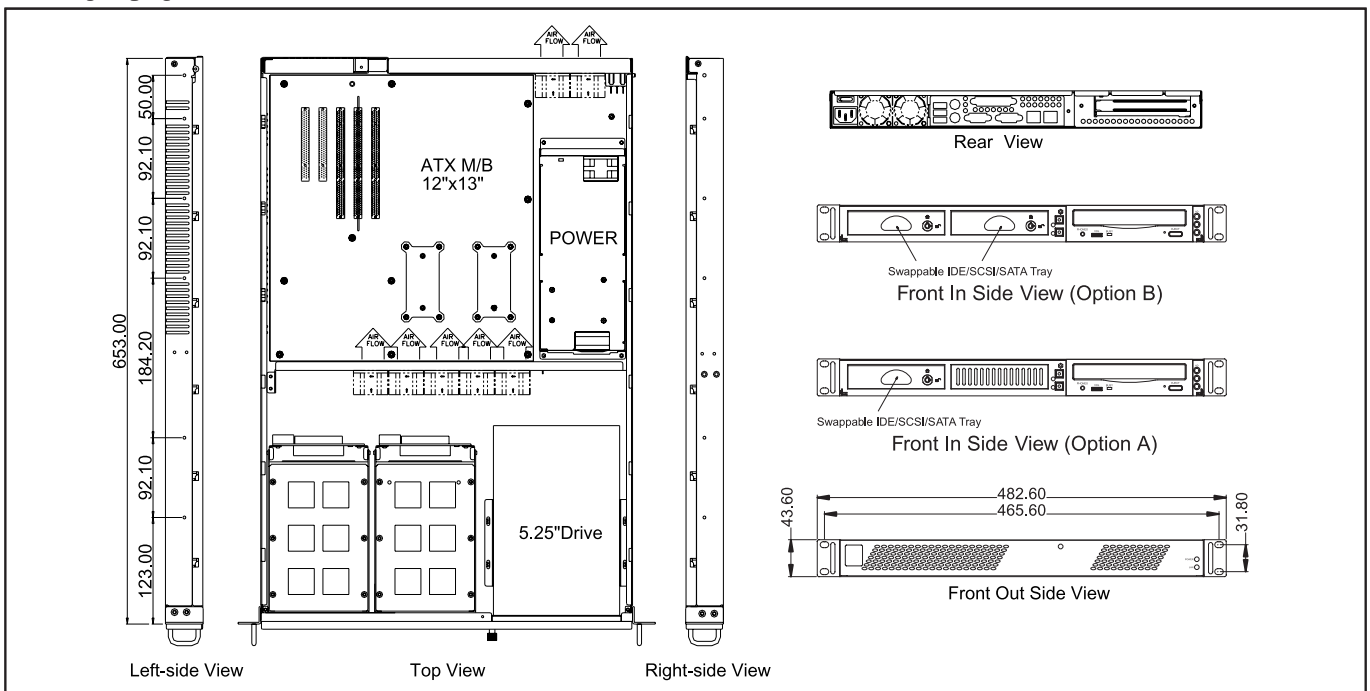

GHI-114

1 U Rackmount Chassis

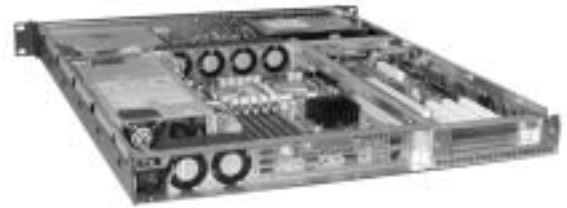

Specifications

- **EIA RS-310C 19" Rackmount Standard**
- **Construction:** Heavy Duty Cold Rolled Electroplated Steel
- **Color:** Black (Standard), Beige or Custom
- **System Boards:** Dual Xeon, Pentium 4, Athlon 64, Dual Opteron
- **Support EATX M/B (Max. to 12" x 13") SSI EEB 3.0**
- **Drive Capacity:** 1x Slim CD-ROM & 1x Slim FDD & 1x 3.5" HDD
- **Power Supply(Optional):** 1U Single up to 500W ATX P/S(Mid Installation) Max. Depth 225mm
- **Cooling:** 6x (40 x 28mm = 15.3CFM ea.) Fans
- **Front Door:** Single Door with 1 Thumbscrew
- **Riser Card:** GHP-141(32bit) or GHP-R0103(64bit) (Optional)
- **Connector Port(Front):** 2x USB Ports
- **Expansion Slots:** 1xHorizontal PCI Slot
- **Indicators:** LEDs for Power ON/OFF, LAN, HDD Activity
- **Switch:** Power ON/OFF Momentary (Oval), System Reset
- **Dimensions (WxHxD):** 483x44x543mm(19" x 1.7" x 21.4")
- **Cuft:** 2.5
- **GW:** 10.0kgs / 22.1lbs
- **Carton Size(cm):** 67.1 x 18.5 x 56.0 (26.4" x 7.3" x 22.1")
- **Humidity:** 5% - 95% Non-condensing

Dimension

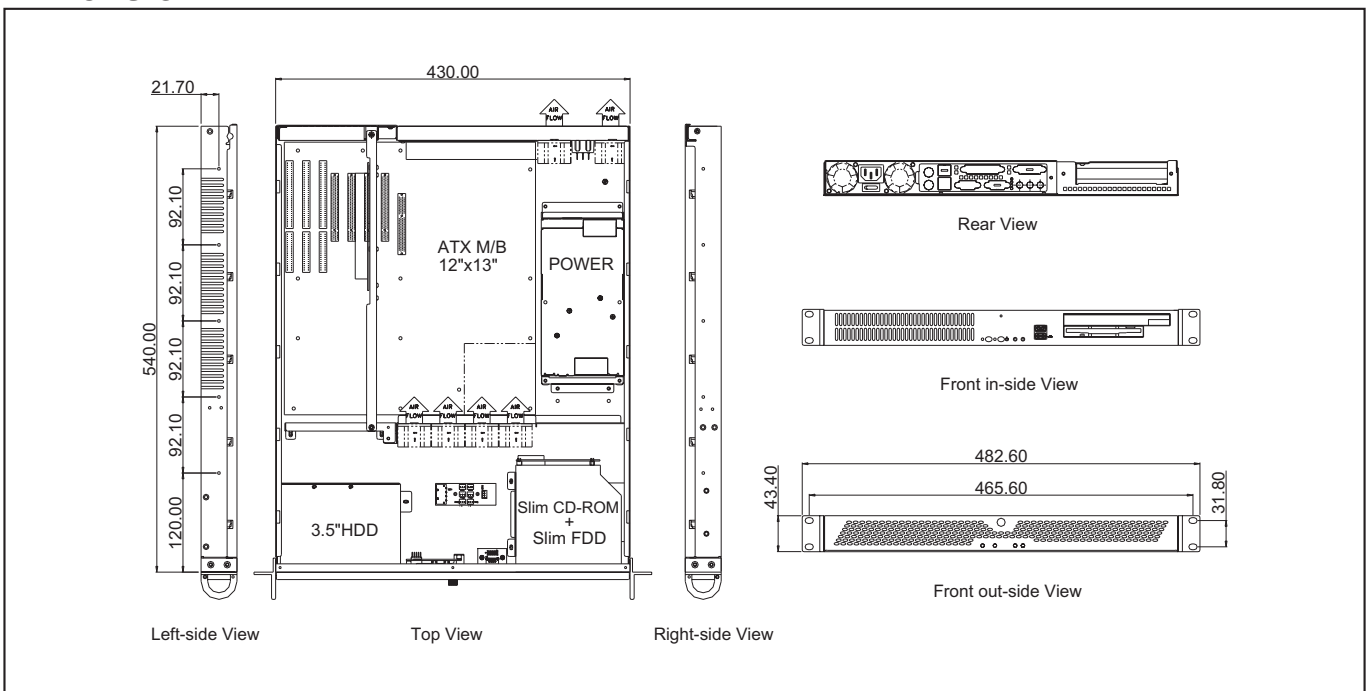

GHI-130

1 U Rackmount Chassis



19" Rackmount

Specifications

- **EIA RS-310C 19" Rackmount Standard**
- **Construction:** Heavy Duty Cold Rolled Electroplated Steel
- **Color:** Black (Standard), Beige or Custom
- **System Boards:** Pentium 4, Dual Pentium III
- **Support EATX M/B (Max. to 12" x 13")**
- **Drive Capacity:** 1x Slim CD-ROM & 1x Slim FDD & 3x 3.5" Hot Swappable SCSI 320 Trays
- **Drive Interface:** SCSI320
- **Power Supply(Optional):** 1U Single up to 300W ATX P/S(Rear Installation) Max. Depth 205mm
- **Cooling:** 6x (40 x 20mm = 7CFM ea.) & 3x (40 x 10mm) Fans
- **Front Door:** Single Door with 2 Thumbscrews
- **Riser Card:** GHP-141 (32bit) or GHP-R0103 (64bit) (Optional)
- **Expansion Slots:** 1x Horizontal PCI Slot
- **Thermal Management Card:** GHA-CO02
- **Indicators:** LEDs for Power ON/OFF, LAN, HDD Activity, Fans, Temperature
- **Switch:** Power ON/OFF Momentary (Square), System Reset, Buzzer Reset
- **Dimensions (WxHxD):** 483x44x650mm (19" x 1.7" x 25.6")
- **Cuft:** 3.1
- **GW:** 14.5kgs / 32.0lbs
- **Carton Size(cm):** 59.4 x 18.2 x 81.8 (23.4" x 7.2" x 32.2")
- **Humidity:** 5% - 95% Non-condensing

Dimension

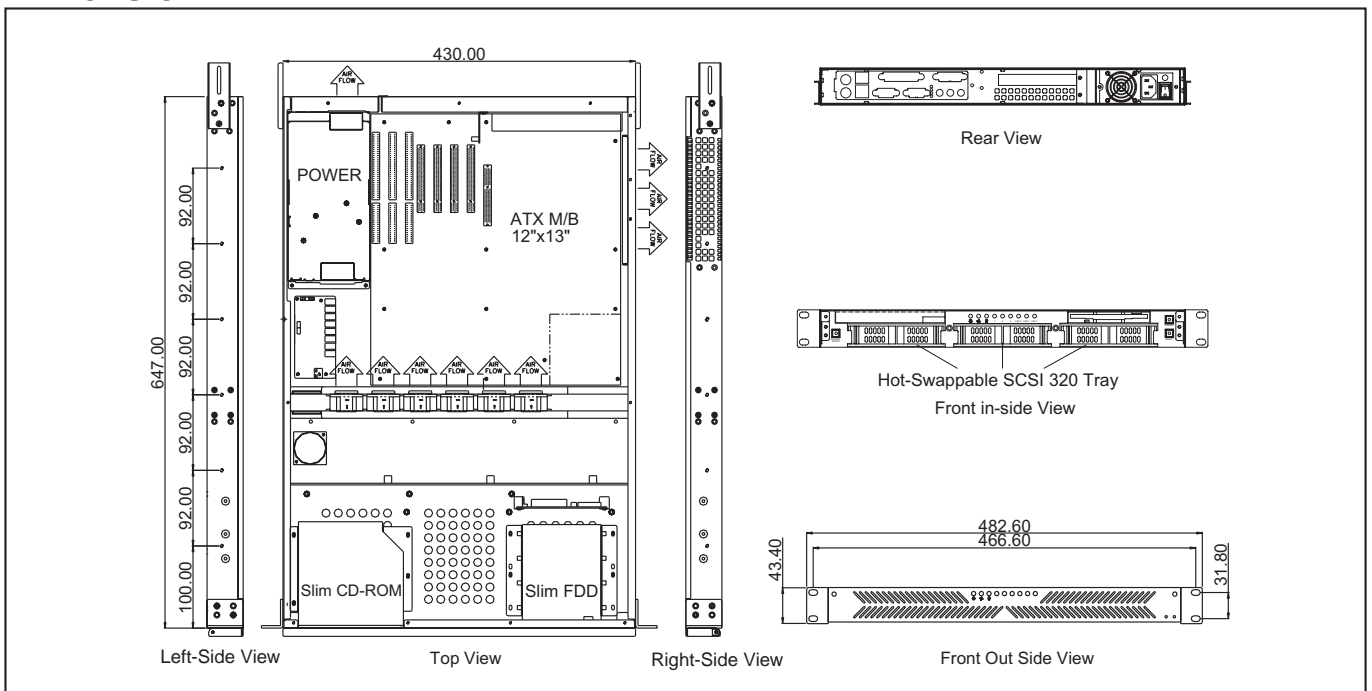

GHI-142

1 U Rackmount Chassis



Specifications

- **EIA RS-310C 19" Rackmount Standard**
- **Construction:** Heavy Duty Cold Rolled Electroplated Steel
- **Color:** Black (Standard), Beige or Custom
- **Support EATX M/B (Max. to 12" x 13")**
- **Drive Capacity:** 1x Slim CD-ROM & 1x Slim FDD
(or 1x5.25" CD-ROM) & 2x 3.5" HDD
- **Power Supply(Optional):** 1U Redundant up to 400W ATX P/S(Front Installation)
- **Cooling:** 7x (40x28 mm = 15.3CFM ea.) Fans
- **Connector Port(Front):** 2x USB Ports
- **Riser Card:** GHP-141(32bit) or GHP-R0103(64bit)
(Optional)
- **Expansion Slots:** 1x Horizontal PCI Slot
- **Thermal Management Card:** GHA-CO04
- **Indicators:** LEDs for Power ON/OFF, LAN, HDD Activity, Fans, Temperature
- **Switch:** Power ON/OFF Momentary (Rocker), System Reset, Buzzer Reset
- **Dimensions (WxHxD):** 483x44x650mm (19" x 1.7" x 25.6")
- **Cuft:** 3.1
- **GW:** 14.5kgs / 32.0lbs
- **Carton Size(cm):** 59.4 x 18.2 x 81.8(23.4" x 7.2" x 32.2")
- **Humidity:** 5% - 95% Non-condensing

Dimension

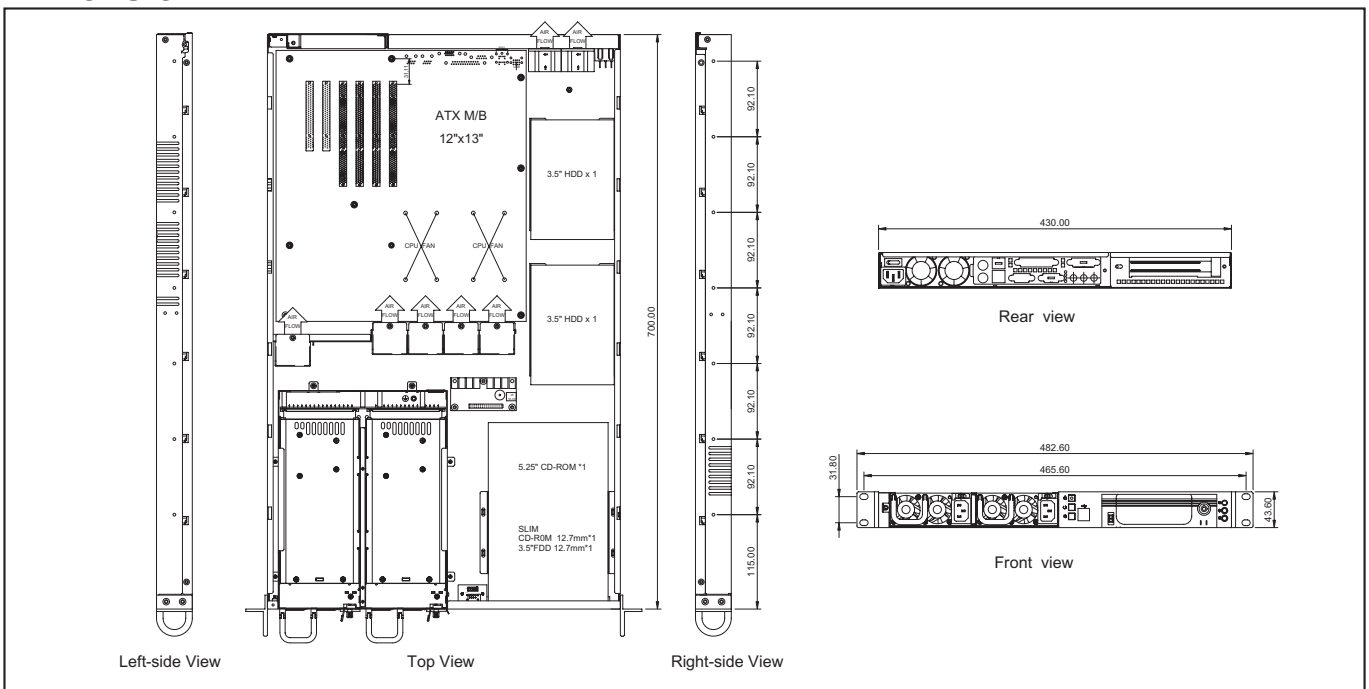

GHI-160

1 U Rackmount Chassis



19" Rackmount

Specifications

- **EIA RS-310C 19" Rackmount Standard**
- **Construction:** Heavy Duty Cold Rolled Electroplated Steel
- **Color:** Black (Standard), Beige or Custom
- **System Boards:** Pentium 4, Dual Xeon, Athlon 64, Dual Opteron
- **Supports EATX M/B (Max. to 12" x 13") SSI EEB 3.0**
- **Drive Capacity:** 8x Hot Swap 2.5" Drive Tray & 1x Slim CD-ROM & 1x 2.5"HDD
- **Drive Interface:** SCSI320 or SAS
- **Power Supply (Optional):** 1U Single up to 500W ATX P/S (Mid Installation) Max. Depth 225mm
- **Cooling:** 6x (40x28mm = 15.3CFM ea.) Fans
- **Front Door:** Single Door with 1 Thumbscrew
- **Riser Card:** GHP-141 (32bit) or GHP-R0103 (64bit) (Optional)
- **Connector Port (Front):** 2x USB Ports
- **Expansion Slots:** 1x Horizontal PCI Slot
- **Thermal Management Card:** GHA-CO02
- **Indicators:** LEDs for Power ON/OFF, HDD Activity, Fan, Temperature
- **Switch:** Power ON/OFF Momentary (Pushbutton), System Reset, Buzzer Reset
- **Dimensions (WxHxD):** 483x444x650mm(19" x 1.75" x 25.6")
- **Cuft:** 3.1
- **GW:** 12.8kgs / 28.2 lbs
- **Carton Size (cm):** 59.4 x 18.2 x 81.8 (23.4" x 7.2" x 32.2")
- **Humidity:** 5% - 95% Non-condensing

Dimension

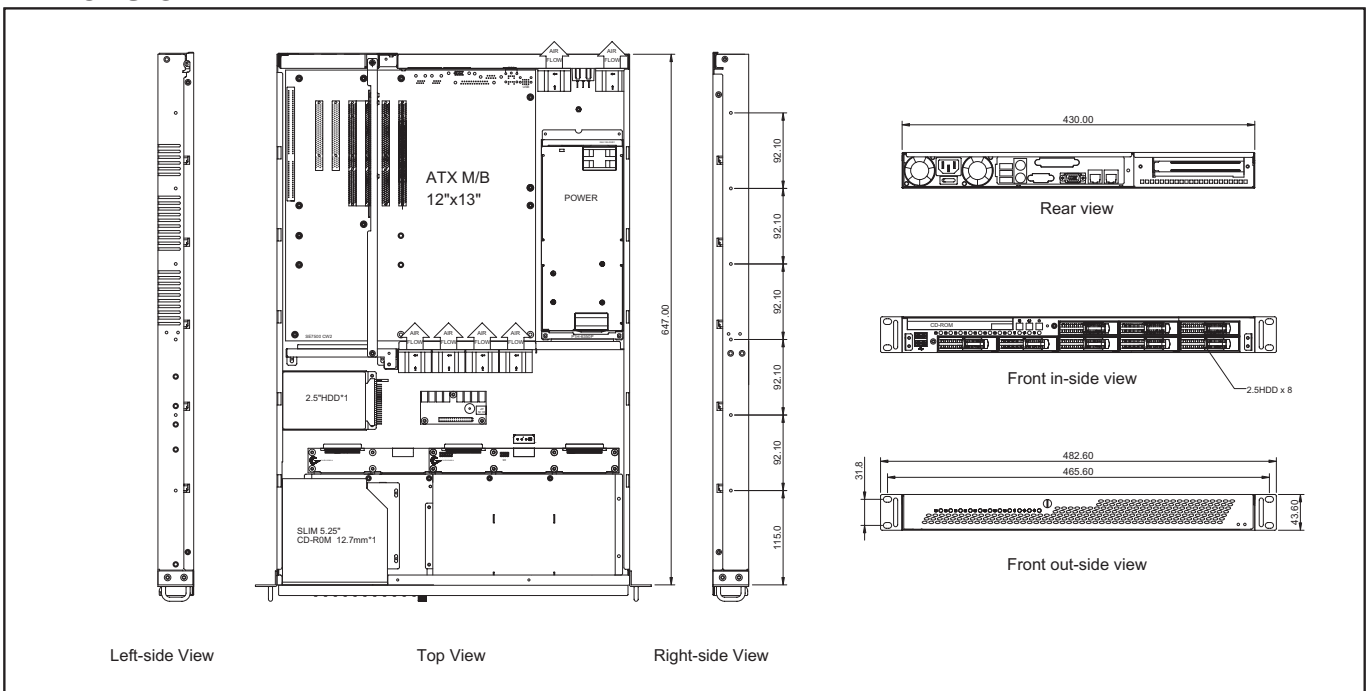

GHI-180

1 U Rackmount Chassis



Specifications

- **EIA RS-310C 19" Rackmount Standard**
- **Construction:** Heavy Duty Cold Rolled Electroplated Steel
- **Color:** Black (Standard), Beige or Custom
- **System Boards:** Dual Xeon, Dual Operton, Pentium 4, Dual Pentium III
- **Support EATX M/B (Max. to 12" x 13") SSI EEB 3.0**
- **Drive Capacity:** 1x Slim CD-ROM & 1x Slim FDD & 4x 3.5"Swappable
- **Drive Interface:** PATA, SATA, SCSI320, Multilane SATA or SAS
- **Power Supply(Optional):** 1U Single up to 400W ATX P/S(Mid Installation) Max. Depth 225mm
- **Cooling:** 6x (40 x 28mm = 15.3CFM ea.) Fans
- **Front Door:** Single Door with 1 Thumbscrew
- **Riser Card:** GHP-141 (32bit) or GHP-R0103 (64bit) (Optional)
- **Connector Port(Front):** 2x USB Ports
- **Expansion Slots:** 1x Horizontal PCI Slot
- **Indicators:** LEDs for Power ON/OFF, LAN, HDD Activity, Fans, Temperature
- **Switch:** Power ON/OFF Momentary (Pushbutton), System Reset, Buzzer Reset
- **Dimensions (WxHxD):** 483x44x650mm(19" x 1.7" x 25.6")
- **Cuft:** 2.9
- **GW:** 12.8kgs / 28.2lbs
- **Carton Size(cm):** 54.9 x 18.2 x 81.8 (23.4" x 7.2" x 32.2")
- **Humidity:** 5% - 95% Non-condensing

Dimension

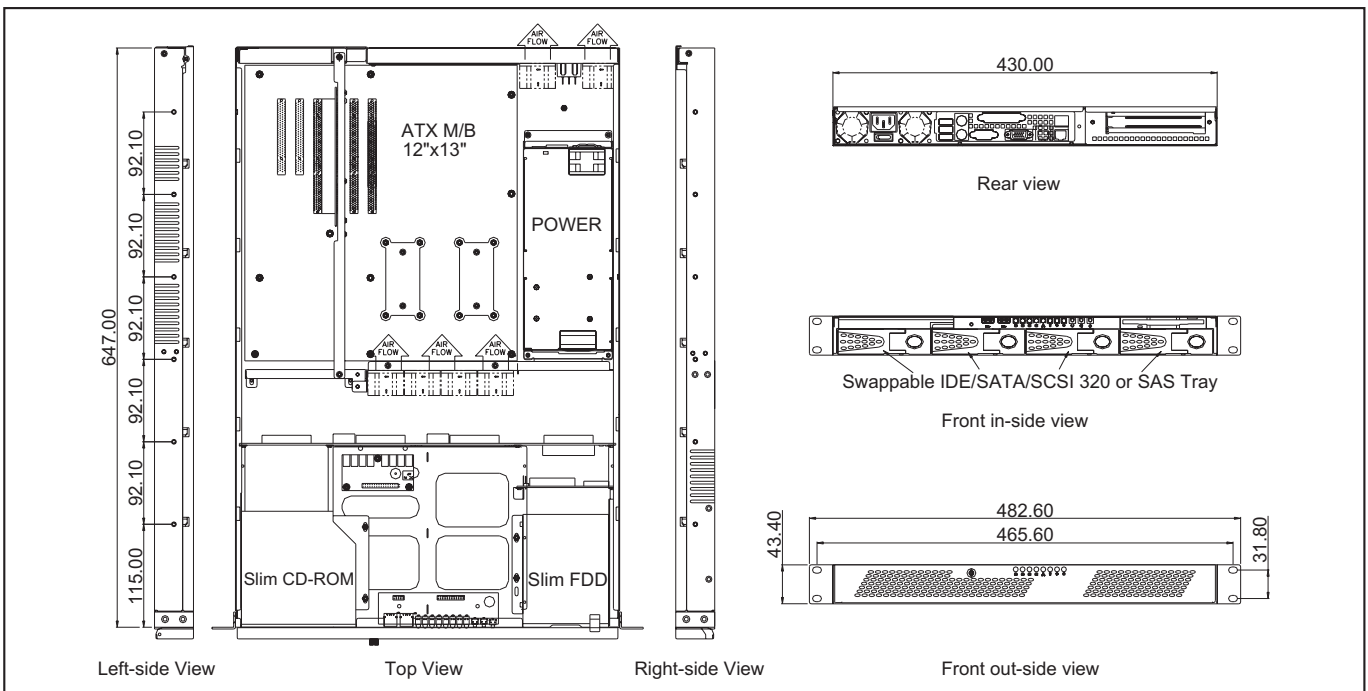

GHI-181/181WV2

1 U Rackmount Chassis



Specifications

- **EIA RS-310C 19" Rackmount Standard**
- **Construction:** Heavy Duty Cold Rolled Electroplated Steel
- **Color:** Black (Standard), Beige or Custom
- **System Boards:** Dual Xeon, Pentium 4, Dual Pentium III
- **Support EATX M/B (Max. to 12" x 13") SSI EEB 3.0**
- **Drive Capacity:**
(Option A): 1x 5.25", 1x 3.5" Open & 1x 3.5" Swappable
(Option B): 1x 5.25" & 2x 3.5" Swappable
- **Drive Interface:** PATA, SATA, SCSI320 or SAS
- **Power Supply(Optional):** 1U Single up to 500W ATX P/S(Mid Installation) Max. Depth 225mm
- **Cooling:** 6x (40 x 28mm = 15.3CFM ea.) Fans,
1x (40 x 28mm = 15.3CFM ea.) Fans (Optional)
- **Front Door:** Single Door with 1 Thumbscrew
- **Riser Card:** GHP-141 (32bit) or GHP-R0103 (64bit) (Optional)
- **Connector Port (Front):** 2x USB Ports
- **Expansion Slots:** 1x Horizontal PCI Slot (GHI-181)
2x Horizontal PCI Slot (GHI-181WV2)(Optional)
- **Indicators:** LEDs for Power ON/OFF, LAN, HDD Activity, Fans, Temperature
- **Switch:** Power ON/OFF Momentary (Square), System Reset, Buzzer Reset
- **Dimensions (WxHxD):** 483x44x650mm (19" x 1.7" x 25.6")
- **Cuft:** 2.9
- **GW:** 12.8kgs / 28.2lbs
- **Carton Size(cm):** 59.4 x 18.2 x 81.8 (23.4" x 7.2" x 32.2")
- **Humidity:** 5% - 95% Non-condensing

Dimension

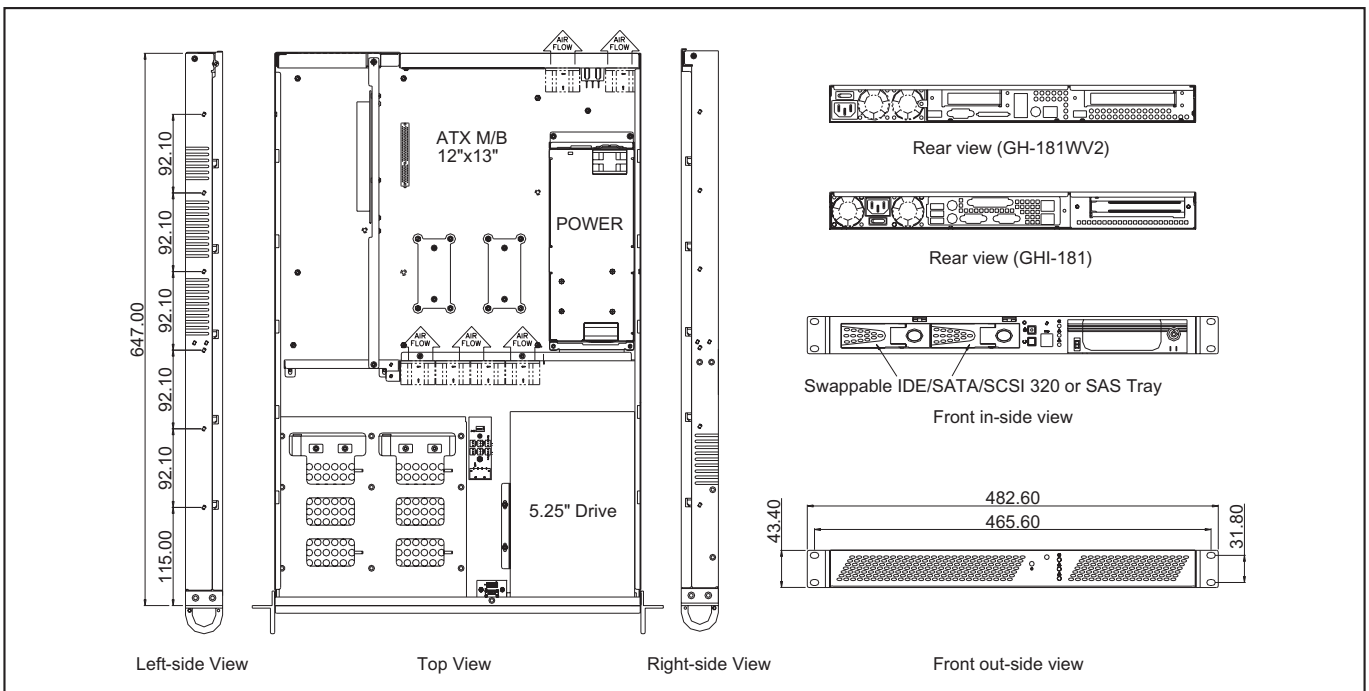

GH-188ATX

1U Rackmount Chassis

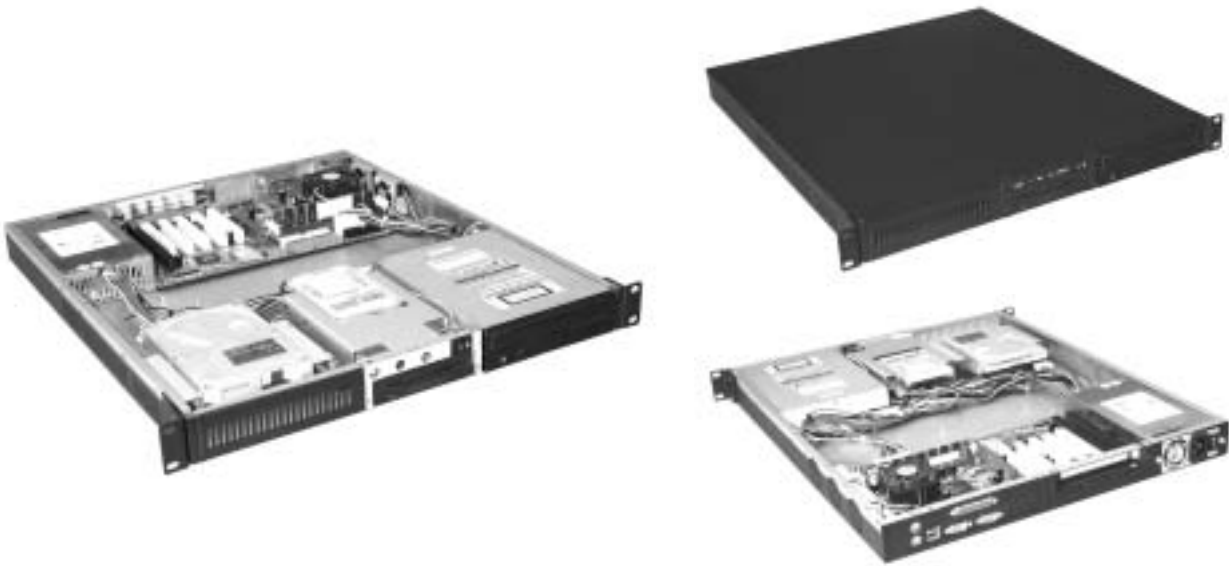

Specifications

- **EIA RS-310C 19" Rackmount Standard**
- **Construction:** Heavy Duty Cold Rolled Electroplated Steel
- **Color:** Black (Standard), Beige or Custom
- **System Boards:** Pentium 4
- **Support ATX M/B (Max. to 12" x 9.6")**
- **Drive Capacity:** 2x 5.25" & 1x 3.5" & 1x 2.5" HDD
- **Power Supply(Optional):** 1U Single up to 300W ATX P/S (Rear Installation) Max. Depth 205mm
- **Cooling:** 2x (40 x 20mm = 7CFM ea.) Fans, 1x (40 x 20mm = 7CFM ea.) Fans (Optional)
- **Riser Card:** GHP-141 (32bit) or GHP-R0103 (64bit) (Optional)
- **Expansion Slots:** 1x Horizontal PCI Slot
- **Indicators:** LEDs for Power ON/OFF, HDD Activity
- **Switch:** Power ON/OFF Momentary (Rocker), System Reset
- **Dimensions (WxHxD):** 483x44x520mm(19" x 1.7" x 20.5")
- **Cuft:** 2.5
- **GW:** 8.0kgs / 17.6lbs
- **Carton Size(cm):** 57.5 x 18.5 x 66.7(22.6" x 7.3" x 26.3")
- **Humidity:** 5% - 95% Non-condensing

Dimension

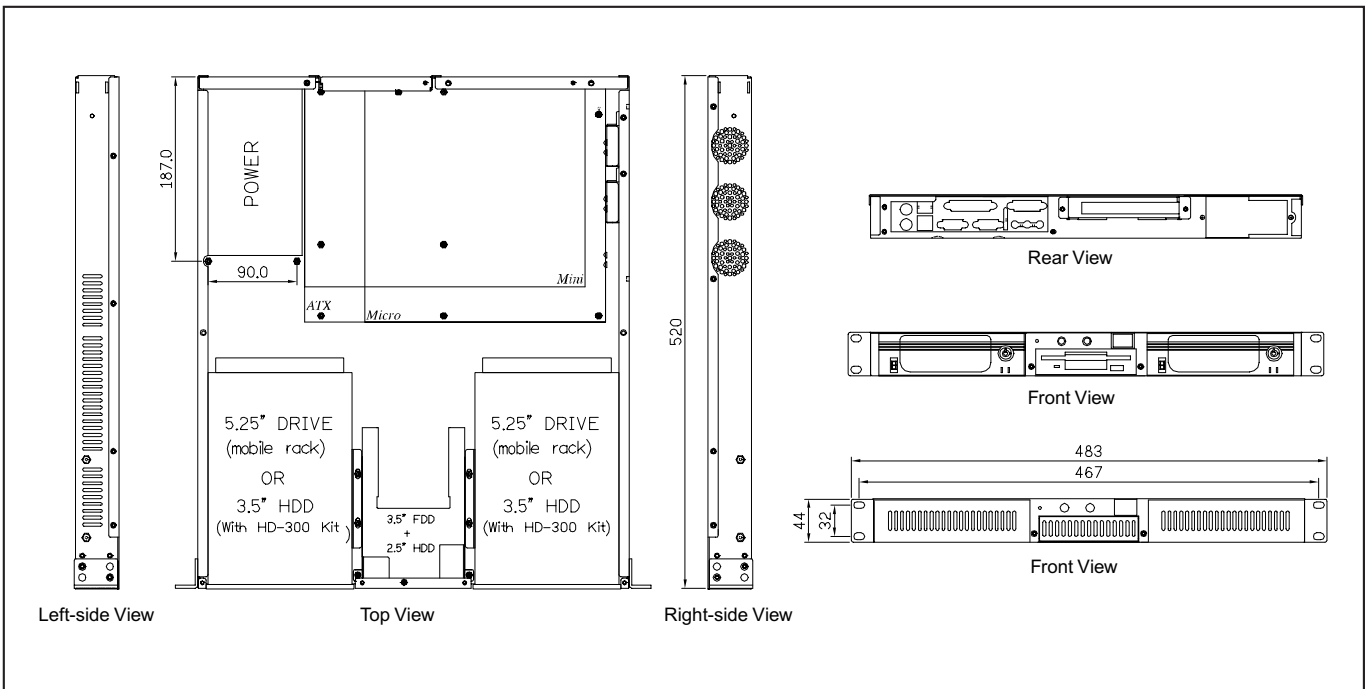

GHI-189

1 U Rackmount Chassis

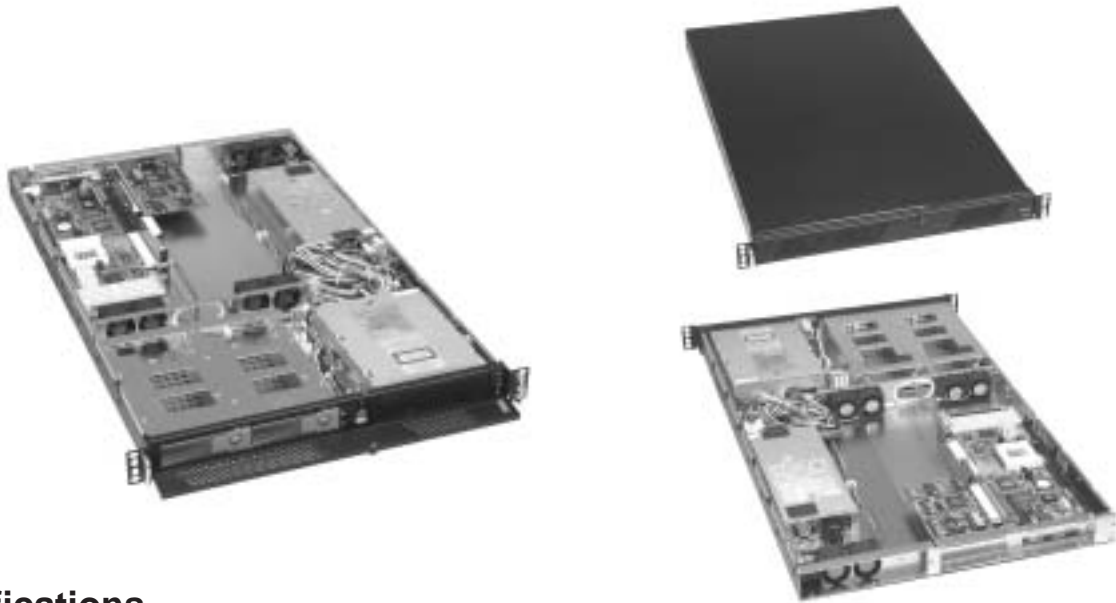

19" Rackmount

Specifications

- **EIA RS-310C 19" Rackmount Standard**
- **Construction:** Heavy Duty Cold Rolled Electroplated Steel
- **Color:** Black (Standard), Beige or Custom
- **Supports 4 Slot Passive Backplane**
- **Drive Capacity:** 1x 5.25" & 2x Hot Swap Drive Trays
- **Drive Interface:** PATA, SATA, SCSI320 or SAS
- **Power Supply (Optional):** 1U Single up to 500W ATX P/S (Mid Installation) Max. Depth 225mm
- **Cooling:** 6x (40x28mm = 15CFM ea.) Fans & 1x (40x20mm = 7CFM ea.) (Optional)
- **Connector Port (Front):** 2x USB Ports
- **Front Door:** Single Door with 1 Thumbscrew
- **Indicators:** LEDs for Power ON/OFF, HDD Activity, LAN
- **Switch:** Power ON/OFF Momentary (Square Pushbutton), System Reset
- **Dimensions (WxHxD):** 483x44x650mm(19" x 1.75" x 25.6")
- **Cuft:** 3.1
- **GW:** 14kgs / 30.8 lbs
- **Carton Size (cm):** 59.4 x 18.2 x 81.8 (23.4" x 7.2" x 32.2")
- **Humidity:** 5% - 95% Non-condensing

Dimension

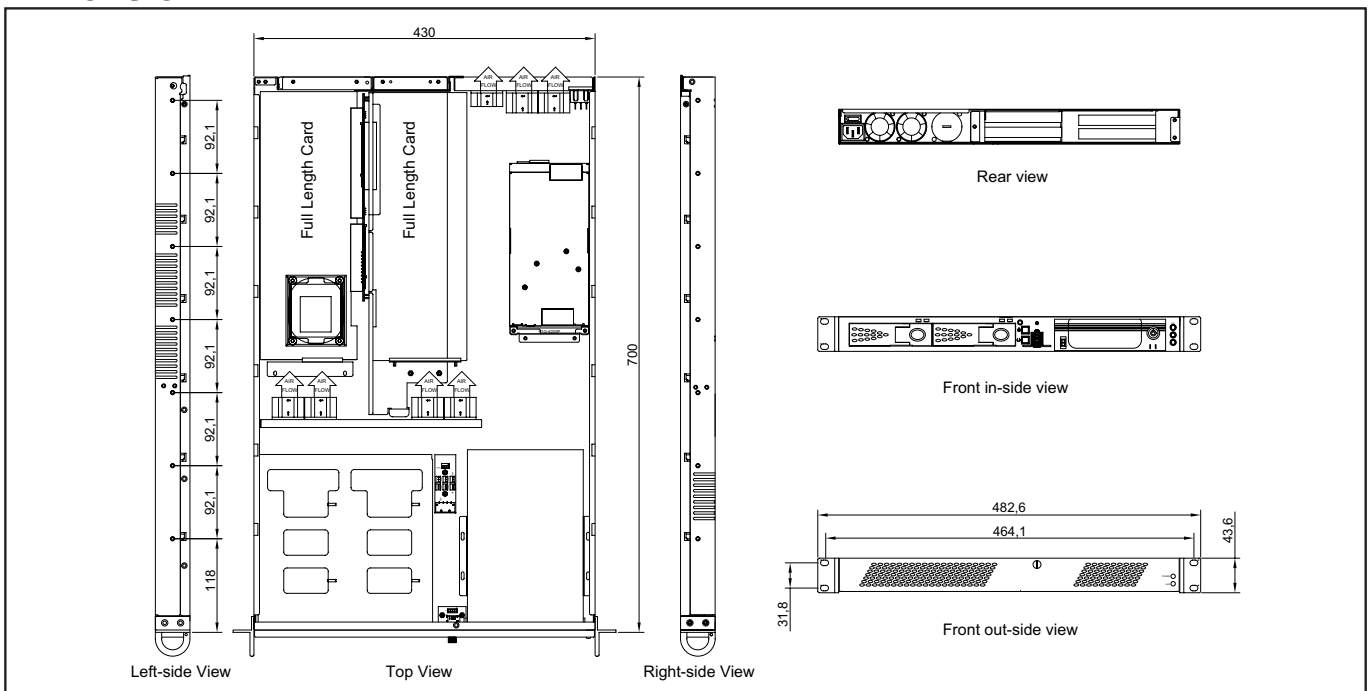

GHI-192

1 U Rackmount Chassis



Specifications

- **EIA RS-310C 19" Rackmount Standard**
- **Construction:** Heavy Duty Cold Rolled Electroplated Steel
- **Color:** Black (Standard), Beige or Custom
- **System Boards:** Dual Xeon, Dual Operton, Pentium 4, Dual Pentium III
- **Support EATX M/B (Max. to 12" x 10.6") SSI EEB 3.0**
- **Drive Capacity:** 1x 5.25" Slim CD-ROM & 2x 3.5"Swapple Tray & 1x 5.25" CD-ROM or GHA-FM05
- **Drive Interface:** PATA, SATA, SCSI320, Multilane SATA or SAS
- **Power Supply(Optional):** 1U Single up to 500W ATX P/S(Mid Installation) Max. Depth 225mm
- **Cooling:** 6x (40 x 20mm = 7CFM ea.) Fans
- **Connector Port(Front):** 2x USB Ports
- **Front Door:** Single Door With 1 Thumbscrew
- **Riser Card:** GHP-141 (32bit) or GHP-R0103 (64bit) (Optional)
- **Indicators:** LEDs for Power ON/OFF, HDD Activity
- **Switch:** Power ON/OFF, System Reset
- **Dimensions (W x H x D):** 483 x 44 x 560mm (19.0" x 1.7" x 22.1")
- **Cuft:** 2.1
- **GW:** 10.8kgs / 23.8lbs
- **Carton Size(cm):** 56.0 x 15.3 x 69.0 (22.1" x 6.0" x 27.2")
- **Humidity:** 5% - 95% Non-condensing

Dimension

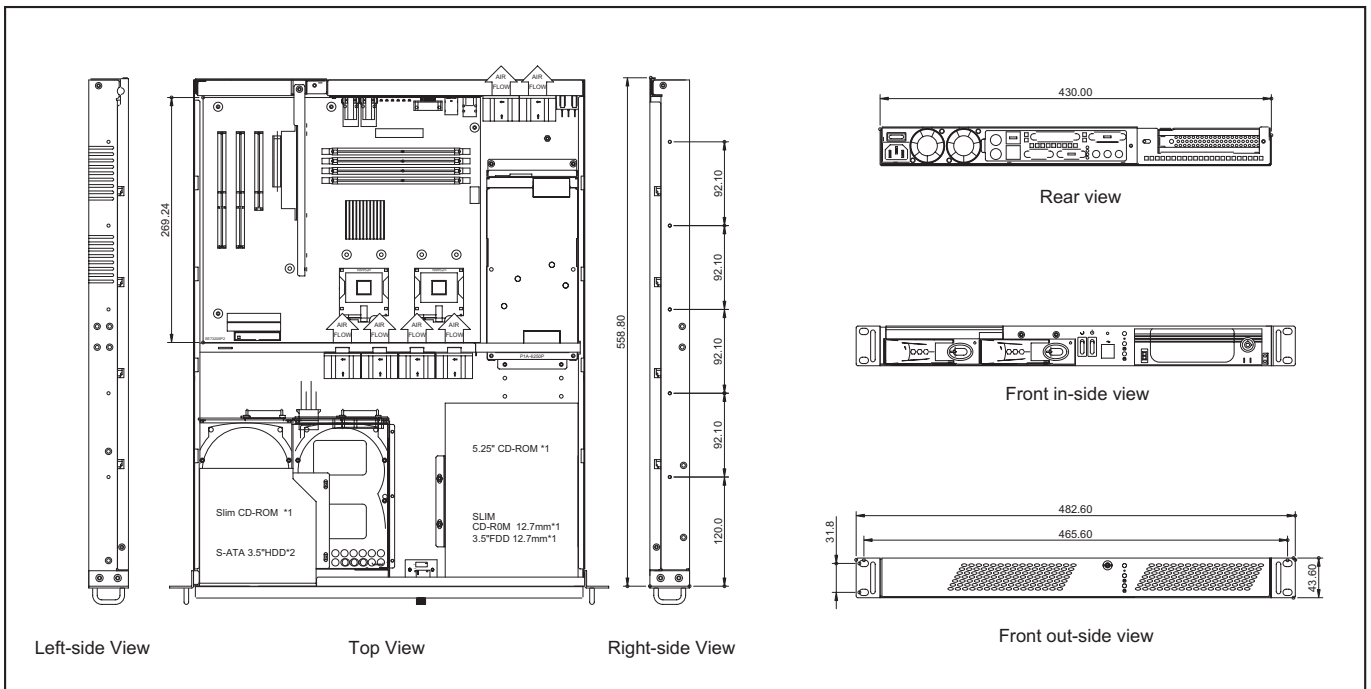

GH-198B/198L

1U Rackmount Chassis



Specifications

- **EIA RS-310C 19" Rackmount Standard**
- **Construction:** Heavy Duty Cold Rolled Electroplated Steel
- **Color:** Black (Standard), Beige or Custom
- **Support 2-Slot Passive Backplane (GH-198B)**
- **Support Little Board (GH-198L)**
- **Drive Capacity:** 1x 5.25" & 1x 3.5"FDD (or 1x Slim FDD, 1x 2.5" HDD) & 1x3.5"HDD
- **Power Supply (Optional):** 1U Single up to 300W ATX P/S(Rear Installation) Max. Depth 200mm
- **Cooling:** 2x (40 x 20mm = 7CFM ea.) Fans
- **Connector Port (Front):** 1xPS/2 Ports
- **Front Door:** Single Door with 2 Thumbscrews
- **Indicators:** LEDs for Power ON/OFF, HDD Activity
- **Switch:** Power ON/OFF Momentary (Square), System Reset
- **Dimensions (WxHxD):** 483x44x431mm (19" x 1.7" x 17.0")
- **Cuft:** 2.5
- **GW:** 8.0kgs / 17.6lbs
- **Carton Size(cm):** 62.7 x 18.1 x 61.3 (24.7" x 7.1" x 24.1")
- **Humidity:** 5% - 95% Non-condensing

Dimension

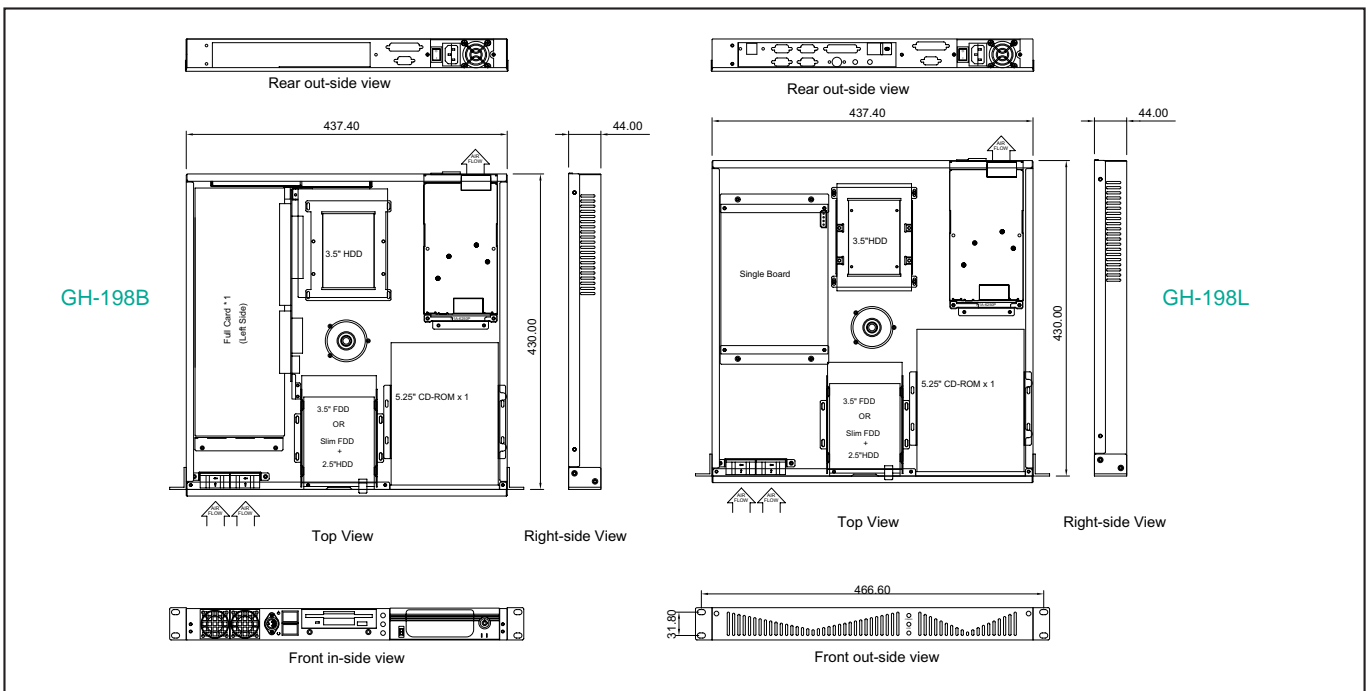

GHI-200

2U Rackmount Chassis

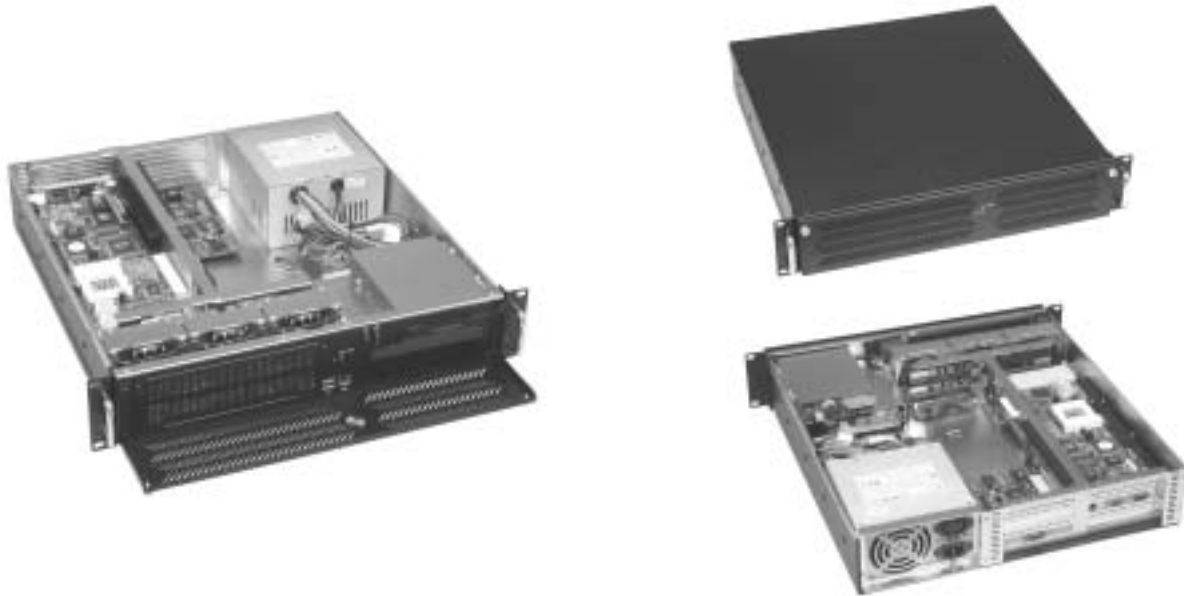

Specifications

- **EIA RS-310C 19" Rackmount Standard**
- **Construction:** Heavy Duty Cold Rolled Electroplated Steel
- **Color:** Black (Standard), Beige or Custom
- **Support 6-slot Passive Backplane**
- **Drive Capacity:** 1x 5.25" (or 1xSlim CD-ROM & 1x 3.5"HDD) & 1x 3.5"FDD
- **Power Supply(Optional):** PS/2 size single 400W or Redundant 250W (Rear Installation)
- **Cooling:** 3x (80 x 25mm = 42.5CFM ea.) Fans with Removable Air Filter
- **Front Door:** Single Door with 2 Thumbscrews
- **Air Filter:** Inside Front Panel (Washable)
- **Connector Port (Front):** 2x USB & 1x PS/2 Ports
- **Indicators:** LEDs for Power ON/OFF, HDD Activity
- **Switch:** Power ON/OFF Momentary(Rocker), System Reset
- **Dimensions (WxHxD):** 483x88x450mm(19"x3.5"x17.7")
- **Cuft:** 3.2
- **GW:** 13.0kgs / 28.7lbs
- **Carton Size(cm):** 63.0 x 24.8 x 57.4 (24.8" x 9.8" x 22.6")
- **Humidity:** 5% - 95% Non-condensing

Dimension

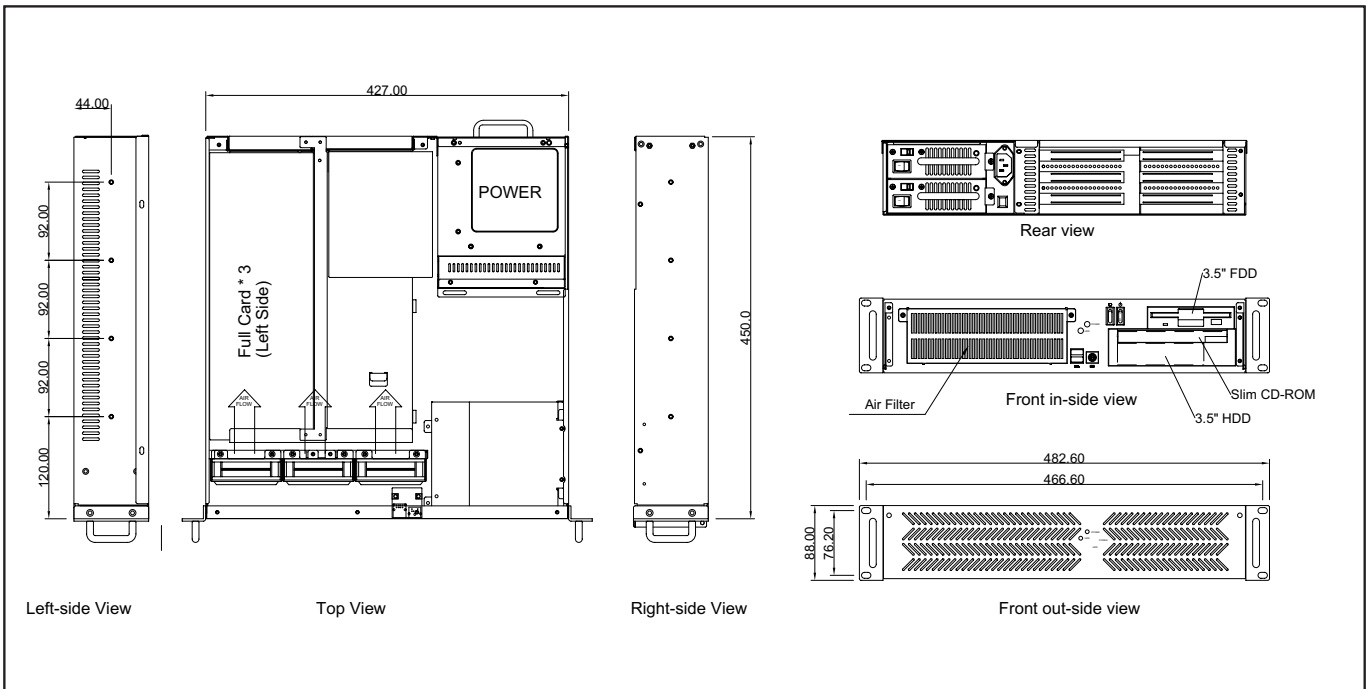

GHI-210

2U Rackmount Chassis



19" Rackmount

Specifications

- **EIA RS-310C 19" Rackmount Standard**
- **Construction:** Heavy Duty Cold Rolled Electroplated Steel
- **Color:** Black (Standard), Beige or Custom
- **System Boards:** Dual Xeon, Pentium 4, Dual Pentium III
- **Support ATX M/B (Max. to 12" x 9.6")**
- **Drive Capacity:** 1x 5.25"(or 1xSlim CD-ROM & 1x3.5"HDD) & 1x 3.5" & 3x 3.5" HDD
- **Power Supply (Optional):** 2U Single up to 400W or Redundant up to 350W ATX P/S (Rear Installation)
- **Cooling:** 3x (80mm = 42.5CFM ea.) Fans
- **Connector Port (Front):** 2x USB Ports
- **Front Door:** Single Door with 2 Thumbscrews
- **Air Filter:** Inside Front Panel (Washable)
- **Riser Card:** GHP-R0301 (32bit Ribbon) or GHP-R0304 (64bit Ribbon) (Optional)
- **Expansion Slots(Optional):** 2 or 3x Horizontal ISA/PCI/AGP Option Slots
- **Indicators:** LEDs for Power ON/OFF, HDD Activity
- **Switch:** Power ON/OFF Momentary (Square), System Reset
- **Dimensions (WxHxD):** 483x88x450mm (19" x 3.5" x 17.7")
- **Cuft:** 3.2
- **GW:** 14.0kgs / 30.9lbs
- **Carton Size(cm):** 63.0 x 24.8 x 57.4(24.8" x 9.8" x 22.6")
- **Humidity:** 5% - 95% Non-condensing

Dimension

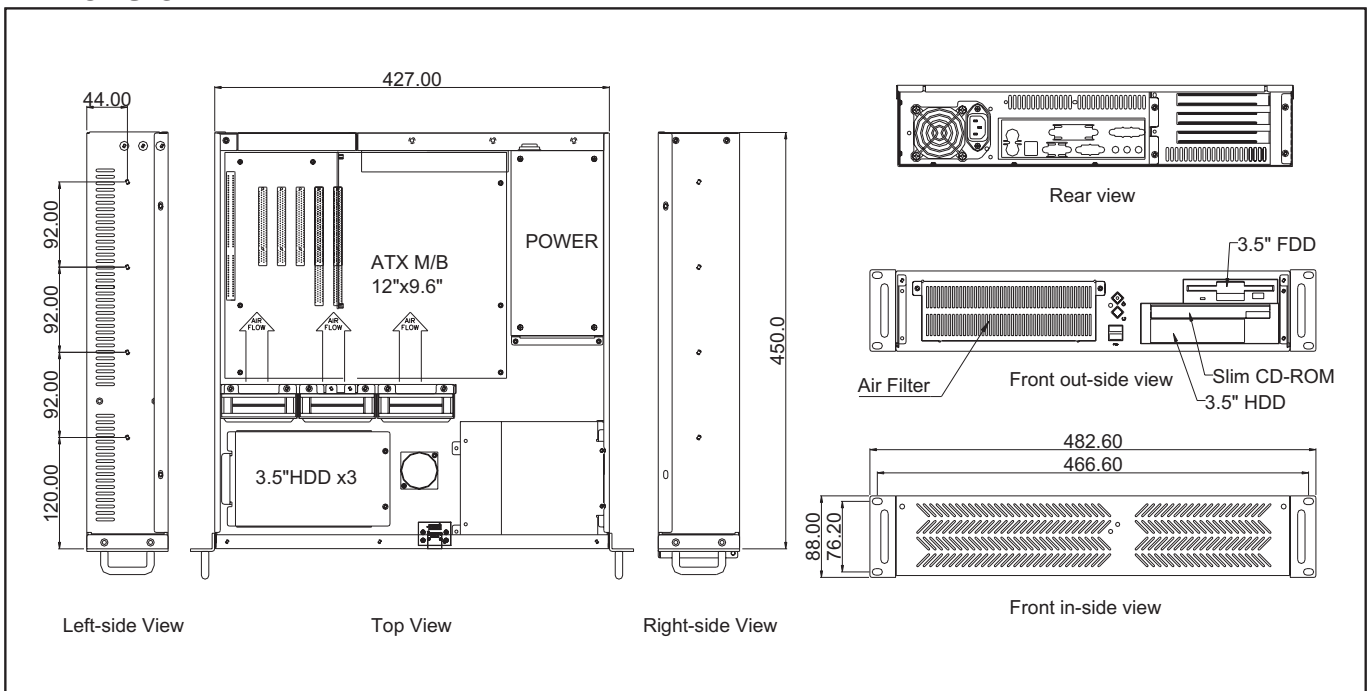

GH-212ATX

2U Rackmount Chassis

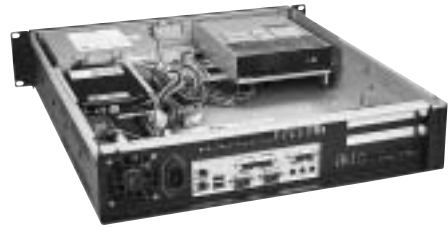

Specifications

- **EIA RS-310C 19" Rackmount Standard**
- **Construction:** Heavy Duty Cold Rolled Electroplated Steel
- **Color:** Black (Standard), Beige or Custom
- **System Boards:** Pentium 4
- **Support ATX M/B (Max. to 12" x 9.6")**
- **Drive Capacity:** 1x 5.25" & 1x 3.5" & 3x 3.5" HDD
- **Power Supply(Optional):** PS/2 Size Single up to 460W ATX P/S (Front/Mid Installation)
- **Cooling:** 1x (60mm = 23.5CFM ea.) & 1x (80mm = 42.5CFM ea.) Fan
- **Front Door:** Single Door with 1 Thumb Twist Keylock
- **Air Filter:** Inside Front Panel (Washable)
- **Riser Card:** GHP-R0301 (32bit Ribbon) or GHP-R0304 (64bit Ribbon) (Optional)
- **Expansion Slots (Optional):** 2 or 3x Horizontal ISA/PCI/AGP Option Slots
- **Indicators:** LEDs for Power ON/OFF, HDD Activity
- **Switch:** Power ON/OFF Momentary (Rocker), System Reset
- **Dimensions (WxHxD):** 483x88x501mm(19" x 3.5" x 19.7")
- **Cuft:** 3.6
- **GW:** 12.0kgs / 26.5lbs
- **Carton Size(cm):** 58.8 x 25.5 x 68.5 (23.1" x 10.0" x 27.0")
- **Humidity:** 5% - 95% Non-condensing

Dimension

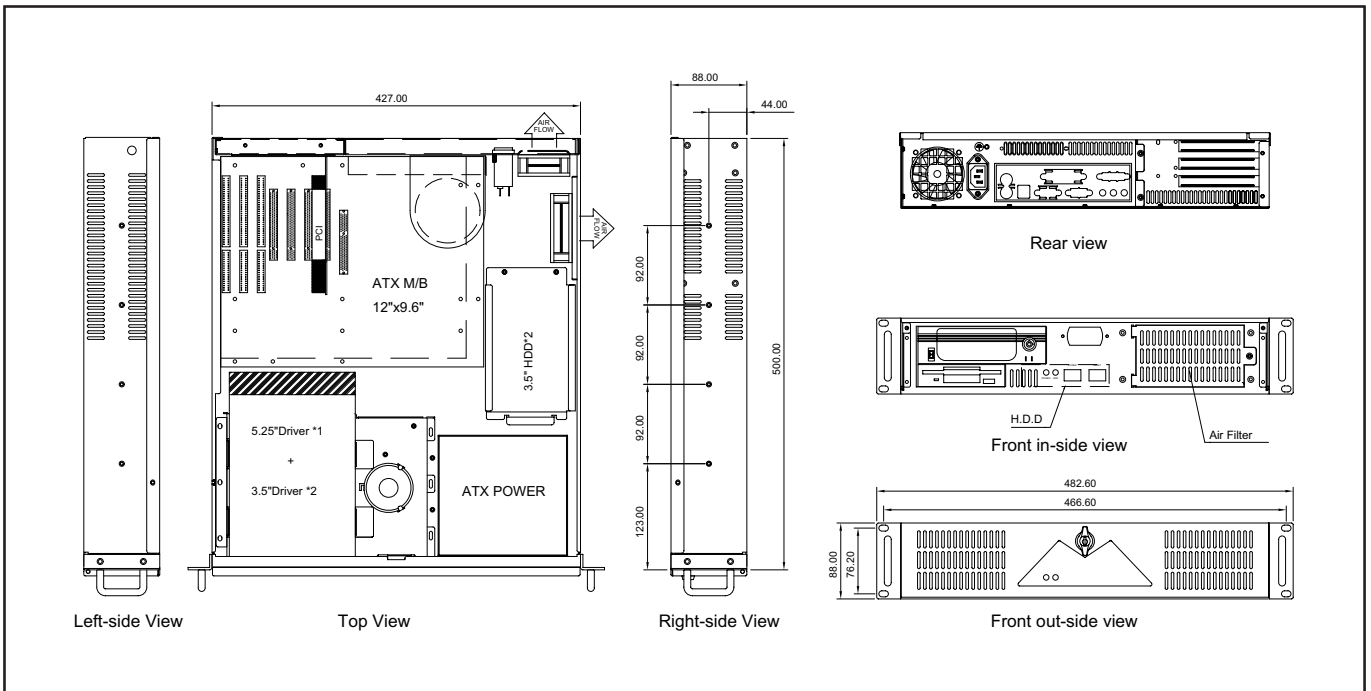

GHI-213

2U Rackmount Chassis



Specifications

- **EIA RS-310C 19" Rackmount Standard**
- **Construction:** Heavy Duty Cold Rolled Electroplated Steel
- **Color:** Black (Standard), Beige or Custom
- **System Boards:** Pentium 4, Athlon 64
- **Support ATX M/B (Max. to 12" x 9.6")**
- **Drive Capacity:** 1x 5.25" & 1x 3.5" & 3x 3.5"HDD
- **Power Supply (Optional):** 2U Single up to 400W or Redundant up to 350W ATX P/S (Rear Installation) Max. Depth 215mm
- **Cooling:** 3x (80 mm = 42.5CFM ea.) Fans
- **Front Door:** Single Door with 2 Thumbscrews
- **Air Filter:** Inside Front Panel (Washable)
- **Riser Card:** GHP-R0301 (32bit Ribbon) or GHP-R0304 (64bit Ribbon) (Optional)
- **Connector Port (Front):** 2x USB Ports
- **Expansion Slots(Optional):** 2 or 3x Horizontal ISA/PCI/AGP Option Slots
- **Indicators:** LEDs for Power ON/OFF, HDD Activity
- **Switch:** Power ON/OFF, System Reset
- **Dimensions (WxHxD):** 483x88x450mm (19" x 3.5" x 17.7")
- **Cuft:** 3.2
- **GW:** 14.0kgs / 30.9lbs
- **Carton Size(cm):** 63.0 x 24.8 x 57.4 (24.8" x 9.8" x 22.6")
- **Humidity:** 5% - 95% Non-condensing

Dimension

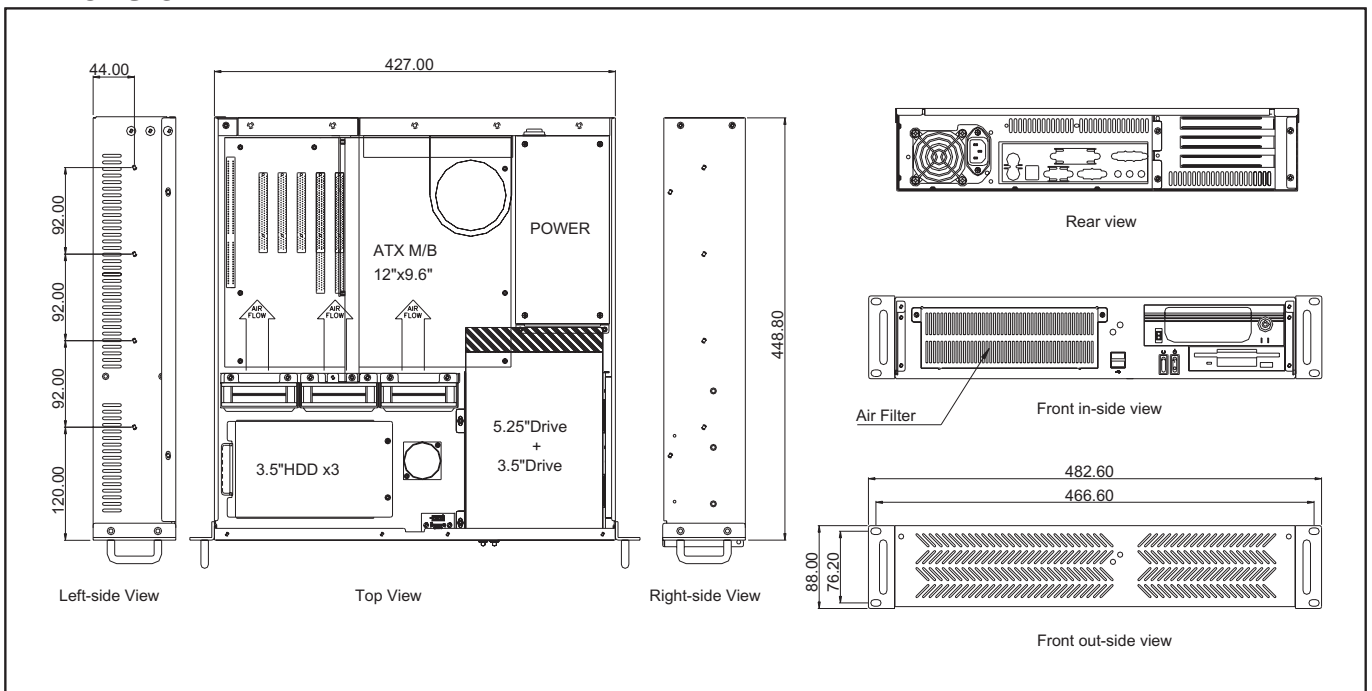

GHI-214

2U Rackmount Chassis



Specifications

- **EIA RS-310C 19" Rackmount Standard**
- **Construction:** Heavy Duty Cold Rolled Electroplated Steel
- **Color:** Black (Standard), Beige or Custom
- **System Boards:** Pentium 4, Athlon 64, Dual Xeon, Dual Opteron
- **Support ATX M/B (Max. to 12" x 13")**
- **Drive Capacity:** 1x 5.25" & 1x 3.5" & 5.25" Slim CD-ROM & 3x 3.5"HDD
- **Power Supply (Optional):** 2U Single up to 510W or Redundant up to 400W ATX PSU (Rear Installation) Max. Depth 300mm
- **Cooling:** 3 x (80mm=42.5CFM ea.) Fans
- **Connector Port (Front):** 2x USB Ports
- **Front Door:** Single Door With 2 Thumbscrews
- **Air Filter:** Inside Front Panel (Washable)
- **Riser Card:** GHP-R0301 (32bit Ribbon) or GHP-R0304 (64bit Ribbon) (Optional)
- **Expansion Slots(Optional):** 2 or 3x Horizontal ISA/PCI/AGP Option Slots
- **Indicators:** LEDs for Power ON/OFF, HDD Activity
- **Switch:** Power ON/OFF, System Reset
- **Dimensions (W x H x D):** 483 x 88 x 510mm (19" x 3.5" x 20.1")
- **Cuft:** 3.5
- **GW:** 10.3 kgs / 22.7 lbs
- **Carton Size(cm):** 59.0 x 24.5 x 69.3 (23.2" x 9.7" x 27.3")
- **Humidity:** 5% - 95% Non-condensing

Dimension

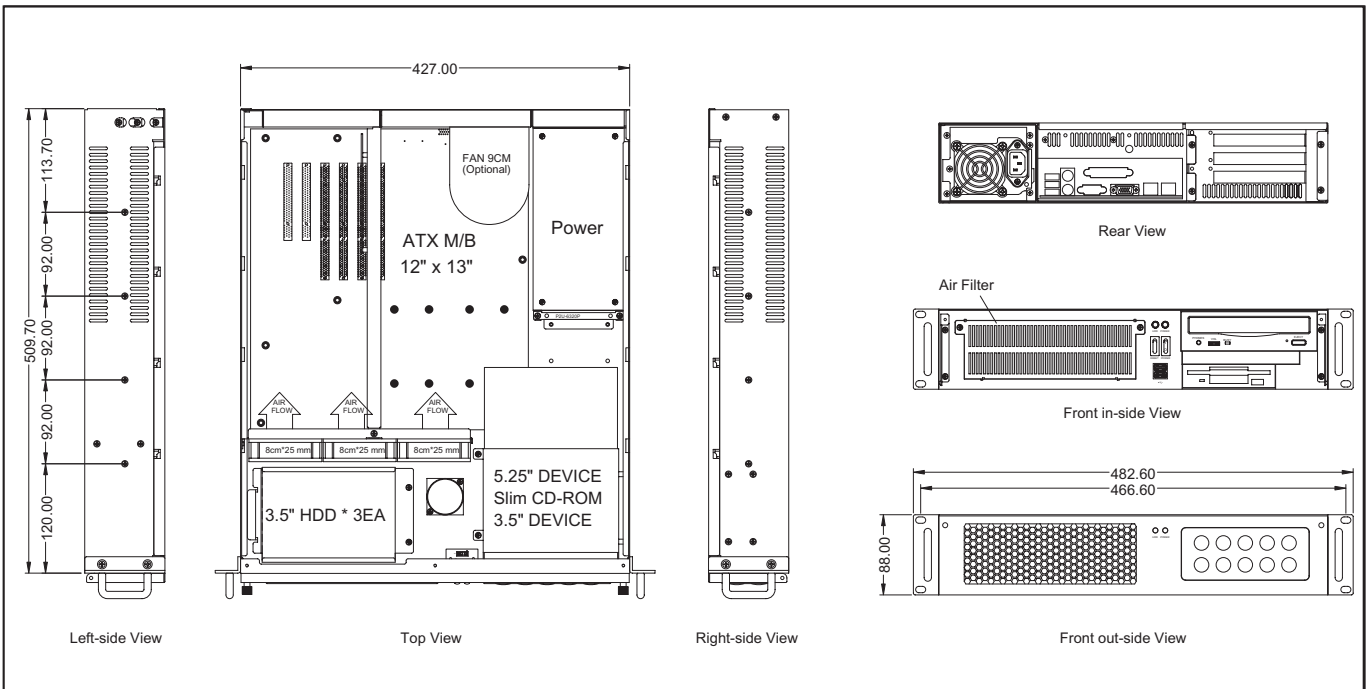

GHI-220

2U Rackmount Chassis

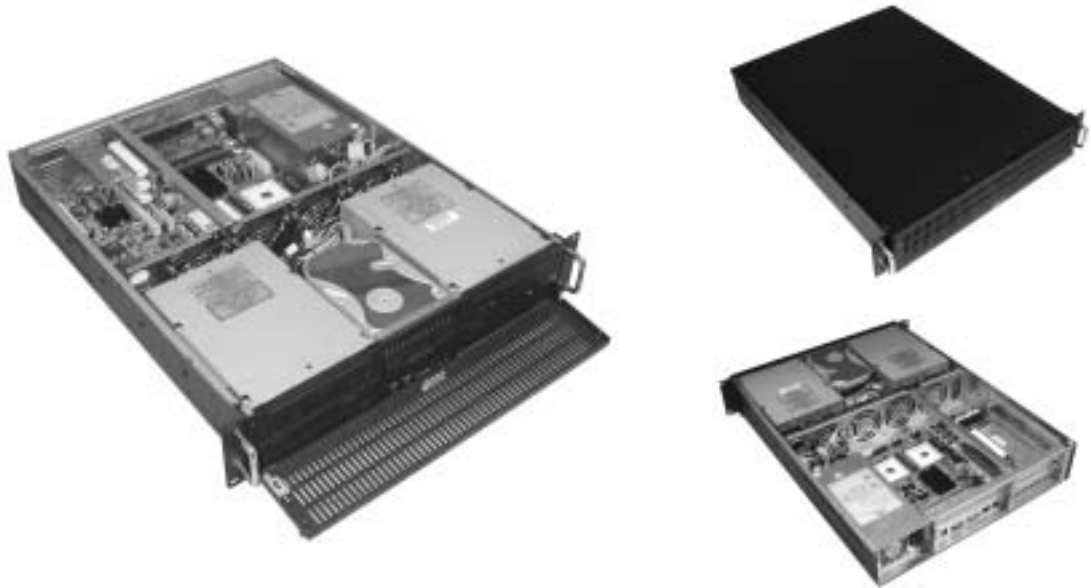

19" Rackmount

Specifications

- **EIA RS-310C 19" Rackmount Standard**
- **Construction:** Heavy Duty Cold Rolled Electroplated Steel
- **Color:** Black (Standard), Beige or Custom
- **System Boards:** Pentium 4, Dual Xeon, Athlon 64, Dual Opteron
- **Support EATX M/B (Max. to 12" x 10.5")**
- **Drive Capacity:** 4x 5.25" & 2x 3.5"HDD & 1x 3.5"FDD or 6 Storage Module (DE75i) & 2x 3.5"HDD & 1x 3.5"FDD
- **Power Supply (Optional):** 2U Single up to 510W or Redundant up to 400W ATX P/S (Rear Installation) Max. Depth 265mm
- **Cooling:** 4x (80mm = 42.5CFM ea.)
- **Front Door:** Single Door With 2 Thumbscrew and Removeable Door
- **Connector Port (Front):** 2 x USB Ports
- **Indicators:** LEDs for Power ON/OFF, HDD Activity , 2x LAN
- **Switch:** Power ON/OFF Momentary (Dimple), System Reset
- **Dimensions (W x H x D):** 483 x 88 x 570mm (19" x 3.5" x 22.4")
- **Cuft:** 2.9
- **GW:** 12.7kgs / 28lbs
- **Carton Size(cm):** 56.2 x 20.3 x 71.3 (22.1" x 8.0" x 28.1")
- **Humidity:** 5% - 95% Non-condensing

Dimension

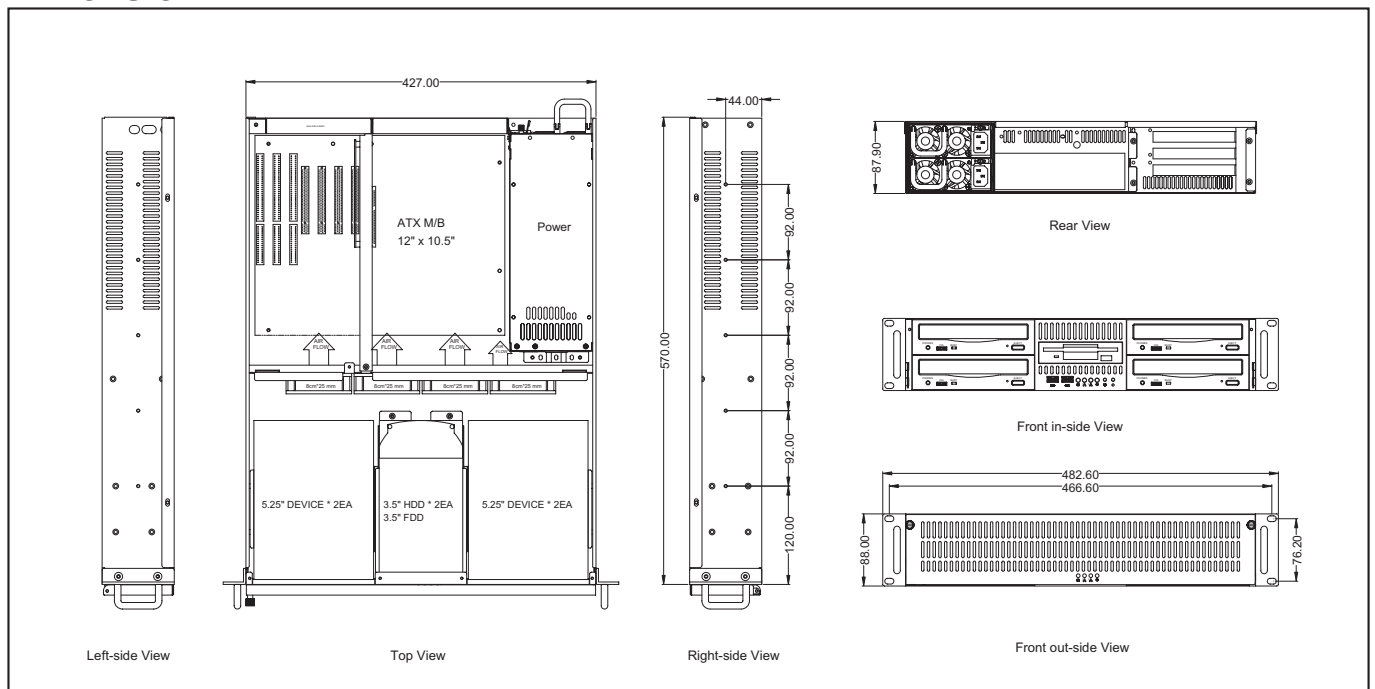

GHI-221

2U Rackmount Chassis



Specifications

- **EIA RS-310C 19" Rackmount Standard**
- **Construction:** Heavy Duty Cold Rolled Electroplated Steel
- **Color:** Black (Standard), Beige or Custom
- **System Boards:** Pentium 4, Dual Xeon, Athlon 64, Dual Opteron
- **Support EATX M/B (Max. to 12" x 13") SSI EEB3.0**
- **Drive Capacity:** 4x 5.25" & 2x 3.5"HDD & 1x 3.5"FDD or 6 Storage Module (DE75i) & 2x 3.5"HDD & 1x 3.5"FDD
- **Power Supply (Optional):** 2U Single up to 510W or Redundant up to 400W ATX P/S (Rear Installation) Max. Depth 300mm
- **Cooling:** 4x (80mm = 42.5CFM ea.)
- **Front Door:** Single Door With 2 Thumbscrew and Removeable Door
- **Connector Port (Front):** 2 x USB Ports
- **Indicators:** LEDs for Power ON/OFF, HDD Activity , 2x LAN
- **Switch:** Power ON/OFF Momentary (Dimple), System Reset
- **Dimensions (W x H x D):** 483 x 88 x 650mm (19" x 3.5" x 25.6")
- **Cuft:** 4.4
- **GW:** 13.8kgs /30.4lbs
- **Carton Size(cm):** 58.8 x 25.5 x 82.5 (23.2" x 10" x 32.5")
- **Humidity:** 5% - 95% Non-condensing

Dimension

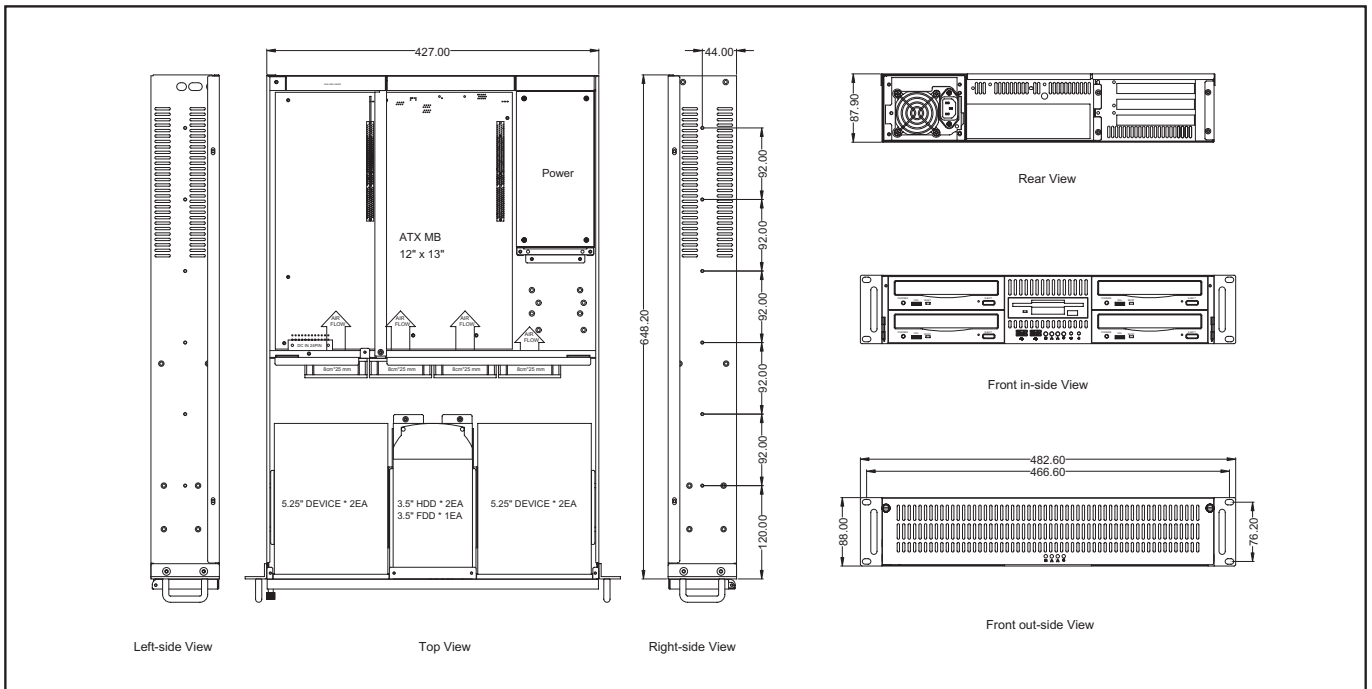

GH-231ATX

2U Rackmount Chassis

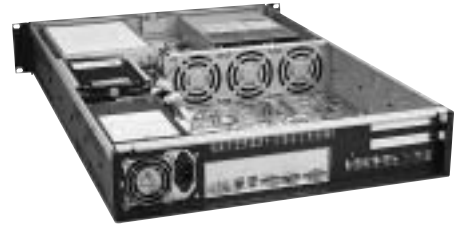

19" Rackmount

Specifications

- **EIA RS-310C 19" Rackmount Standard**
- **Construction:** Heavy Duty Cold Rolled Electroplated Steel
- **Color:** Black (Standard), Beige or Custom
- **System Boards:** Pentium 4, Athlon 64, Opteron
- **Support EATX M/B (Max. to 12" x 13")**
- **Drive Capacity:** 2x 5.25" & 2x 3.5" & 3x 3.5" HDD
- **Power Supply (Optional):** 2U Single up to 400W or Redundant up to 350W ATX P/S (Rear Installation) Max. Depth 300mm
- **Cooling:** 3x (80mm = 42.5CFM ea.) Fans
- **Front Door:** Single Door with 1 Thumb Twist Keylock
- **Riser Card:** GHP-R0301 (32bit Ribbon) or GHP-R0304 (64bit Ribbon) (Optional)
- **Expansion Slots(Optional):** 2 or 3x Horizontal ISA/PCI/AGP Option Slots
- **Indicators:** LEDs for Power ON/OFF, HDD Activity
- **Switch:** Power ON/OFF Momentary (Rocker), System Reset
- **Dimensions (WxHxD):** 483x88x650mm (19" x 3.5" x 25.6")
- **Cuft:** 4.4
- **GW:** 15kgs / 33.1lbs
- **Carton Size(cm):** 58.8 x 25.5 x 82.5(23.1" x 10.0" x 32.5")
- **Humidity:** 5% - 95% Non-condensing

Dimension

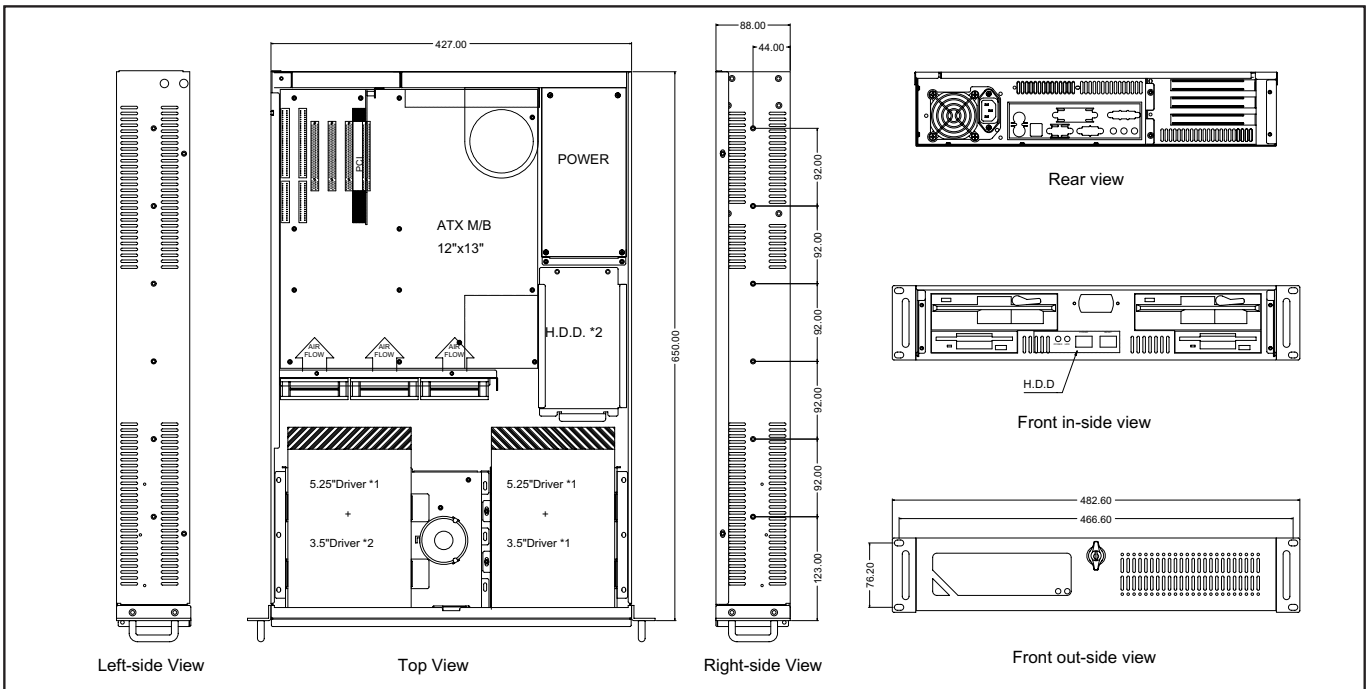

GH-232ATX

2U Rackmount Chassis



Specifications

- **EIA RS-310C 19" Rackmount Standard**
- **Construction:** Heavy Duty Cold Rolled Electroplated Steel
- **Color:** Black (Standard), Beige or Custom
- **System Boards:** Pentium 4, Dual Xeon, Athlon 64, Dual Opteron
- **Support EATX M/B (Max. to 12" x 13")**
- **Drive Capacity:** 1x 5.25" & 1x 3.5" & 5x 3.5" HDD
- **Power Supply (Optional):** PS/2 Size Single up to 460W ATX P/S (Front/Mid Installation) Max. Depth 300mm
- **Cooling:** 1x (60mm = 23.5CFM ea.) & 3x (80mm = 42.5CFM ea.) Fans
- **Air Filter:** Inside Front Panel (Washable)
- **Front Door:** Single Door with 1 Thumb Twist Keylock
- **Riser Card:** GHP-R0301 (32bit Ribbon) or GHP-R0304 (64bit Ribbon) (Optional)
- **Expansion Slots(Optional):** 2 or 3x Horizontal ISA/PCI/AGP Option Slots or 7x Low Profile PCI Slots
- **Indicators:** LEDs for Power ON/OFF, HDD Activity
- **Switch:** Power ON/OFF Momentary(Rocker), System Reset
- **Dimensions (WxHxD):** 483x88x650mm (19" x 3.5" x 25.6")
- **Cuft:** 4.4
- **GW:** 15kgs / 33.1lbs
- **Carton Size(cm):** 58.8 x 25.5 x 82.5 (23.1" x 10" x 32.5")
- **Humidity:** 5% - 95% Non-condensing

Dimension

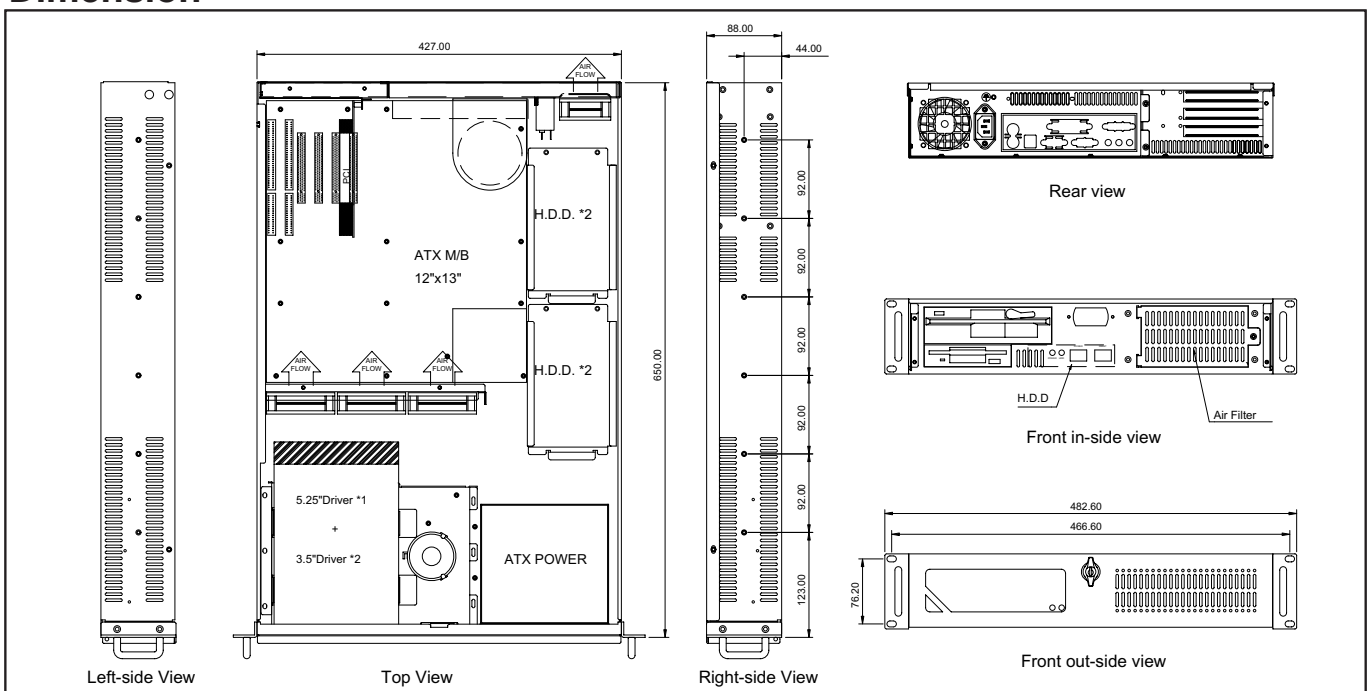

GHI-240

2U Rackmount Chassis



Specifications

- **EIA RS-310C 19" Rackmount Standard**
- **Construction:** Heavy Duty Cold Rolled Electroplated Steel
- **Color:** Black (Standard), Beige or Custom
- **System Boards:** Pentium 4, Dual Xeon, Athlon 64, Dual Opteron
- **Support EATX M/B (Max. to 16" x 13") SSI EEB 3.0**
- **Drive Capacity:** 1x Slim CD-ROM & 4x 3.5" Swappable Tray
- **Drive Interface:** PATA, SATA, SCSI320 or SAS
- **Power Supply (Optional):** 2U Redundant up to 750W (Front Installation)
- **Cooling:** 4x (80mm = 42.5CFM ea.) & 2x (40x28mm = 15.3CFM ea.) Fans
- **Riser Card:** GHP-R0301 (32bit Ribbon) or GHP-R0304 (64bit Ribbon) (Optional)
- **Connector Port (Front):** 2x USB Ports
- **Thermal Management Card:** GHA-CO04
- **Indicators:** LEDs for Power ON/OFF, HDD Activity, Fan, Temperature
- **Switch:** Power ON/OFF Momentary (Pushbutton), System Reset, Buzzer Reset
- **Dimensions (W x H x D):** 483 x 88 x 710mm (19" x 3.5" x 28.0")
- **Cuft:** 4.4
- **GW:** 16.3 kgs / 36.0 lbs
- **Carton Size(cm):** 57.0 x 24.0 x 90.5 (22.4" x 9.5" x 35.6")
- **Humidity:** 5% - 95% Non-condensing

Dimension

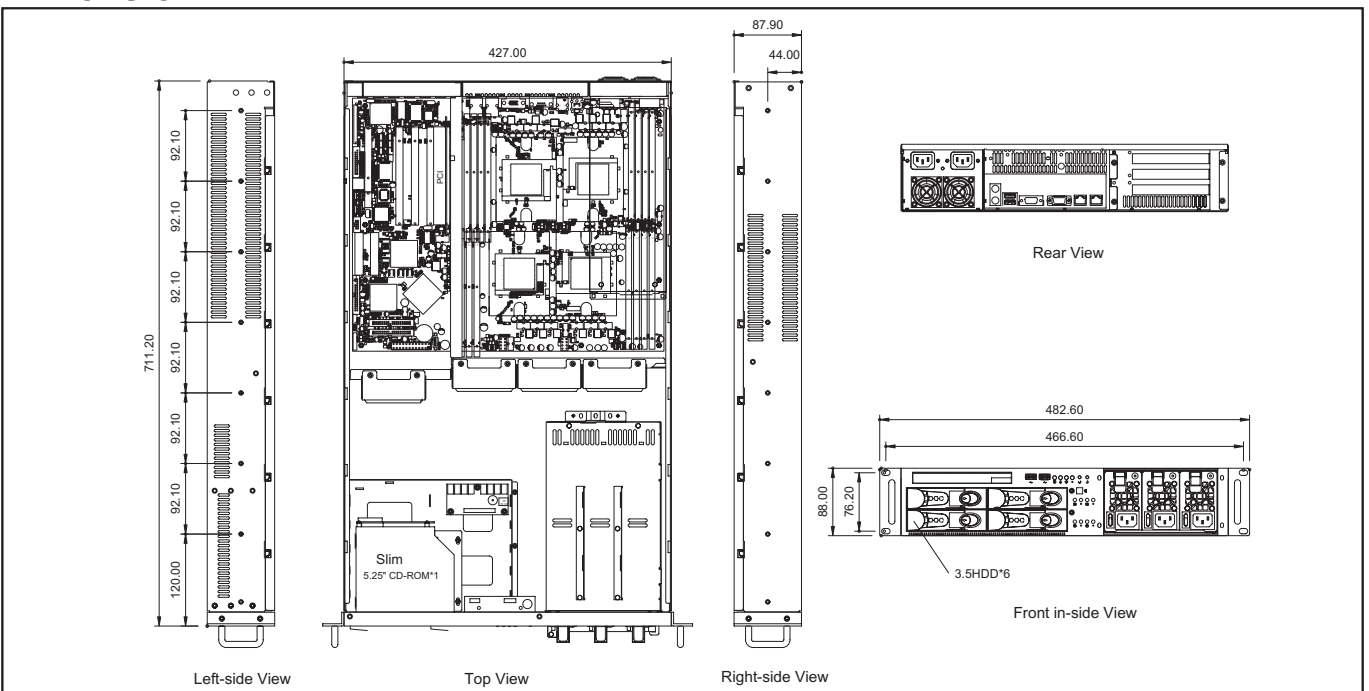

GHI-246

2U Rackmount Chassis

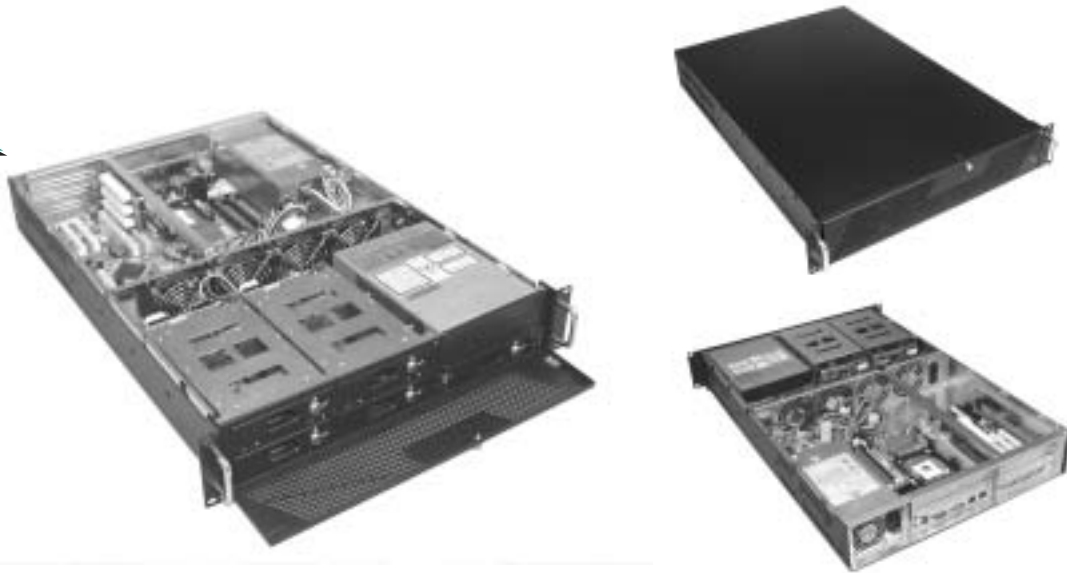

19" Rackmount

Specifications

- **EIA RS-310C 19" Rackmount Standard**
- **Construction:** Heavy Duty Cold Rolled Electroplated Steel
- **Color:** Black (Standard), Beige or Custom
- **System Boards:** Dual Xeon, Pentium 4, Dual Pentium III
- **Support EATX M/B(Max. to 12"x13")**
- **Drive Capacity:** 1x5.25" CD-ROM & 5x3.5" Swappable Drive Trays
- **Drive Interface:** P-ATA ,SCSI , S-ATA, SAS (Optional)
- **Power Supply(Optional):** 2U Single up to 600W or 2U Redundant up to 500W ATX P/S (Rear Installation)
- **Max. Depth 300mm**
- **Cooling:** 4x(8cm) Fans(42.5CFM ea.)

- **Front Door:** Single Door With One Thumbscrew (Removable)
- **Connector Port (Front):** 1x USB Port
- **Expansion Slots(Optional):** 2 or 3xHorizontal Slots(ISA, PCI, AGP Option) or 7x Low Profile PCI Slots
- **Indicators:** LEDs for Power ON/OFF, HDD Power/Access, LAN
- **Switch:** Power ON/OFF, System Reset
- **Dimensions (W x H x D):** 483 x 88 x 650mm (19"x3.5"x25.6")
- **Cuft:** 4.4
- **GW:** 15.5 kgs / 34.2 lbs
- **Carton Size(cm):** 58.8 x 25.5 x 82.5(23.1" x 10.0" x 32.5")
- **Humidity:** 5% - 95% Non-condensing

Dimension

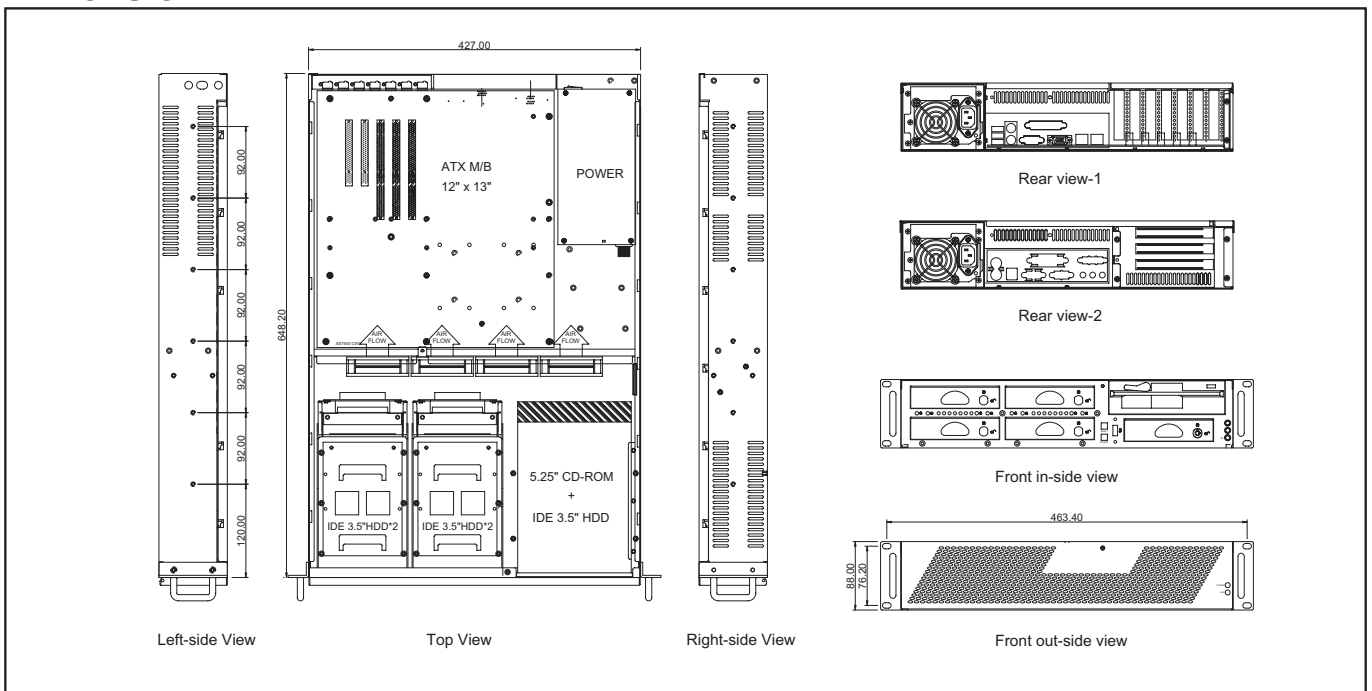

GHI-250

2U Rackmount Chassis

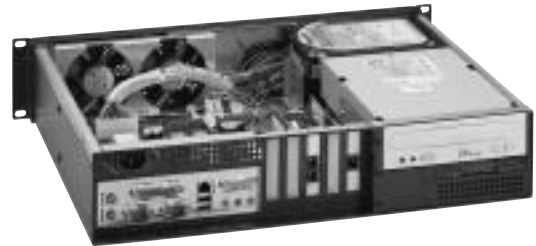

Specifications

- **EIA RS-310C 19" Rackmount Standard**
- **Construction:** Heavy Duty Cold Rolled Electroplated Steel
- **Color:** Black (Standard), Beige or Custom
- **System Boards:** Pentium 4, Athlon 64
- **Support ATX M/B (Max. to 12" x 9.6")**
- **Drive Capacity:** 1x 5.25" & 1x Slim 3.5" FDD & 1x 3.5" HDD
- **Power Supply (Optional):** 1U Single up to 300W ATX P/S(Mid Installation) Max. Depth 205mm
- **Cooling:** 2x (80mm = 42.5CFM ea.) Fans
- **Expansion Slots:** 5x Low Profile PCI Slots
- **Indicators:** LEDs for Power ON/OFF, LAN, HDD Activity
- **Switch:** Power ON/OFF Momentary (Square), System Reset
- **Dimensions (WxHxD):** 483x88x355mm (19" x 3.5" x 13.9")
- **Cuft:** 2.0
- **GW:** 9.0kgs / 19.8lbs
- **Carton Size(cm):** 57.0 x 20.3 x 50.0 (22.4" x 8.0" x 19.7")
- **Humidity:** 5% - 95% Non-condensing

Dimension

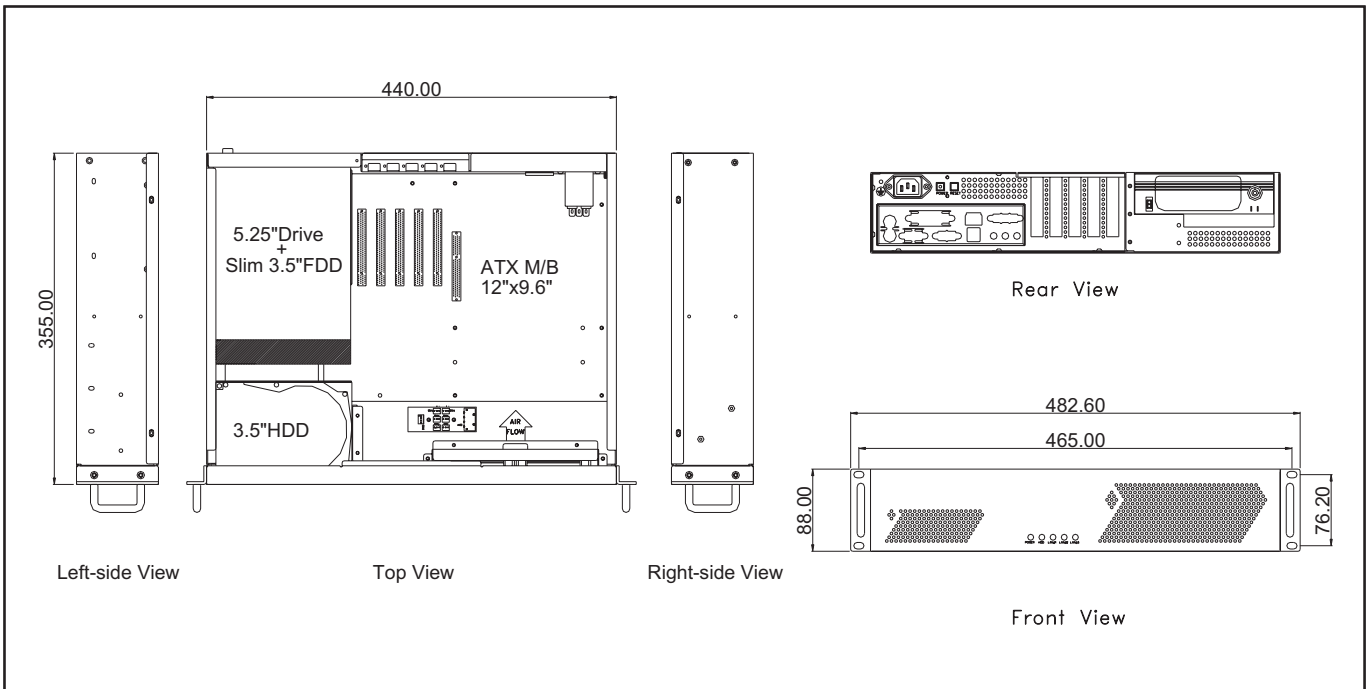

GHI-251

2U Rackmount Chassis



Specifications

- **EIA RS-310C 19" Rackmount Standard**
- **Construction:** Heavy Duty Cold Rolled Electroplated Steel
- **Color:** Black (Standard), Beige or Custom
- **System Boards:** Pentium 4, Athlon 64
- **Support ATX M/B (Max. to 12" x 9.6")**
- **Drive Capacity:** 1x 5.25" & 2x 3.5" HDD
- **Power Supply (Optional):** 1U Single up to 300W ATX P/S(Rear Installation) Max. Depth 205mm
- **Cooling:** 2x (80mm = 42.5CFM ea.) & 2x (40 x 28mm = 15CFM ea.)(Optional) Fans
- **Connector Port (Front):** 2x USB Ports
- **Expansion Slots:** 7x Low Profile PCI Slots
- **Indicators:** LEDs for Power ON/OFF, LAN, HDD Activity
- **Switch:** Power ON/OFF Momentary (Square), System Reset
- **Dimensions (WxHxD):** 483x88x355mm (19" x 3.5" x 13.9")
- **Cuft:** 2.0
- **GW:** 9.0kgs / 19.8lbs
- **Carton Size(cm):** 57.0 x 20.3 x 50.0 (22.4" x 8.0" x 19.7")
- **Humidity:** 5% - 95% Non-condensing

Dimension

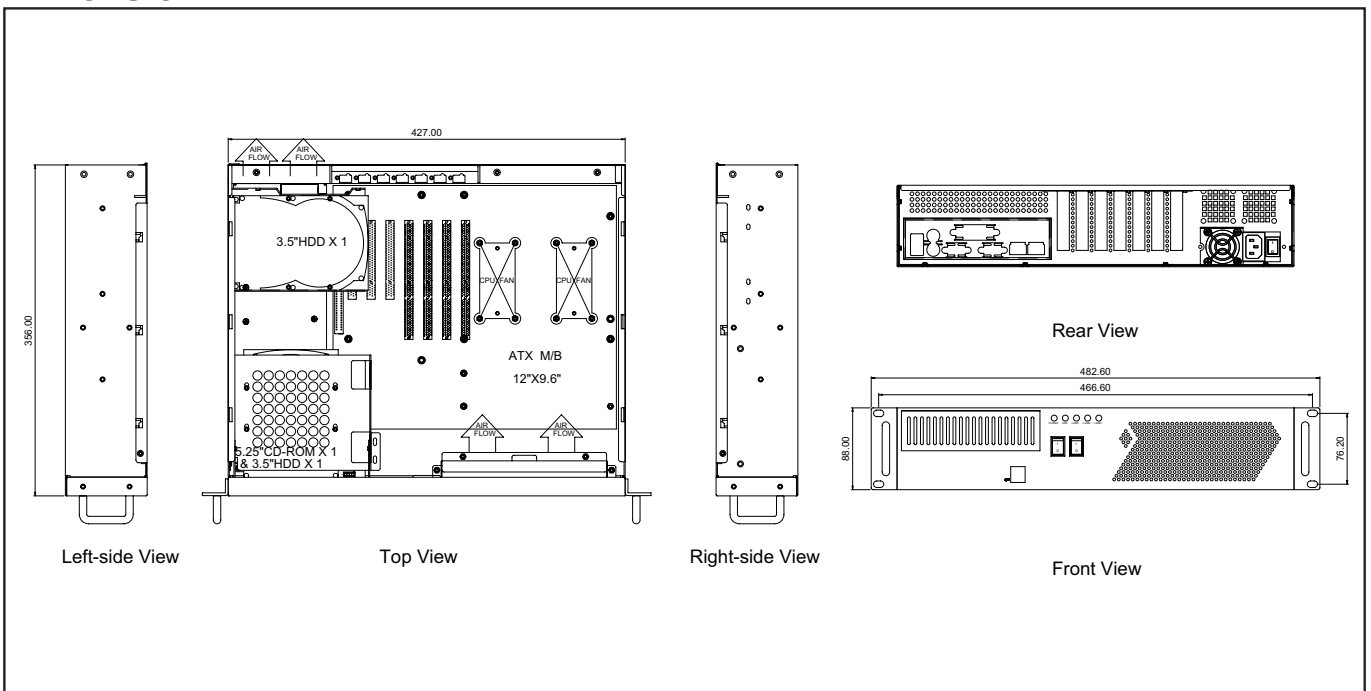

GHI-252V/252H

2U Rackmount Chassis



Specifications

- **EIA RS-310C 19" Rackmount Standard**
- **Construction:** Heavy Duty Cold Rolled Electroplated Steel
- **Color:** Black (Standard), Beige or Custom
- **System Boards:** Pentium 4, Athlon 64
- **Support ATX M/B (Max. to 12" x 9.6")**
- **Drive Capacity:** 1x 5.25" & 1x Slim FDD & 3x 3.5" HDD
- **Power Supply (Optional):** 1U Single up to 300W ATX P/S (Rear Installation) Max. Depth 205mm
- **Cooling:** 1x (80mm = 42.5CFM ea.) & 2x (40 x 20mm = 7CFM ea) Fans
- **Riser Card:** GHP-R0301 (32bit Ribbon) or GHP-R0304 (64bit Ribbon) (Optional)
- **Connector Port (Front):** 2x USB Ports
- **Expansion Slots(Optional):** 2 or 3x Horizontal ISA/PCI/AGP Option Slots(GHI-252H) or 7x Low Profile PCI Slots (GHI-252V)
- **Indicators:** LEDs for Power ON/OFF, LAN, HDD Activity
- **Switch:** Power ON/OFF Momentary(Square), System Reset
- **Dimensions (WxHxD):** 483x88x355mm (19" x 3.5" x 13.9")
- **Cuft:** 2.0
- **GW:** 9.0kgs / 19.8lbs
- **Carton Size(cm):** 57.0 x 20.3 x 50.0 (22.4" x 8.0" x 19.7")
- **Humidity:** 5% - 95% Non-condensing

Dimension

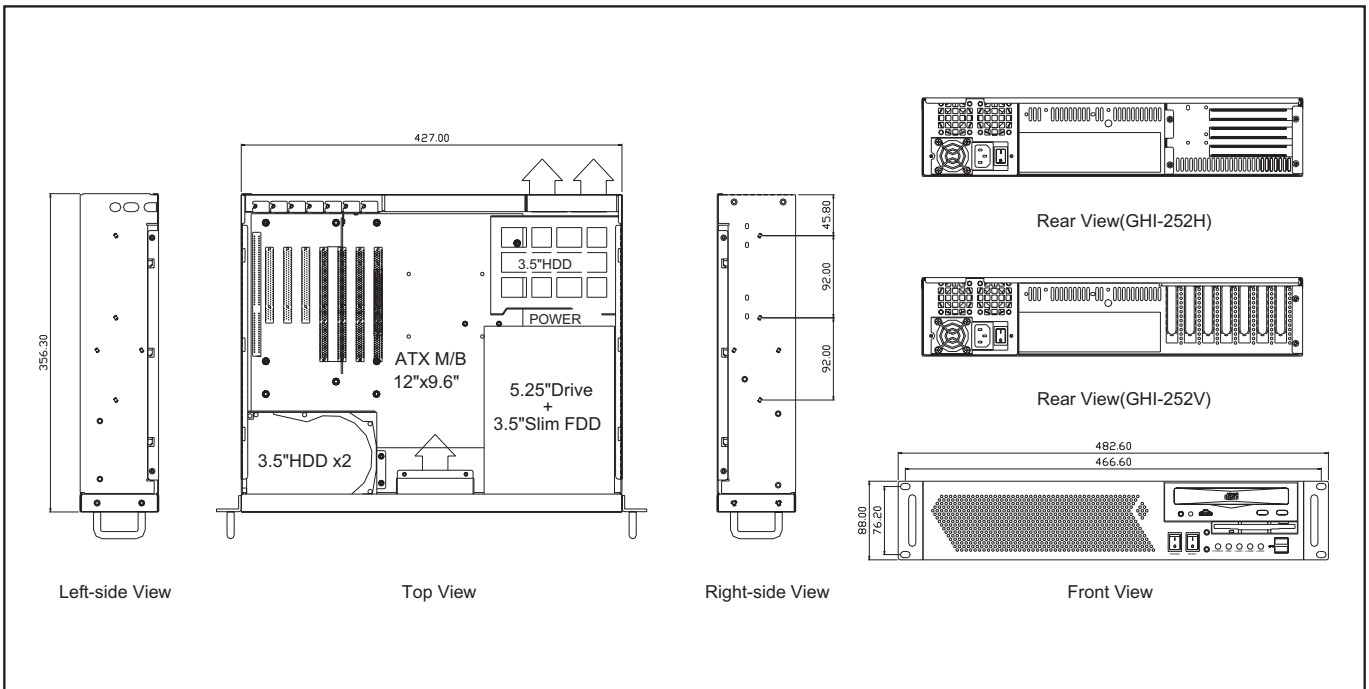

GHI-260

2U Rackmount Chassis



19" Rackmount

Specifications

- **EIA RS-310C 19" Rackmount Standard**
- **Construction:** Heavy Duty Cold Rolled Electroplated Steel
- **Color:** Black (Standard), Beige or Custom
- **System Boards:** Pentium 4, Dual Xeon, Athlon 64, Dual Opteron
- **Support EATX M/B (Max. to 12" x 13") SSI EEB 3.0**
- **Drive Capacity:** 16x Hot Swap 2.5" Drive Tray & 1x 5.25" CD-ROM
- **Drive Interface:** SATAII, SCSI320 or SAS
- **Power Supply :** 2U Single up to 600W or Redundant up to 500W ATX P/S (Rear Installation) Max. Depth 300mm
- **Cooling:** 4x (80mm = 42.5CFM ea.) Fans
- **Front Door:** Single Door With 2 Thumbscrews (Removable)
- **Riser Card:** GHP-R0301 (32bit Ribbon) or GHP-R0304 (64bit Ribbon) (Optional)
- **Connector Port (Front):** 2x USB Ports
- **Thermal Management Card:** GHA-CO04
- **Indicators:** LEDs for Power ON/OFF, HDD Power/Access, Fan, Temperature
- **Switch:** Power ON/OFF Momentary (Pushbutton), System Reset, Buzzer Reset
- **Dimensions (W x H x D):** 483 x 88 x 650mm (19" x 3.5" x 25.6")
- **Cuft:** 4.4
- **GW:** 17.2 kgs / 37.9 lbs
- **Carton Size(cm):** 58.8 x 25.5 x 82.5 (23.1" x 10.0" x 32.5")
- **Humidity:** 5% - 95% Non-condensing-

Dimension

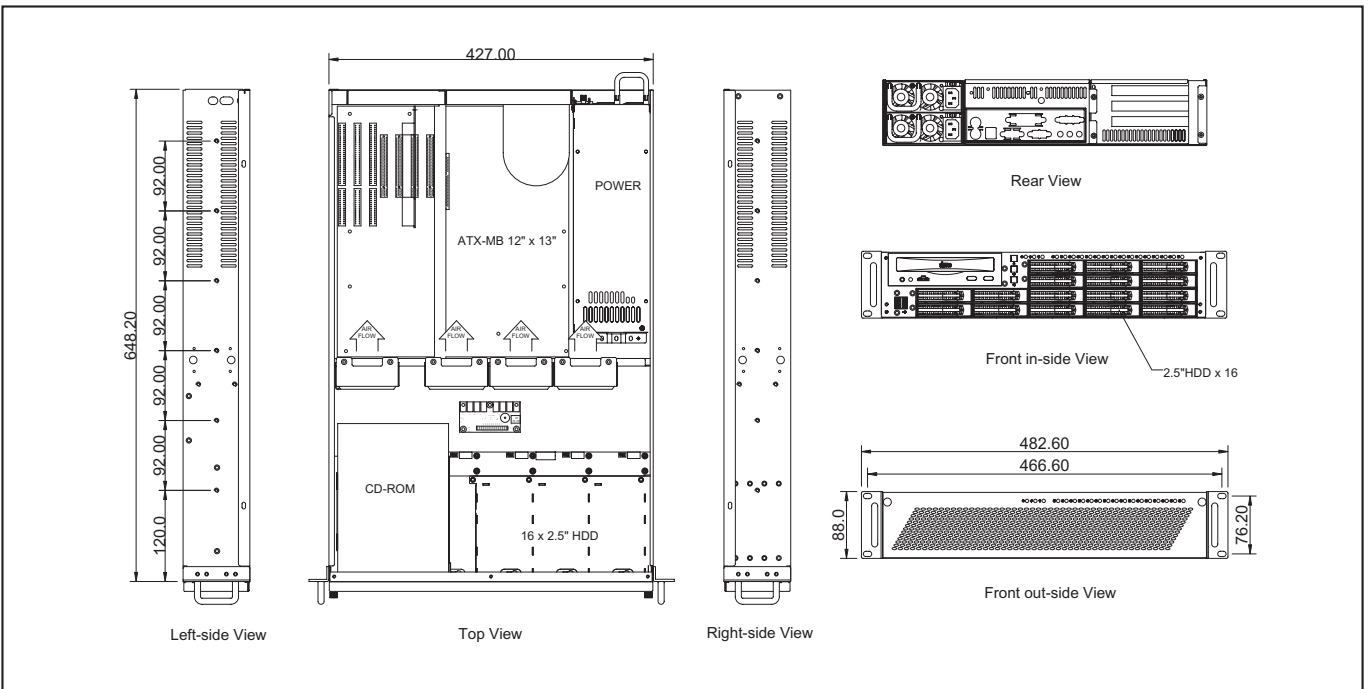

GHI-280/280V/280WV2

2U Rackmount Chassis



Specifications

- **EIA RS-310C 19" Rackmount Standard**
- **Construction:** Heavy Duty Cold Rolled Electroplated Steel
- **Color:** Black (Standard), Beige or Custom
- **System Boards:** Pentium 4, Dual Xeon, Athlon 64, Dual Opteron
- **Support EATX M/B (Max. to 12" x 13") SSI EEB 3.0**
- **Drive Capacity:** 1x Slim CD-ROM & 1x Slim FDD & 8x 3.5" Swappable Trays & 2x 2.5"HDD & 1x3.5"HDD (Optional)
- **Drive Interface:** PATA, SATA, SCSI320, Multilane SATA or SAS
- **Power Supply (Optional):** 2U Single up to 600W or 2U Redundant up to 500W ATX P/S(Rear Installation) Max. Depth 300mm
- **Cooling:** 4x (80mm = 42.5CFM ea.) Fans
- **Front Door:** Single Door with 2 Thumbscrews (Removable)
- **Riser Card:** GHP-R0301 (32bit Ribbon) or GHP-R0304 (64bit Ribbon) (Optional)
- **Connector Port (Front):** 2x USB Ports
- **Expansion Slots(Optional):** 2 or 3x Horizontal ISA/PCI/AGP Option Slots(GHI-280)
7x Low Profile PCI Slots(GHI-280V)
6x Horizontal Slots(3 Slots 64Bit ea.)(GHI-280WV2)
- **Thermal Management Card:** GHA-CO04
- **Indicators:** LEDs for Power ON/OFF, HDD Activity, Fan, Temperature, LAN
- **Switch:** Power ON/OFF Momentary (Pushbutton), System Reset, Buzzer Reset
- **Dimensions (WxHxD):** 483x88x650mm (19" x 3.5" x 25.6")
- **Cuft:** 4.4
- **GW:** 18.5kgs / 40.8lbs
- **Carton Size(cm):** 58.8 x 25.5 x 82.5 (23.1" x 10.0" x 32.5")
- **Humidity:** 5% - 95% Non-condensing

Dimension

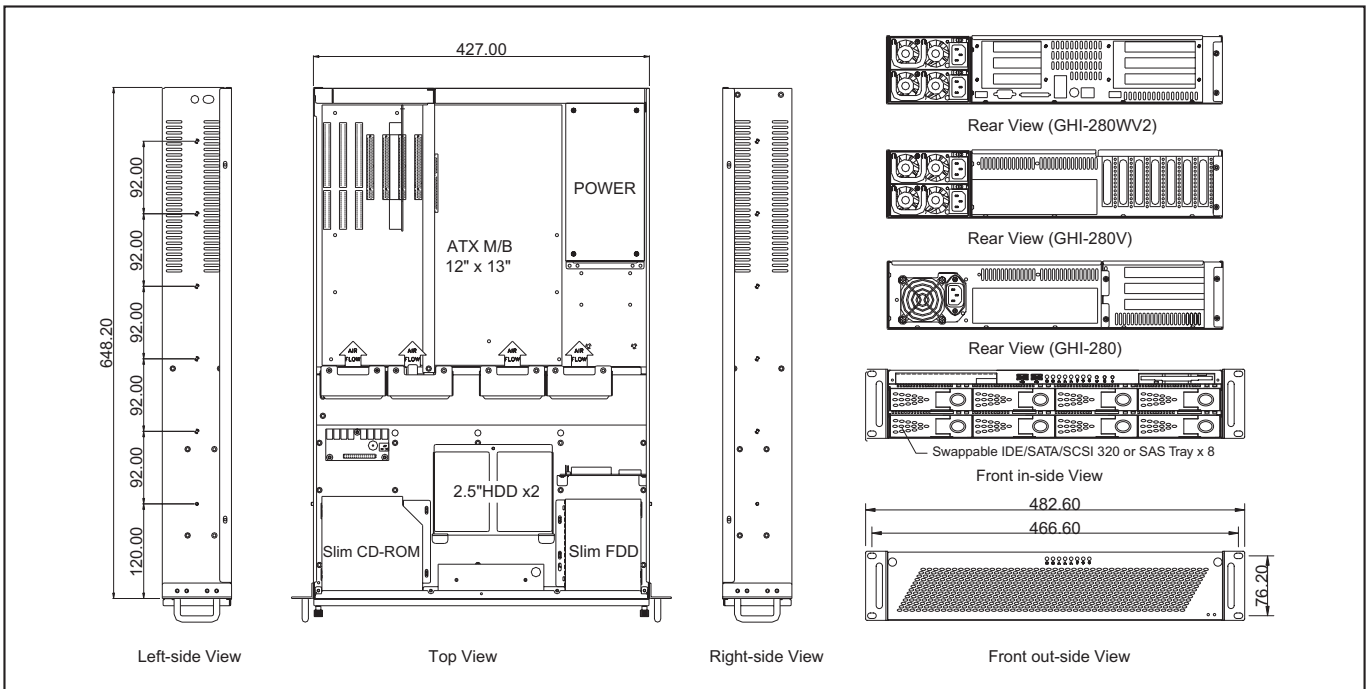

GHI-281/281V/281WV2

2U Rackmount Chassis



19" Rackmount

Specifications

- **EIA RS-310C 19" Rackmount Standard**
- **Construction:** Heavy Duty Cold Rolled Electroplated Steel
- **Color:** Black (Standard), Beige or Custom
- **System Boards:** Pentium 4, Dual Xeon, Athlon 64, Dual Opteron
- **Support EATX M/B (Max. to 12" x 13") SSI EEB 3.0**
- **Drive Capacity:** 1x 5.25" & 1x Slim FDD & 6x 3.5" Swappable Trays & 1x 2.5"HDD
- **Drive Interface:** PATA, SATA, SCSI320 or SAS
- **Power Supply (Optional):** 2U Single up to 600W or 2U Redundant up to 500W ATX P/S(Rear Installation) Max. Depth 300mm
- **Cooling:** 4x (80mm = 42.5CFM ea.) Fans
- **Front Door:** Single Door with 2 Thumbscrews (Removable)
- **Riser Card:** GHP-R0301 (32bit Ribbon) or GHP-R0304 (64bit Ribbon) (Optional)
- **Connector Port (Front):** 2x USB Ports
- **Expansion Slots(Optional):** 2 or 3x Horizontal ISA/PCI/AGP Option Slots(GHI-281)
7x Low Profile PCI Slots(GHI-281V)
6x Horizontal Slots(3 Slots 64Bit ea.)(GHI-281WV2)
- **Thermal Management Card:** GHA-CO04
- **Indicators:** LEDs for Power ON/OFF , HDD Activity, Fan, Temperature, LAN
- **Switch:** Power ON/OFF Momentary (Pushbutton), System Reset, Buzzer Reset
- **Dimensions (WxHxD):** 483x88x650mm (19" x 3.5" x 25.6")
- **Cuft:** 4.4
- **GW:** 18.5kgs / 40.8lbs
- **Carton Size(cm):** 58.8 x 25.5 x 82.5 (23.1" x 10.0" x 32.5")
- **Humidity:** 5% - 95% Non-condensing

Dimension

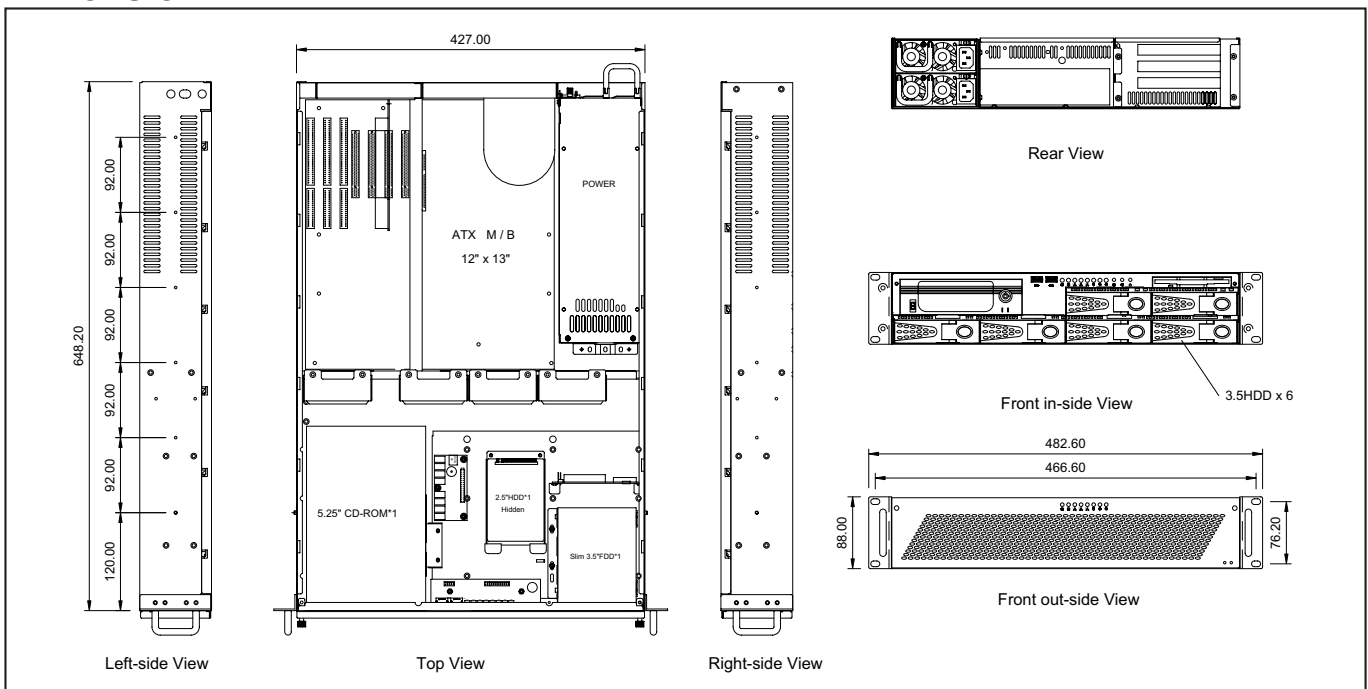

GHI-282/282V

2U Rackmount Chassis

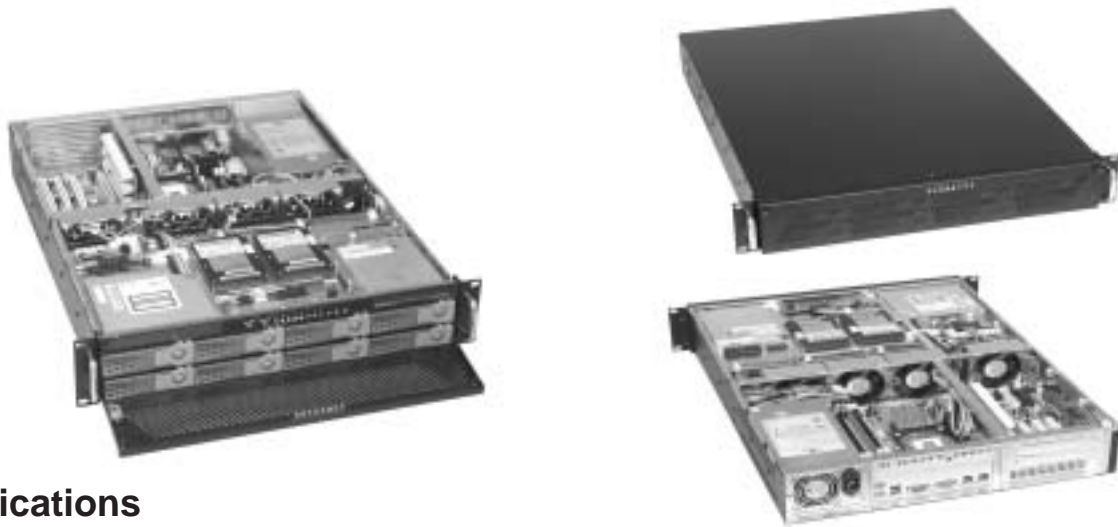

Specifications

- **EIA RS-310C 19" Rackmount Standard**
- **Construction:** Heavy Duty Cold Rolled Electroplated Steel
- **Color:** Black (Standard), Beige or Custom
- **System Boards:** Pentium 4, Dual Xeon, Athlon 64
- **Support ATX M/B (Max. to 12" x 9.6")**
- **Drive Capacity:** 1x Slim CD-ROM & 1x Slim FDD & 8x 3.5" Swappable Trays & 2x 2.5"HDD
- **Drive Interface:** PATA, SATA, SCSI320, Multilane SATA or SAS
- **Power Supply (Optional):** 2U Single up to 510W or Redundant up to 400W ATX P/S (Rear Installation) Max. Depth 240mm
- **Cooling:** 4x (80mm = 42.5CFM ea.) Fan
- **Front Door:** Single Door with 2 Thumbscrews(Removable)
- **Riser Card:** GHP-R0301 (32bit Ribbon) or GHP-R0304 (64bit Ribbon) (Optional)
- **Connector Port (Front):** 2x USB Ports
- **Expansion Slots (Optional):** 2 or 3x Horizontal ISA/PCI/AGP Option Slots(GHI-282)
7x Low Profile PCI Slots(GHI-282V)
- **Thermal Management Card:** GHA-CO04
- **Indicators:** LEDs for Power ON/OFF, HDD Activity, Fan, Temperature, LAN
- **Switch:** Power ON/OFF Momentary (Pushbutton), System Reset, Buzzer Reset
- **Dimensions (WxHxD):** 483x88x565mm (19" x 3.5" x 22.2")
- **Cuft:** 3.9
- **GW:** 17.5kgs / 38.5lbs
- **Carton Size(cm):** 58.8 x 25.5 x 74.5 (23.1" x 10.0" x 29.3")
- **Humidity:** 5% - 95% Non-condensing

Dimension

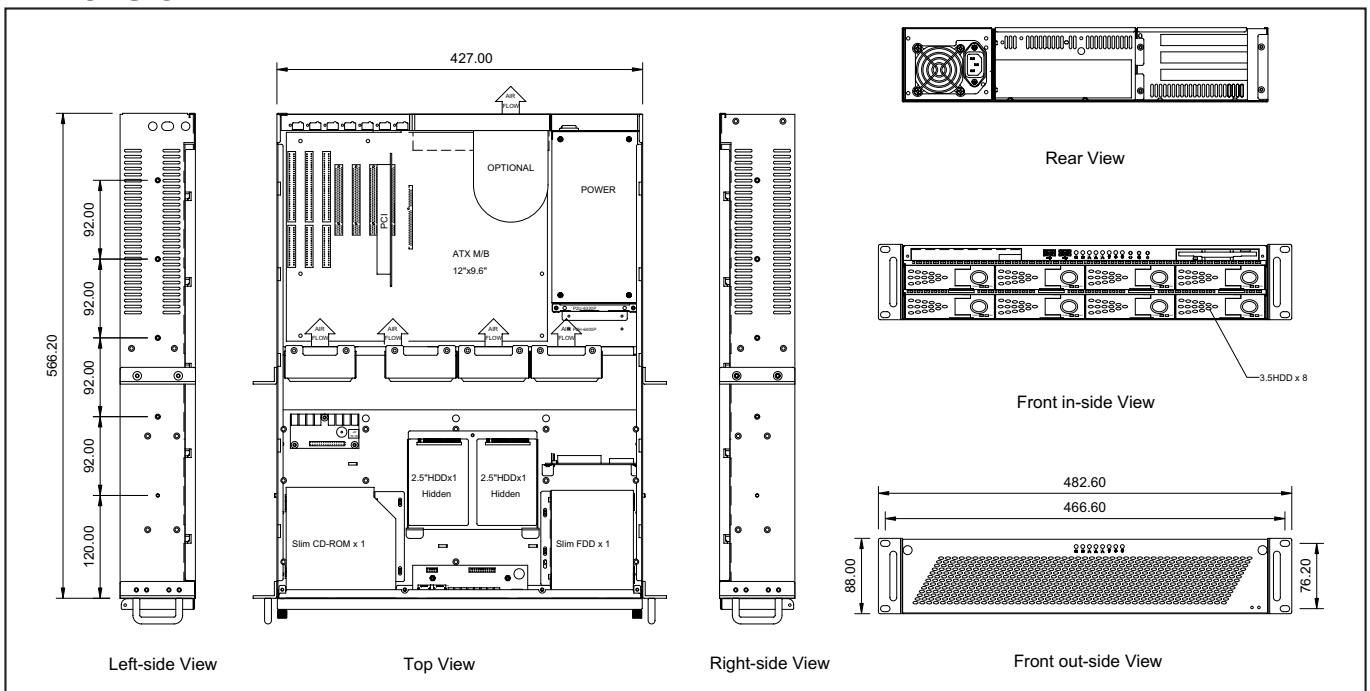

GHI-283/283V/283WV2

2U Rackmount Chassis



19" Rackmount

Specifications

- **EIA RS-310C 19" Rackmount Standard**
- **Construction:** Heavy Duty Cold Rolled Electroplated Steel
- **Color:** Black (Standard), Beige or Custom
- **System Boards:** Dual Xeon, Pentium 4, Athlon 64, Dual Opteron
- **Support EATX M/B (Max. to 12" x 13") SSI EEB 3.0**
- **Drive Capacity:** 2x 5.25" & 1x 3.5" HDD & 4x 3.5" Swappable Trays
- **Drive Interface:** PATA, SATA, SCSI320, Multilane SATA or SAS
- **Power Supply (Optional):** 2U Single up to 600W or 2U Redundant up to 500W ATX P/S(Rear Installation) Max. Depth 300mm
- **Cooling:** 4x (80mm = 42.5CFM ea.)Fans
- **Front Door:** Single Door with 2 Thumbscrews (Removable)
- **Riser Card:** GHP-R0301 (32bit Ribbon) or GHP-R0304 (64bit Ribbon) (Optional)
- **Connector Port (Front):** 2x USB Ports
- **Expansion Slots(Optional):** 2 or 3x Horizontal ISA/PCI/AGP Option Slots(GHI-283)
7x Low Profile PCI Slots(GHI-283V)
6x Horizontal Slots(3 Slots 64Bit ea.)(GHI-283WV2)
- **Indicators:** LEDs for Power ON/OFF, HDD Activity, Fan, Temperature, LAN
- **Switch:** Power ON/OFF Momentary (Pushbutton), System Reset, Buzzer Reset
- **Dimensions (WxHxD):** 483x88x650mm (19" x 3.5" x 25.6")
- **Cuft:** 4.4
- **GW:** 18.5kgs / 40.8lbs
- **Carton Size(cm):** 58.8 x 25.5 x 82.5 (23.1" x 10" x 32.5")
- **Humidity:** 5% - 95% Non-condensing

Dimension

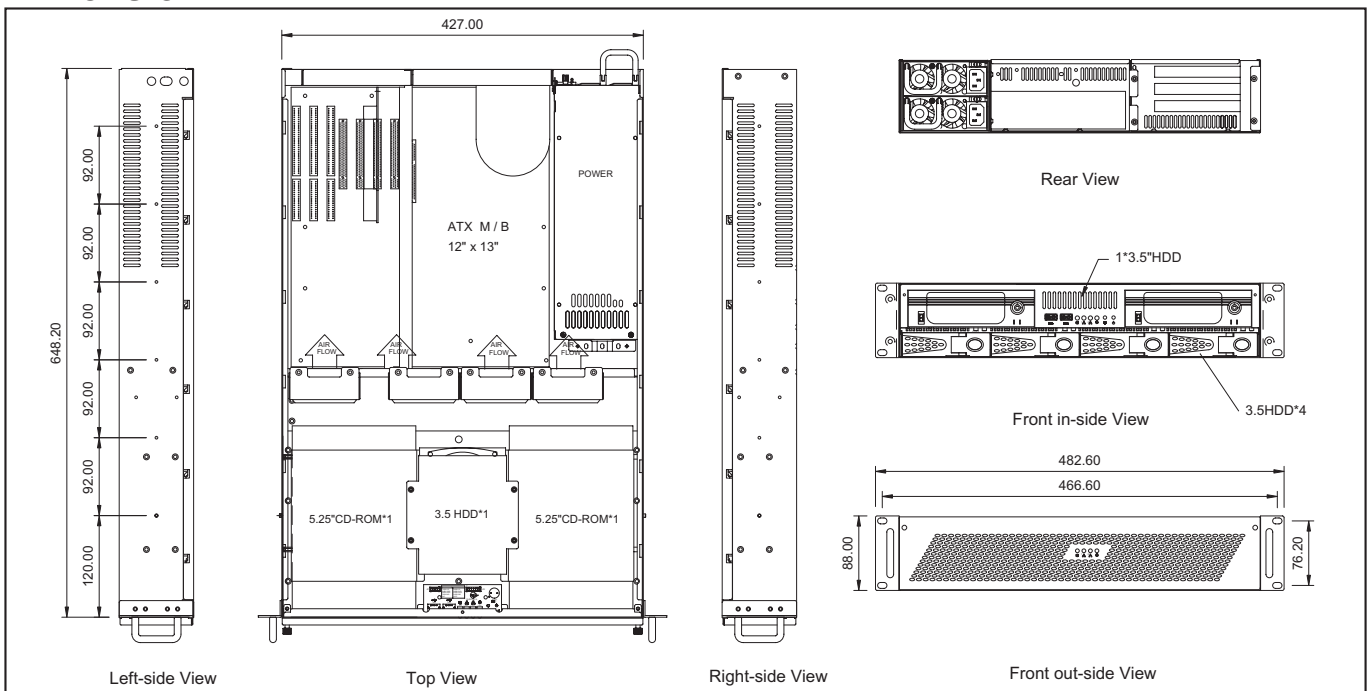

GH-288SR

2U Rackmount Chassis



Specifications

- **EIA RS-310C 19" Rackmount Standard**
- **Construction:** Heavy Duty Cold Rolled Electroplated Steel
- **Color:** Black (Standard), Beige or Custom
- **Support 6-slot Passive Backplane**
- **Drive Capacity:** 1x 5.25" & 1x 3.5" & 2x 3.5" HDD
- **Power Supply (Optional):** PS/2 size Single up to 700W or Mini Redundant up to 500W P/S (Rear Installation)
- **Cooling:** 2x (80mm = 42.5CFM ea.) Fans
- **Front Door:** Drive panel door with Keylock
- **Air Filter:** Inside Front Panel (Washable)
- **Connector Port (Front):** 1x PS/2 Port
- **Indicators:** LEDs for Power ON/OFF, HDD Activity
- **Switch:** Power ON/OFF Momentary (Rocker), System Reset
- **Dimensions (WxHxD):** 483x88x526mm (19" x 3.5" x 20.7")
- **Cuft:** 3.6
- **GW:** 15.0kgs / 33.1lbs
- **Carton Size(cm):** 58.8 x 25.5 x 68.5 (23.1" x 10.0" x 27.0")
- **Humidity:** 5% - 95% Non-condensing

Dimension

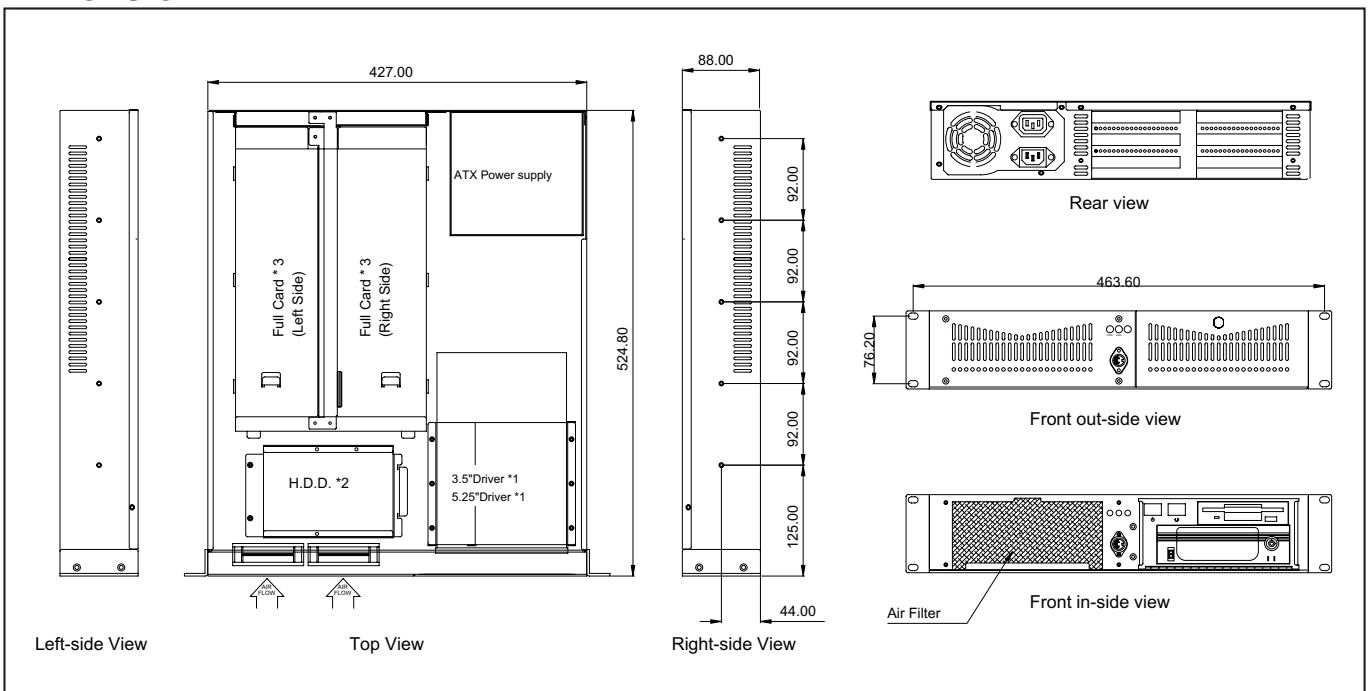

GHI-289

2U Rackmount Chassis

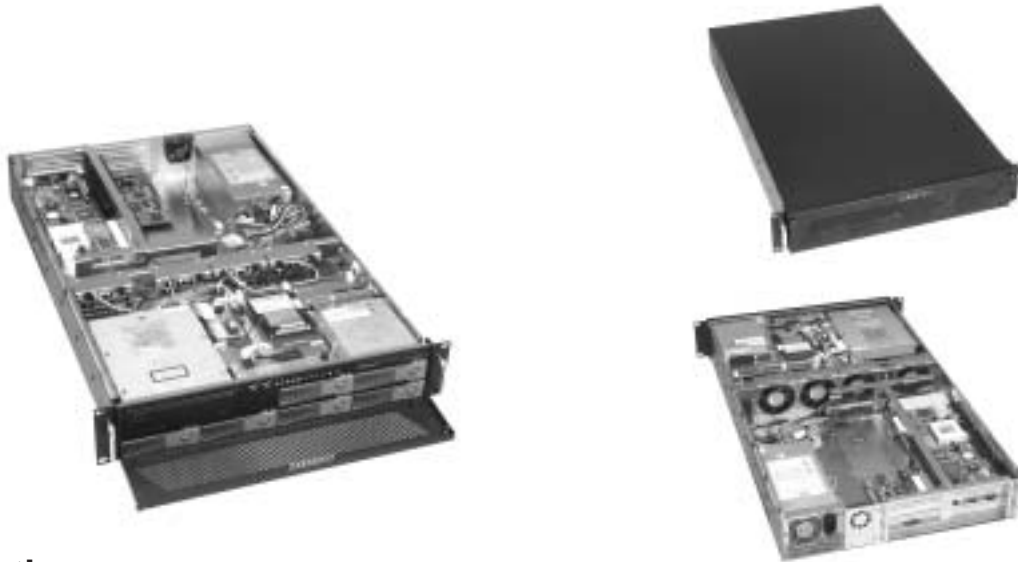

19" Rackmount

Specifications

- **EIA RS-310C 19" Rackmount Standard**
- **Construction:** Heavy Duty Cold Rolled Electroplated Steel
- **Color:** Black (Standard), Beige or Custom
- **Supports 6 Slot Passive Backplane**
- **Drive Capacity:** 1x 5.25", 1x Slim FDD, 6x Hot Swappable Drive Tray & 1x 2.5" HDD
- **Drive Interface:** PATA, SATA, SCSI320 or SAS
- **Power Supply (Optional):** 2U Single up to 600W or 2U Redundant up to 500W ATX P/S ea. (Rear Installation) Max Depth 300mm
- **Cooling:** 4x (80mm = 42.5CFM ea.) Fans & 1x (40mm = 15.3CFM ea.) Fans
- **Front Door:** Single Door with 2 Thumbscrews (Removable)
- **Connector Port (Front):** 2x USB Ports
- **Thermal Management Card:** GHA-CO04
- **Indicators:** LEDs for Power ON/OFF, 2x HDD, Fan, & 3x LAN Activity
- **Switch:** Power ON/OFF Momentary(Rocker), System Reset
- **Dimensions (WxHxD):** 483x88x696mm (19" x 3.5" x 25.6")
- **Cuft:** 4.6
- **GW:** 18.55kgs / 40.8lbs
- **Carton Size (cm):** 86.1 x 25.5 x 59.5 (33.9" x 10.0" x 23.4")
- **Humidity:** 5% - 95% Non-condensing

Dimension

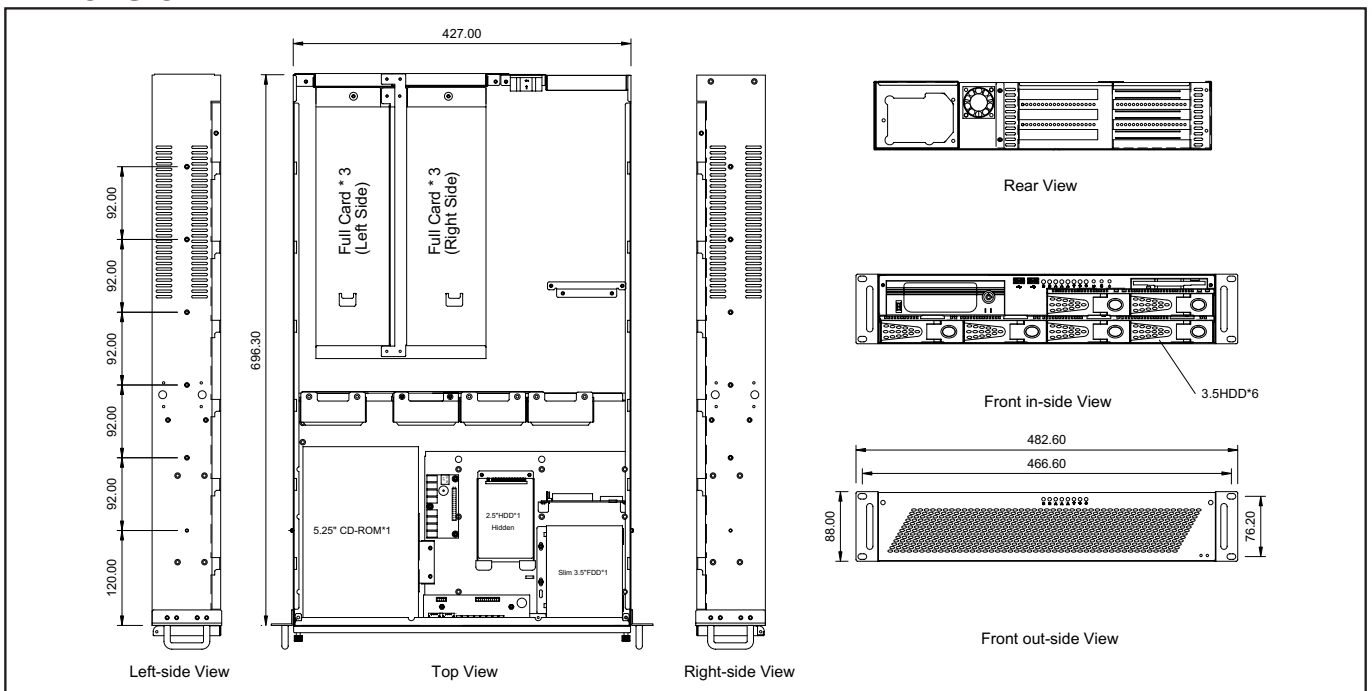

GHI-290/290V/290WV2

2U Rackmount Chassis



Specifications

- **EIA RS-310C 19" Rackmount Standard**
- **Construction:** Heavy Duty Cold Rolled Electroplated Steel
- **Color:** Black (Standard), Beige or Custom
- **System Boards:** Pentium 4, Dual Xeon, Athlon 64, Dual Opteron
- **Support EATX M/B (Max. to 12" x 13") SSI EEB 3.0**
- **Drive Capacity:** 12x 3.5" Swappable Trays
- **Drive Interface:** SATA, SCSI320, Multilane SATA or SAS
- **Power Supply (Optional):** 2U Single up to 600W or 2U Redundant up to 500W ATX P/S(Rear Installation) Max. Depth 300mm
- **Cooling:** 4x (80mm = 42.5CFM ea.) Fans
- **Front Door:** Double Horizontal Doors with 2 Thumbscrews
- **Riser Card:** GHP-R0301 (32bit Ribbon) or GHP-R0304 (64bit Ribbon) (Optional)
- **Expansion Slots(Optional):** 2 or 3x Horizontal ISA/PCI/AGP Option Slots(GHI-290) or 7x Low Profile PCI Slots(GHI-290V) or 6x Horizontal Slots(3 Slots 64Bit ea.)(GHI-290WV2)
- **Thermal Management Card:** GHA-CO08
- **Indicators:** LEDs for Power ON/OFF, HDD Activity, Fan, Temperature, LAN
- **Switch:** Power ON/OFF Momentary (Pushbutton), System Reset, Buzzer Reset
- **Dimensions (WxHxD):** 483x88x650mm (19" x 3.5" x 25.6")
- **Cuft:** 4.4
- **GW:** 18.5kgs / 40.8lbs
- **Carton Size(cm):** 58.8 x 25.5 x 82.5 (23.1" x 10.0" x 32.5")
- **Humidity:** 5% - 95% Non-condensing

Dimension

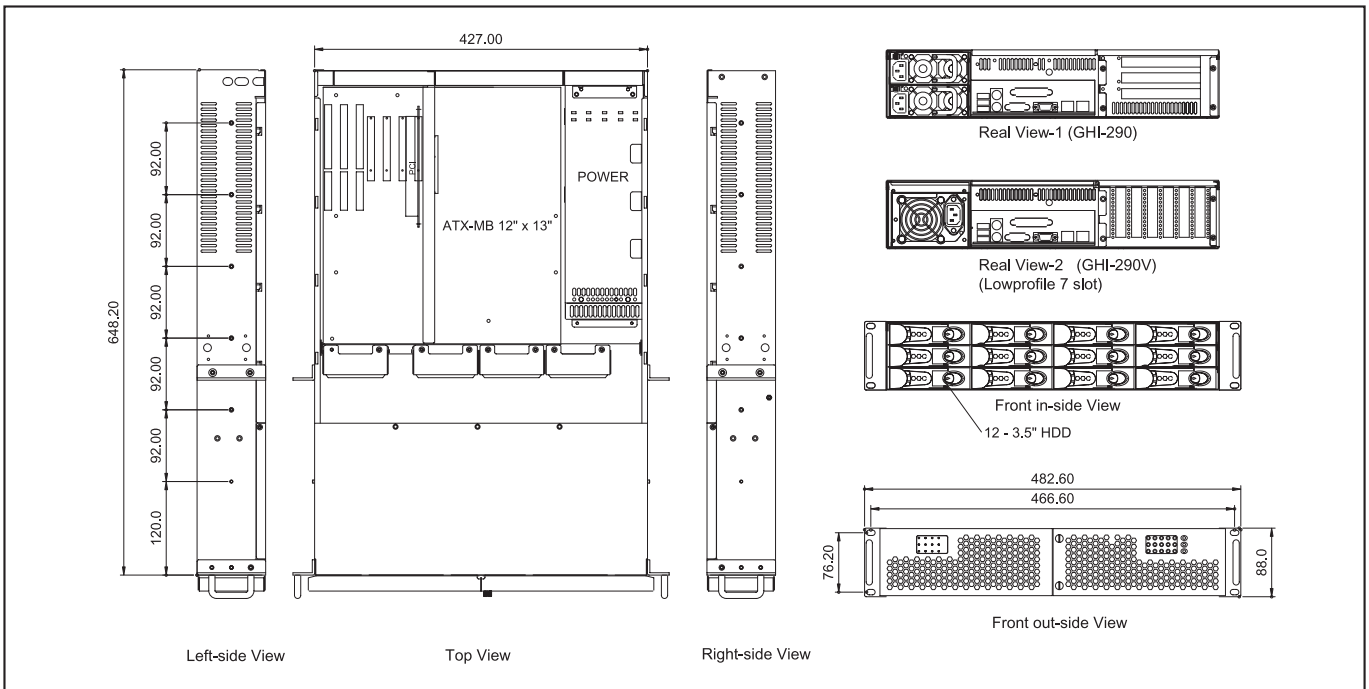

GHI-293

2U Rackmount Chassis



Specifications

- **EIA RS-310C 19" Rackmount Standard**
- **Construction:** Heavy Duty Cold Rolled Electroplated Steel
- **Color:** Black (Standard), Beige or Custom
- **System Boards:** Dual Xeon, Pentium 4, Athlon 64, Dual Opteron
- **Support EATX M/B (Max. to 12" x 10.5") SSI EEB 3.0**
- **Drive Capacity:** 2x 5.25" & 1x 3.5" FDD & 4x 3.5" Swappable Trays
- **Drive Interface:** PATA, SATA, SCSI320, Multilane SATA or SAS
- **Power Supply (Optional):** 2U Single up to 600W or 2U Redundant up to 500W ATX P/S(Rear Installation) Max. Depth 300mm
- **Cooling:** 3x (80mm = 42.5CFM ea.) Fans
- **Front Door:** Single Door With 2 Thumbscrews (Removable)
- **Riser Card:** GHP-R0301 (32bit Ribbon) or GHP-R0304 (64bit Ribbon) (Optional)
- **Connector Port (Front):** 2x USB Ports
- **Expansion Slots(Optional):** 2 or 3x Horizontal ISA/PCI/AGP Option Slots(GHI-293H) 7x Low Profile PCI Slots(GHI-293V)
- **Indicators:** LEDs for Power ON/OFF, 4xHDD Activity, Fan, Temperature, LAN
- **Switch:** Power ON/OFF Momentary (Pushbutton), System Reset, Buzzer Reset
- **Dimensions (W x H x D):** 483 x 88 x 560mm (19" x 3.5" x 22.1")
- **Cuft:** 3.3
- **GW:** 13.9kgs / 30.7lbs
- **Carton Size(cm):** 57.0 x 22.0 x 73.5 (22.4" x 8.7" x 28.9")
- **Humidity:** 5% - 95% Non-condensing

Dimension

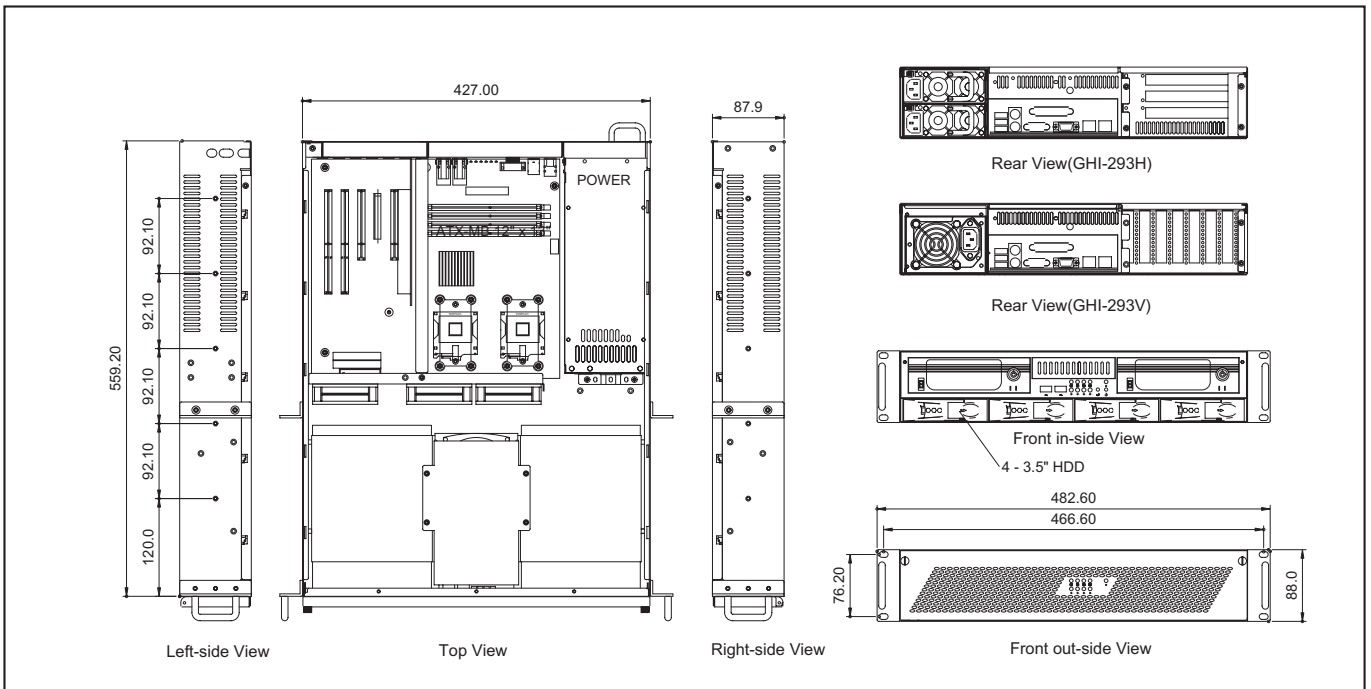

GH-310ATXR

3U Rackmount Chassis



Specifications

- **EIA RS-310C 19" Rackmount Standard**
- **Construction:** Heavy Duty Cold Rolled Electroplated Steel
- **Color:** Black (Standard), Beige or Custom
- **System Boards:** Dual Xeon, Pentium 4, Athlon 64, Dual Opteron, Pentium 4
- **Support ATX M/B (Max. to 12" x 9.6")**
- **Drive Capacity:** 2x 5.25" & 1x 3.5" & 5x 3.5" HDD
- **Power Supply (Optional):** PS/2 size single up to 700W or Mini Redundant up to 500W ATX P/S (Front/Mid Installation) Max. Depth of 205mm
- **Cooling:** 1x (80mm = 42.5CFM ea.) & 2x (92mm = 51CFM ea.) Fans
- **Front Door:** Single Door with 1 Thumb Twist Keylock
- **Air Filter:** Inside Front Door (Washable)
- **Expansion Slots:** 7 slot
- **Indicators:** LEDs for Power ON/OFF, HDD Activity
- **Switch:** Power ON/OFF Momentary (Rocker), System Reset
- **Dimensions (WxHxD):** 483x133x526mm(19" x 5.2" x 20.7")
- **Cuft:** 4.2
- **GW:** 16.0kgs / 35.3lbs
- **Carton Size(cm):** 58.8 x 28.5 x 70.3 (23.1" x 11.2" x 27.7")
- **Humidity:** 5% - 95% Non-condensing

Dimension

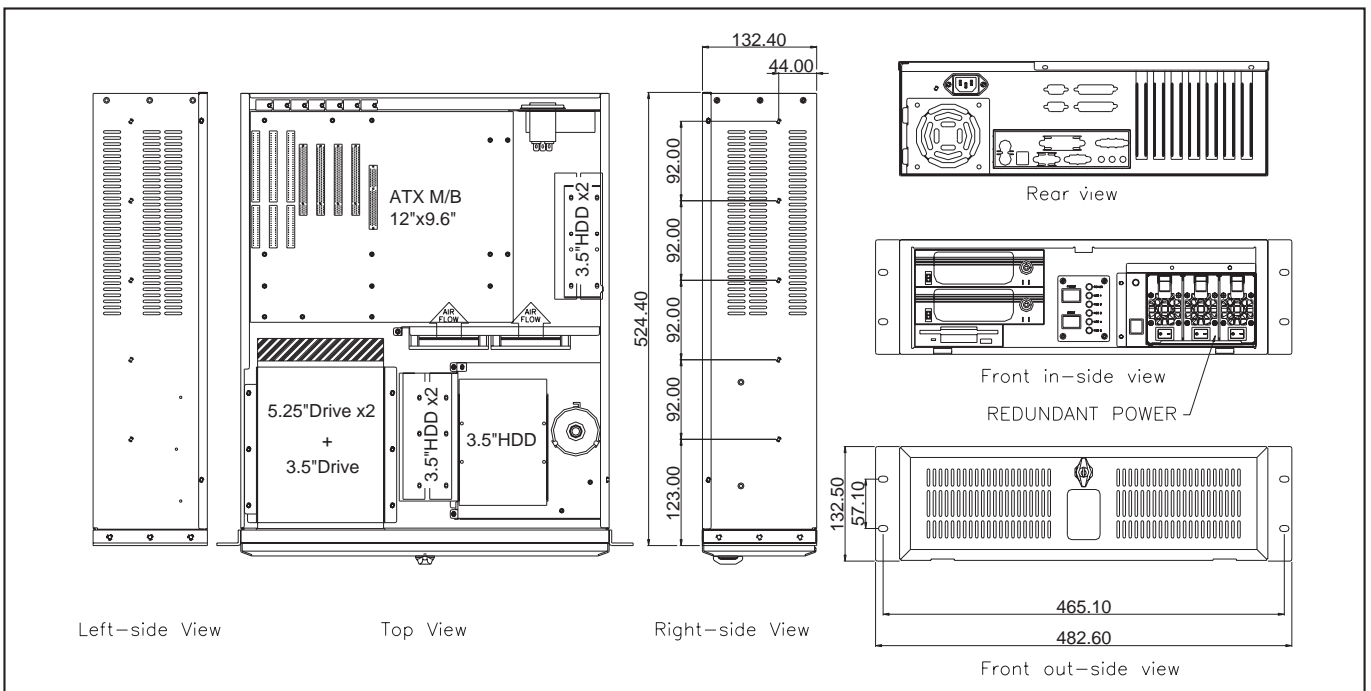

GHI-312

3U Rackmount Chassis



Specifications

- **EIA RS-310C 19" Rackmount Standard**
- **Construction:** Heavy Duty Cold Rolled Electroplated Steel
- **Color:** Black (Standard), Beige or Custom
- **System Boards:** Dual Xeon, Pentium 4, Athlon 64, Dual Opteron
- **Support EATX M/B (Max. to 12" x 13") SSI EEB 3.0**
- **Drive Capacity:** 2x 5.25" & 1x 3.5" & 7x 3.5" HDD & 2x 3.5" HDD (Optional)
- **Power Supply (Optional):** 2U Single up to 700W or 2U Redundant up to 500W ATX P/S (Rear Installation) Max. Depth 300mm
- **Cooling:** 5x (92mm = 51CFM ea.) & 1x (60mm = 23.5CFM ea.) Fans
- **Front Door:** Single Door with 1 Thumb Twist Keylock
- **Air Filter:** Inside Front Door (Washable)
- **Connector Port (Front):** 2x USB Ports
- **Expansion Slots:** 7 slot
- **Indicators:** LEDs for Power ON/OFF, HDD Activity
- **Switch:** Power ON/OFF Momentary(Rocker), System Reset
- **Dimensions (WxHxD):** 483x133x650mm (19" x 5.2" x 25.6")
- **Cuft:** 5.3
- **GW:** 13.0kgs / 28.7lbs
- **Carton Size(cm):** 81.8 x 59.4 x 31.0 (32.2" x 23.4" x 12.2")
- **Humidity:** 5% - 95% Non-condensing

Dimension

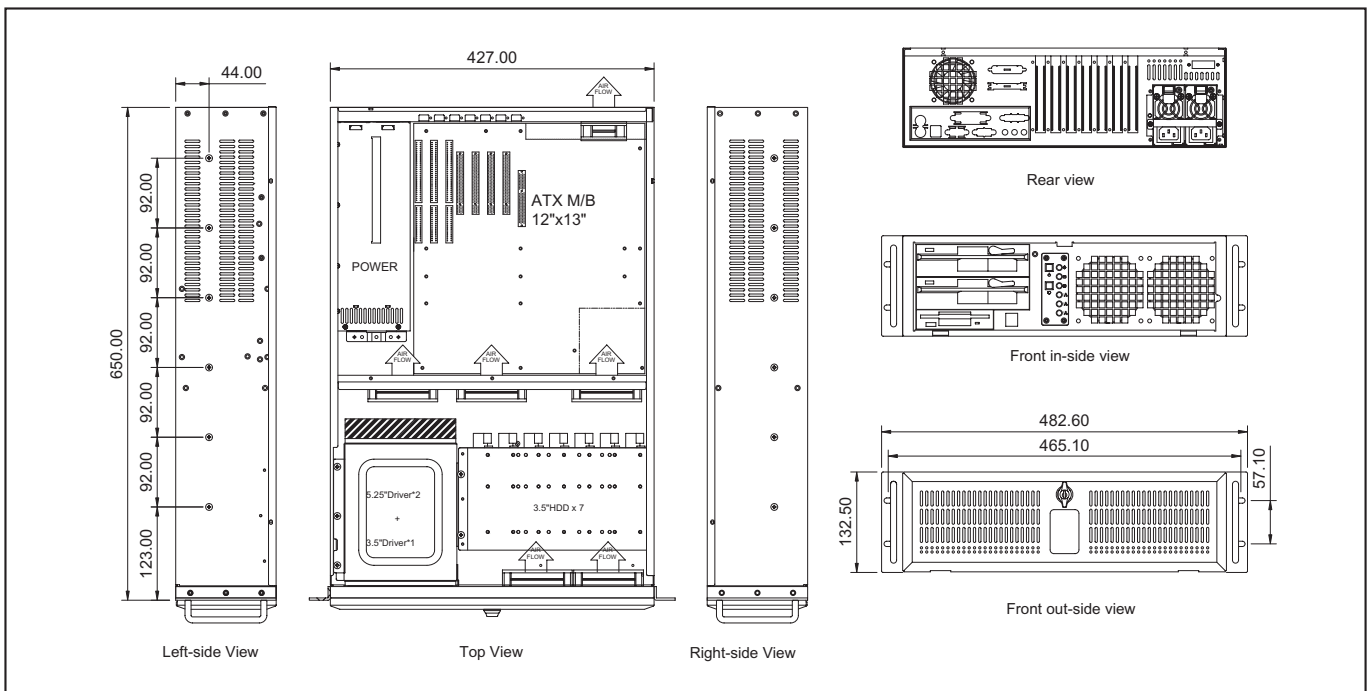

GHI-313

3U Rackmount Chassis

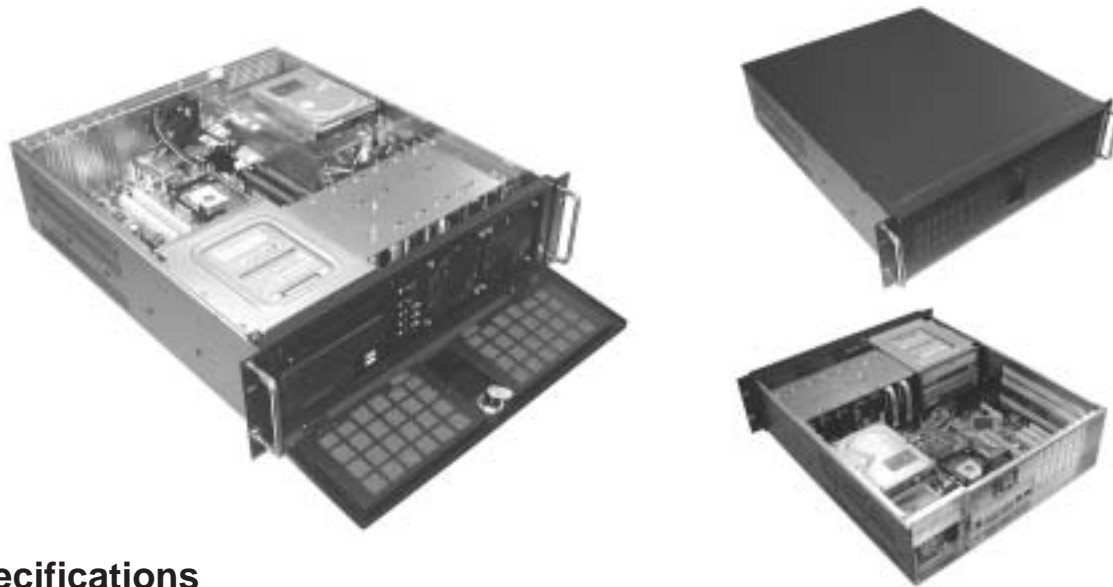

Specifications

- **EIA RS-310C 19" Rackmount Standard**
- **Construction:** Heavy Duty Cold Rolled Electroplated Steel
- **Color:** Black (Standard), Beige or Custom
- **System Boards:** Pentium 4, Dual Xeon, Athlon 64
- **Supports ATX M/B (Max. to 12" x 10.5")**
- **Drive Capacity:** 2x 5.25", 1x 3.5" FDD & 7x 3.5" HDD & 1x 3.5" HDD (Optional)
- **Power Supply (Optional):** 2U Single up to 600W or 2U Redundant up to 500W ATX P/S ea. (Rear Installation) Max Depth 250mm
- **Cooling:** 2x (92mm = 51CFM ea.) Fans & 1x (60mm = 23.5CFM ea.) Fan
- **Front Door:** Single Door with 1 Thumb Twist Keylock
- **Air Filter:** Inside Front Door (Washable)
- **Connector Port (Front):** 2x USB Ports
- **Indicators:** LEDs for Power ON/OFF, 2x HDD, Fan, & 3x LAN Activity
- **Switch:** Power ON/OFF Momentary (Rocker), System Reset
- **Dimensions (WxHxD):** 483x133x 526mm (19" x 5.2" x 20.7")
- **Cuft:** 4.2
- **GW:** 14.7kgs / 32.4lbs
- **Carton Size (cm):** 58.8 x 28.5 x 70.3 (23.1" x 11.2" x 27.7")
- **Humidity:** 5% - 95% Non-condensing

Dimension

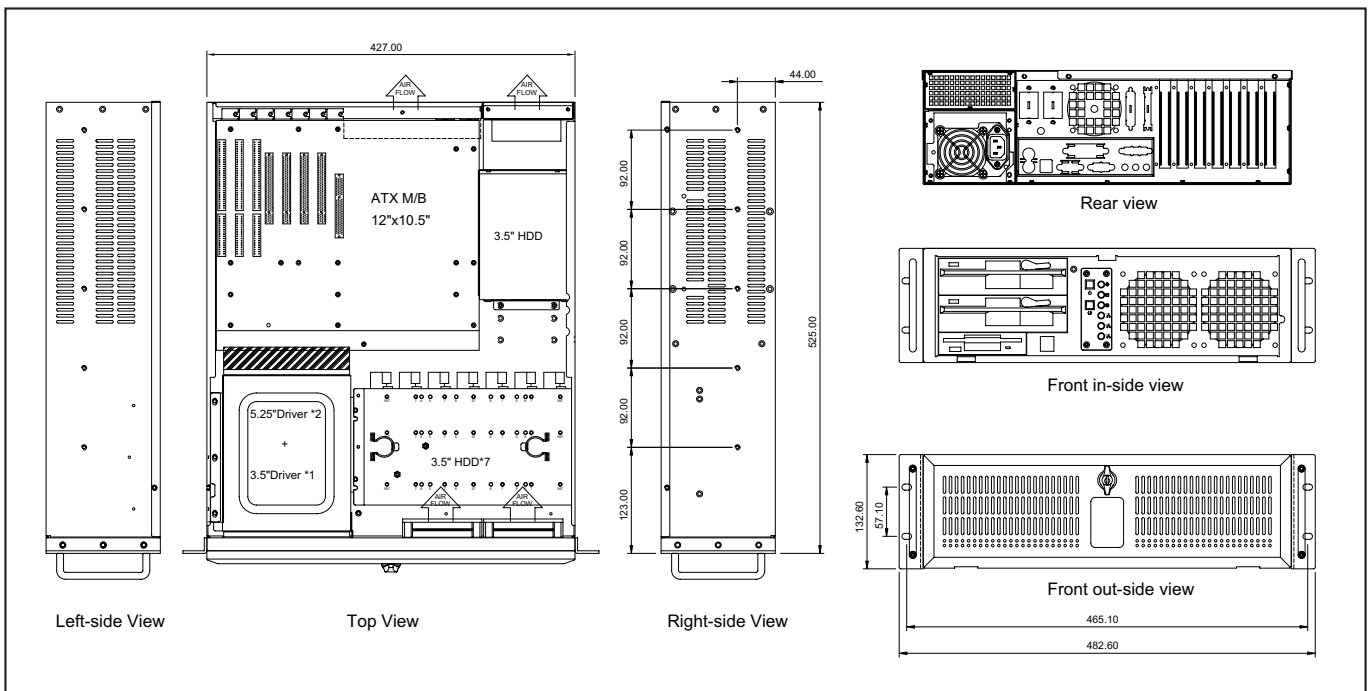

GHI-314

3U Rackmount Chassis



19" Rackmount

Specifications

- **EIA RS-310C 19" Rackmount Standard**
- **Construction:** Heavy Duty Cold Rolled Electroplated Steel
- **Color:** Black (Standard), Beige or Custom
- **System Boards:** Pentium 4, Dual Xeon, Athlon 64
- **Supports ATX M/B (Max. to 12" x 10.5")**
- **Drive Capacity:** 2x 5.25" , 4x 3.5" Swappable Trays
- **Drive Interface:** SCSI320, SATA or SAS
- **Power Supply (Optional):** 2U Single up to 510W or 2U Redundant up to 400W ATX P/S (Rear Installation) Max Depth 250mm
- **Cooling:** 1x (120mm = 108CFM ea.) & 2x (60mm = 23.5CFM ea.) & 4x (40mm = 15.3CFM ea.) Fans
- **Connector Port (Front):** 2x USB Ports
- **Indicators:** LEDs for Power ON/OFF, HDD Activity, LAN
- **Switch:** Power ON/OFF Momentary (Rocker), System Reset
- **Dimensions (W x H x D):** 483 x 133 x 524mm (19" x 5.2" x 20.6")
- **Cuft:** 4.2
- **GW:** 15.5kgs / 34.2lbs
- **Carton Size (cm):** 58.8 x 28.5 x 70.3 (23.1" x 11.2" x 27.7")
- **Humidity:** 5% - 95% Non-condensing

Dimension

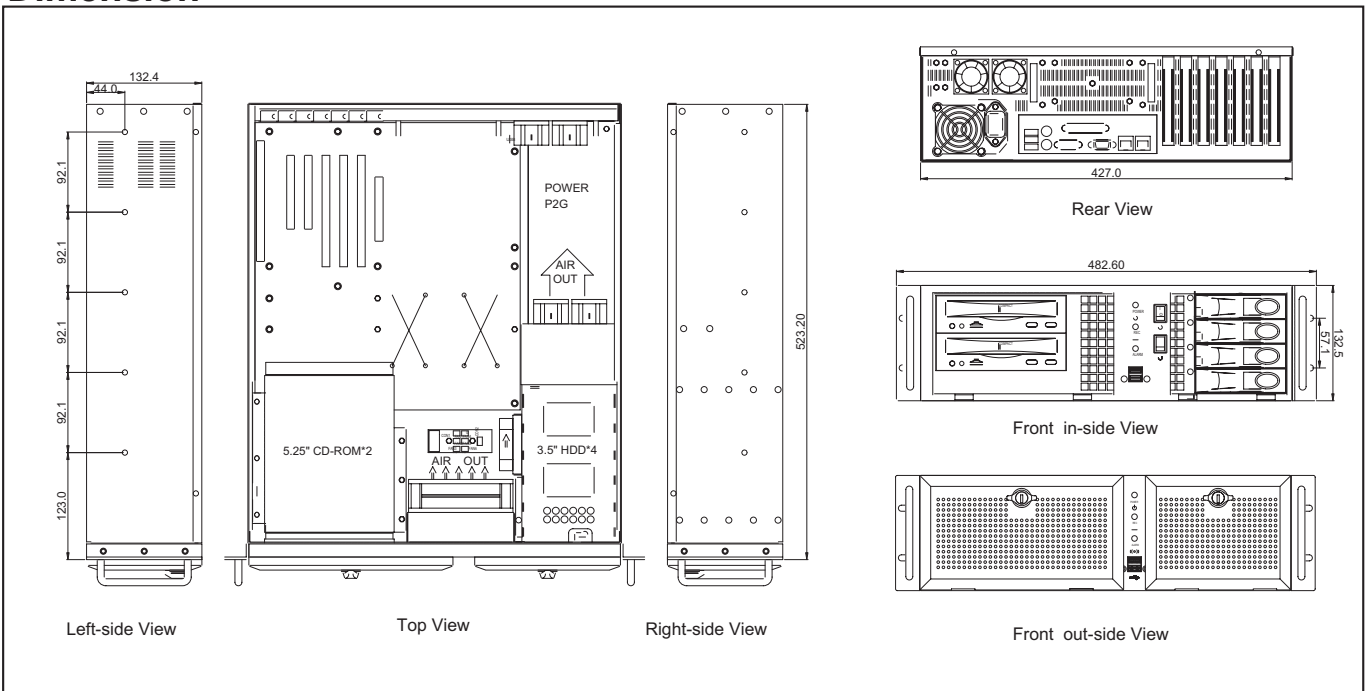

GH-315

3U Rackmount Chassis



Specifications

- **EIA RS-310C 19" Rackmount Standard**
- **Construction:** Heavy Duty Cold Rolled Electroplated Steel
- **Color:** Black (Standard), Beige or Custom
- **System Boards:** Pentium 4, Dual Xeon, Athlon 64, Dual Opteron
- **Support EATX M/B (Max. to 12" x 9.6") SSI EEB 3.0**
- **Drive Fnterface:** SCSI 320 , SATA or SAS
- **Drive Capacity:** 1x 5.25" Slim CD-ROM & 3x 3.5" Hot Swappable Trays
- **Power Supply(Optional):** 2U Single up to 600W or 2U Redundant up to 500W ATX PSU Max. Depth 300mm
- **Expansion Slots:** 7 slot Full Length
- **Front Door:** Two Doors With Thumb Twist Keylock
- **Cooling:** 1x (92mm = 51CFM ea.) & 2x (60mm = 23.5CFM ea.) Fans & 2x(40mm =7CFM ea.)
- **LCD:** 6.4" 640x480 Digital TFT Panel With Touch Screen
- **Indicators:** LEDs for Power ON/OFF, HDD,LAN Activity
- **Switch:** Power ON/OFF Momentary (Rocker), System Reset and Panel ON/OFF
- **Dimensions (W x H x D):** 483 x 133 x 526mm (19" x 5.2" x 20.7")
- **Cuft:** 4.2
- **GW:** 14.8kgs / 32.6lbs
- **Carton Size(cm):** 58.8 x 28.5 x 70.3(23.2" x 11.2" x 27.7")
- **Humidity:** 5% - 95% Non-condensing

Dimension

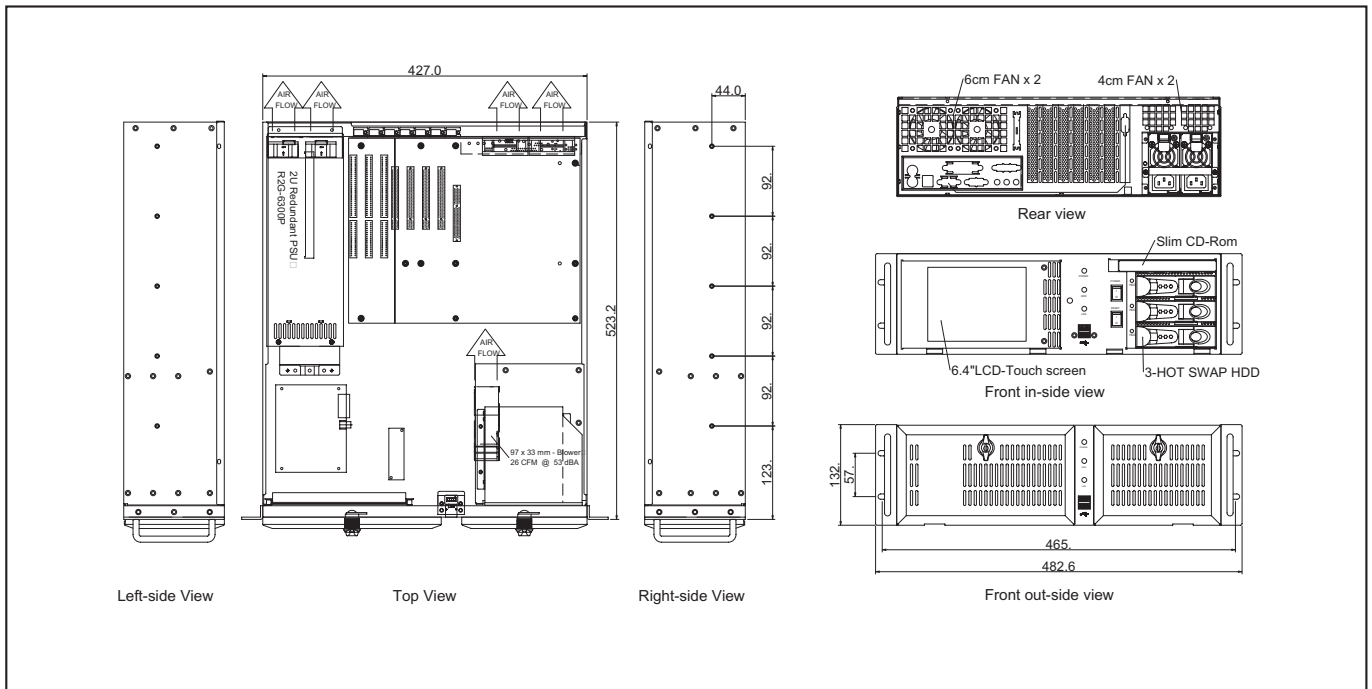

GH-341ATX

3U Rackmount Chassis



19" Rackmount

Specifications

- **EIA RS-310C 19" Rackmount Standard**
- **Construction:** Heavy Duty Cold Rolled Electroplated Steel
- **Color:** Black (Standard), Beige or Custom
- **System Boards:** Pentium 4, Dual Xeon, Athlon 64, Dual Opteron
- **Support EATX M/B (Max. to 12" x 13") SSI EEB 3.0**
- **Drive Interface:** SCSI 320, P-ATA
- **Drive Capacity:** 2x 5.25" & 2x 3.5" & 1x 3.5" HDD & 4x 3.5" Hot Swappable SCSI 320 Trays
- **Power Supply(Optional):** 2U Single up to 650W or 2U Redundant up to 500W ATX P/S (Rear Installation) Max. Depth 300mm
- **Cooling:** 3x (92mm = 51CFM ea.) & 1x (60mm = 23.5CFM ea.) Fans
- **Front Door:** Single Door with 1 Thumb Twist Keylock
- **Air Filter:** Inside Front Door (Washable)
- **Connector Port (Front):** 1x PS/2 Port
- **Expansion Slots:** 7 slot Full Length
- **Thermal Management Card:** GHA-CO01
- **Indicators:** LEDs for Power ON/OFF, HDD Activity
- **Switch:** Power ON/OFF Momentary(Rocker), System Reset
- **Dimensions(WxHxD):** 483x133x650mm (19" x 5.2" x 25.6")
- **Cuft:** 5.3
- **GW:** 13.0kgs / 39.7lbs
- **Carton Size(cm):** 59.4 x 31.0 x 81.8(23.4" x 12.2" x 32.2")
- **Humidity:** 5% - 95% Non-condensing

Dimension

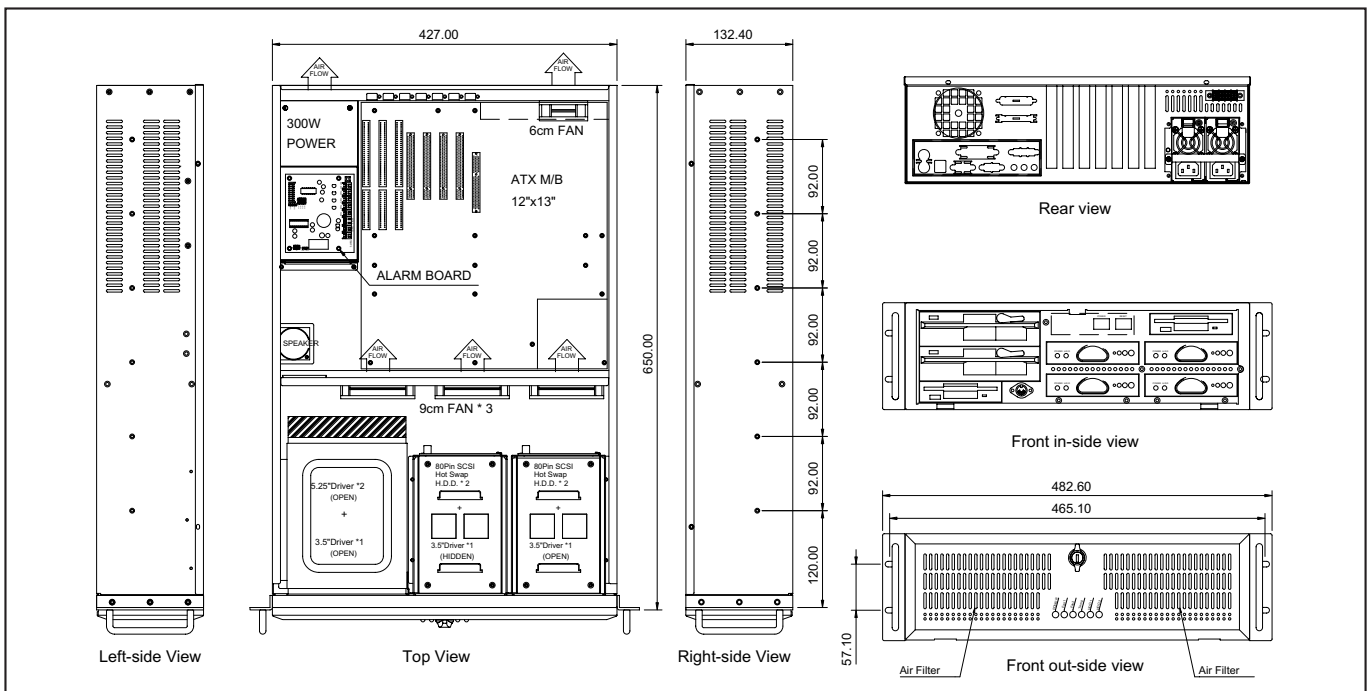

GH-342ATX

3U Rackmount Chassis



Specifications

- **EIA RS-310C 19" Rackmount Standard**
- **Construction:** Heavy Duty Cold Rolled Electroplated Steel
- **Color:** Black (Standard), Beige or Custom
- **System Boards:** Pentium 4, Dual Xeon, Athlon 64, Dual Opteron
- **Support ATX M/B (Max. to 12" x 13") SSI EEB 3.0**
- **Drive Interface:** P-ATA, SATA, SCSI320 or SAS
- **Drive Capacity:** 2x 5.25" & 1x 3.5" & 6x 3.5" Hot Swappable Trays
- **Power Supply (Optional):** 2U Single up to 650W or 2U Redundant up to 500W ATX P/S (Rear Installation) Max. Depth 300mm
- **Cooling:** 3x (92mm = 51CFM ea.) & 1x (60mm = 23.5CFM ea.) Fans
- **Front Door:** Single Door With 1 Thumb Twist Keylock
- **Air Filter:** Inside Front Door (Washable)
- **Expansion Slots:** 7 slot Full Length
- **Thermal Management Card:** GHA-CO01
- **Indicators:** LEDs for Power ON/OFF, HDD Activity, Fan, Temperature, Buzzer Reset
- **Switch:** Power ON/OFF Momentary (Rocker), System Reset
- **Dimensions (W x H x D):** 483 x 133 x 650mm (19" x 5.2" x 25.6")
- **Cuft:** 5.3
- **GW:** 13.0kgs / 39.7lbs
- **Carton Size(cm):** 59.4 x 31.0 x 81.8 (23.4" x 12.2" x 32.2")
- **Humidity:** 5% - 95% Non-condensing

Dimension

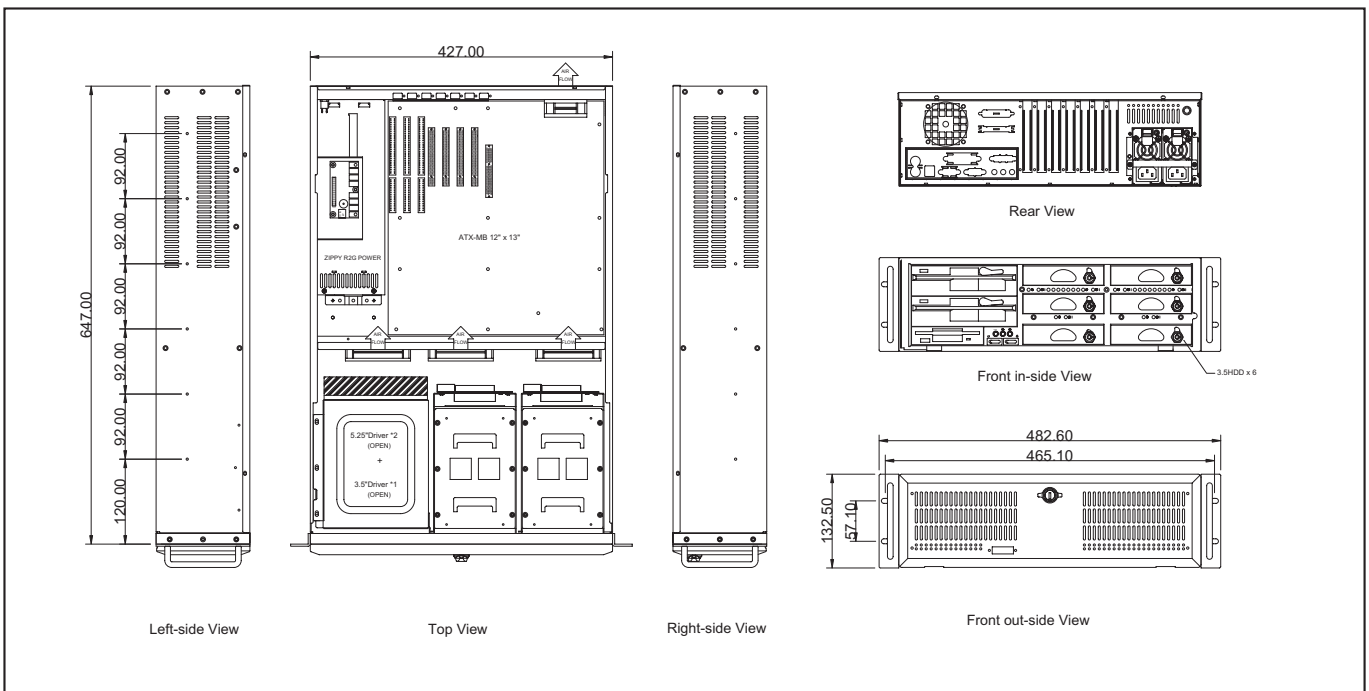

GHI-350

3U Rackmount Chassis



Specifications

- **EIA RS-310C 19" Rackmount Standard**
- **Construction:** Heavy Duty Cold Rolled Electroplated Steel
- **Color:** Black (Standard), Beige or Custom
- **System Boards:** Pentium 4, Dual Xeon, Athlon 64
- **Support ATX M/B (Max. to 12" x 9.6")**
- **Drive Capacity:** 1x 5.25" & 2x 3.5" HDD
- **Power Supply(Optional):** 2U Single 300~460W ATX P/S
Max. Depth 270mm
- **Cooling:** 2x (80mm = 42.5CFM ea.) & 2x (40mm = 7CFM ea.) Fans & 1x (60mm 23.5CFM ea.) Fan (Optional)
- **Expansion Slots:** 7 slot
- **Indicators:** LEDs for Power ON/OFF, HDD Activity, LAN
- **Switch:** Power ON/OFF, System Reset on Rear Side
- **Dimensions (WxHxD):** 483x133x400mm (19" x 5.2" x 15.7")
- **Cuft:** 3.5
- **GW:** 12.5kgs / 27.5lbs
- **Carton Size(cm):** 58.0 x 28.5 x 59.9 (22.8" x 11.2" x 23.6")
- **Humidity:** 5% - 95% Non-condensing

Dimension

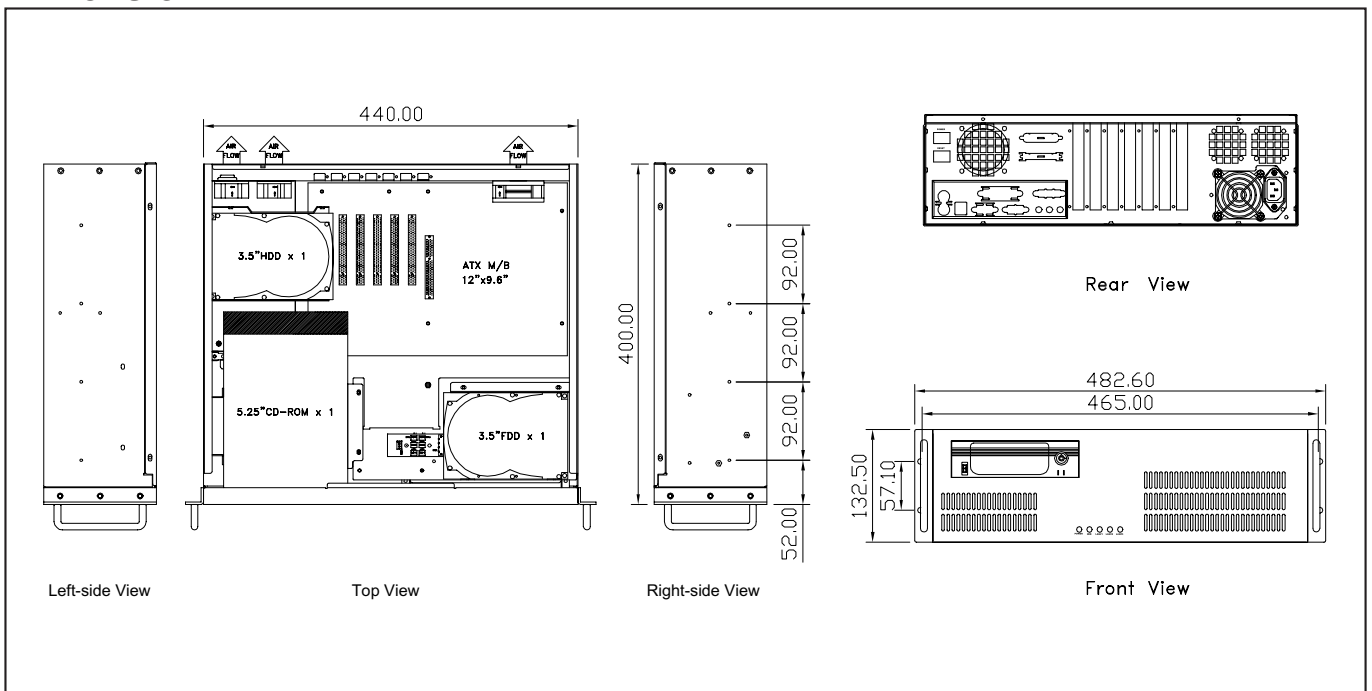

GHI-360

3U Rackmount Chassis



Specifications

- **EIA RS-310C 19" Rackmount Standard**
- **Construction:** Heavy Duty Cold Rolled Electroplated Steel
- **Color:** Black (Standard), Beige or Custom
- **System Boards:** Pentium 4, Dual Xeon, Athlon 64, Dual Opteron
- **Support EATX M/B (Max. to 12" x 13") SSI EEB 3.0**
- **Drive Capacity:** 26x Hot Swap 2.5" Drive Tray & 1x 5.25" CD-ROM
- **Drive Interface:** SATA, SCSI320, SAS
- **Power Supply:** 2U Single up to 650W or 2U Redundant up to 500W ATX P/S (Rear Installation) Max. Depth 300mm
- **Cooling:** 4x (92mm = 51CFM ea.) & 1x (60mm = 23.5CFM ea.) & 2x (40mm = 15.3CFM ea.) Fans
- **Front Door:** Single Door With 2 Thumbscrews (Removable)
- **Riser Card:** GHP-R0301 (32bit Ribbon) or GHP-R0304 (64bit Ribbon) (Optional)
- **Connector Port (Front):** 2x USB Ports
- **Thermal Management Card:** GHA-CO04
- **Indicators:** LEDs for Power ON/OFF, HDD Power/Access, Fan, Temperature
- **Switch:** Power ON/OFF Momentary (Pushbutton), System Reset, Buzzer Reset
- **Dimensions (W x H x D):** 483 x 133 x 650mm (19" x 5.2" x 25.6")
- **Cuft:** 5.3
- **GW:** 20.9 kgs / 46.1 lbs
- **Carton Size(cm):** 59.4 x 31 x 81.8 (32.2" x 12.2" x 23.4")
- **Humidity:** 5% - 95% Non-condensing

Dimension

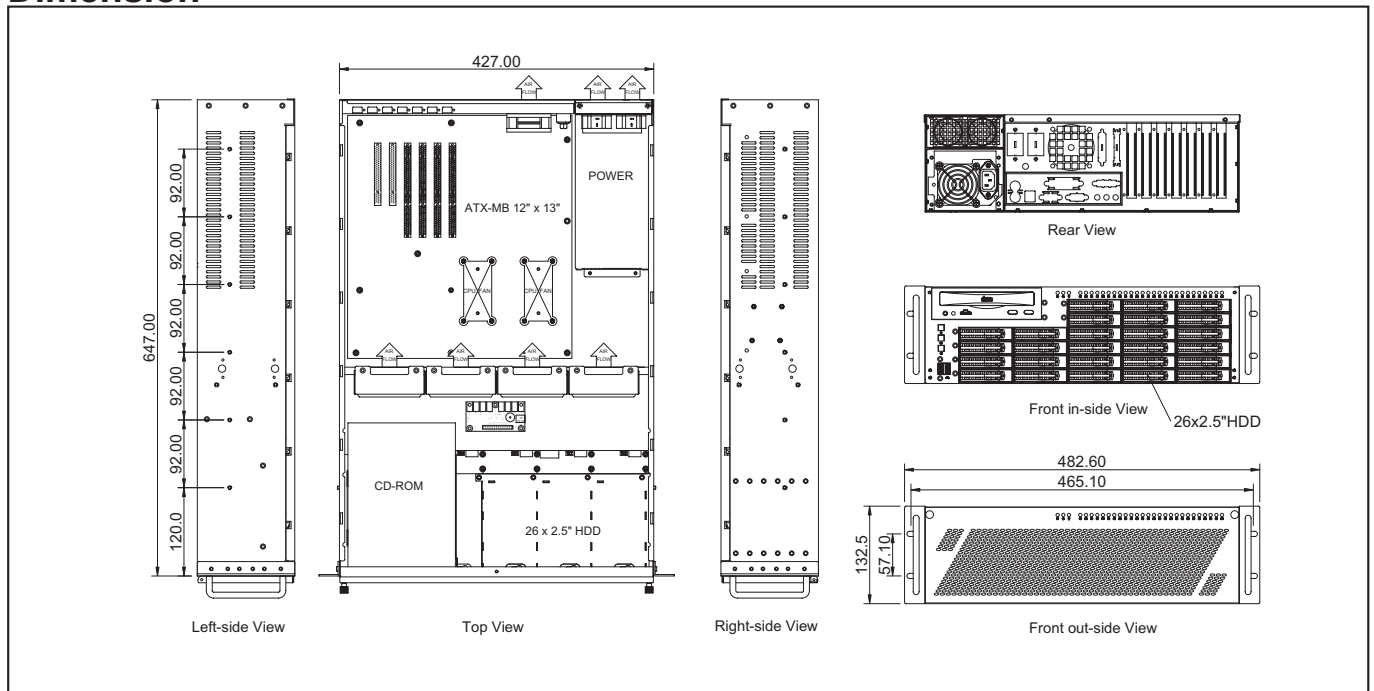

GHI-380

3U Rackmount Chassis

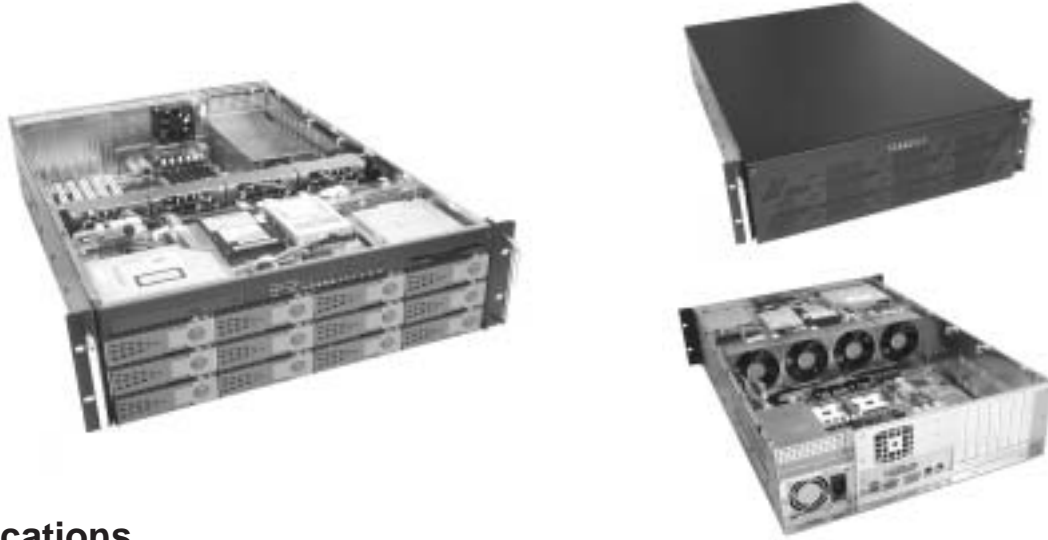

Specifications

- **EIA RS-310C 19" Rackmount Standard**
- **Construction:** Heavy Duty Cold Rolled Electroplated Steel
- **Color:** Black (Standard), Beige or Custom
- **System Boards:** Pentium 4, Dual Xeon, Athlon 64, Dual Opteron
- **Support EATX M/B (Max. to 12" x 13") SSI EEB 3.0**
- **Drive Capacity:** 1xSlim CD-ROM & 1xSlim FDD & 12x 3.5" Swappable Trays & 2x 2.5HDD & 2x 3.5"HDD (Optional)
- **Drive Interface:** PATA, SATA, SCSI320, Multilane SATA or SAS
- **Power Supply(Optional):** 2U Single up to 650W or 2U Redundant up to 500W or 3U Single up to 950W ATX P/S or 3U Redundant up to 650W ATX P/S (Rear Installation) Max. Depth 300mm
- **Cooling:** 4x (92mm = 51CFM ea.) & 1x (60mm = 23.5CFM ea.) Fan
- **Front Door:** Single Door with 2 Thumbscrews(Removable)
- **Connector Port (Front):** 2x USB Ports
- **Expansion Slots:** 7 slot full length
- **Thermal Management Card:** GHA-CO04
- **Indicators:** LEDs for Power ON/OFF , HDD Activity, Fan, Temperature, LAN
- **Switch:** Power ON/OFF Momentary (Pushbutton), System Reset, Buzzer Reset
- **Dimensions (WxHxD):** 483x133x650mm(19" x 5.2" x 25.6")
- **Cuft:** 5.3
- **GW:** 22.0kgs / 48.5lbs
- **Carton Size(cm):** 81.8 x 31.0 x 59.4 (32.2" x 12.2" x 23.4")
- **Humidity:** 5% - 95% Non-condensing

Dimension

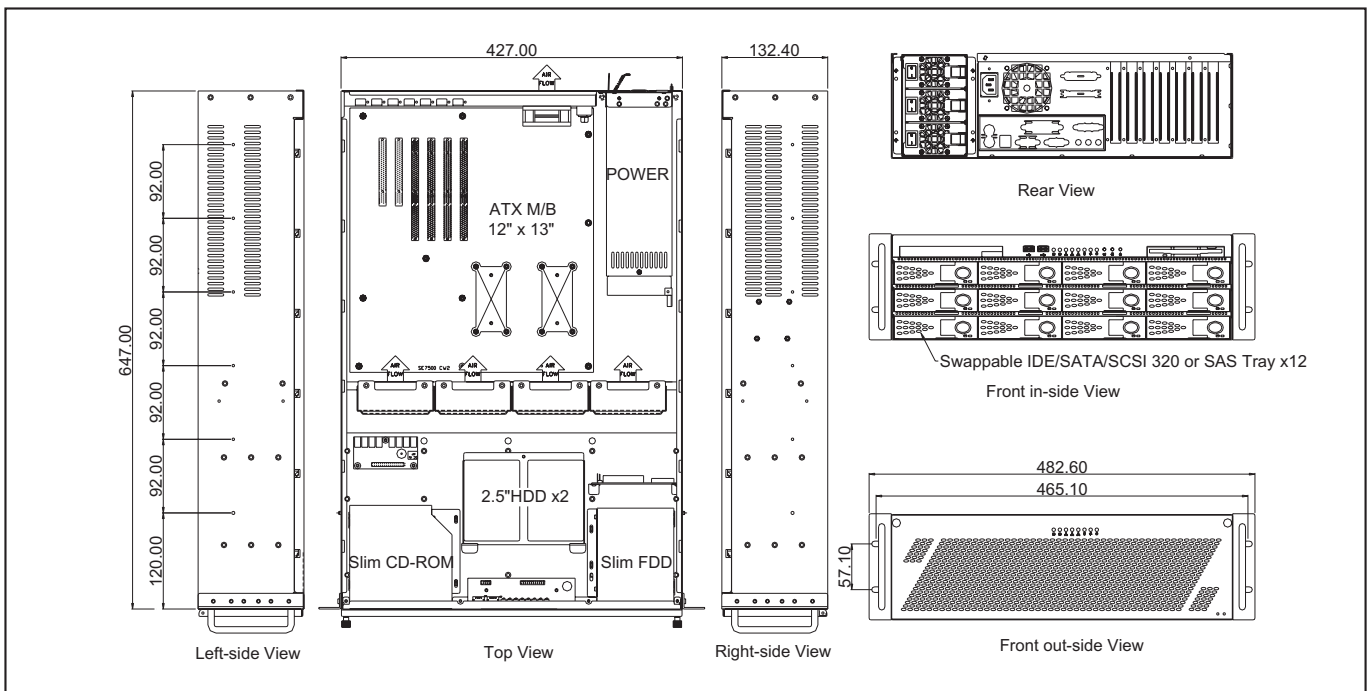

GHI-381

3U Rackmount Chassis



Specifications

- **EIA RS-310C 19" Rackmount Standard**
- **Construction:** Heavy Duty Cold Rolled Electroplated Steel
- **Color:** Black (Standard), Beige or Custom
- **System Boards:** Dual Xeon, Dual Opteron, Pentium 4, Dual Pentium III
- **Support EATX M/B(Max. to 12"x13")SSI EEB 3.0**
- **Drive Capacity:** 1x 5.25" & 1x Slim CD-ROM & 1x Slim FDD & 10x 3.5" Swappable Trays
- **Drive Interface:** PATA, SATA, SCSI320, Multilane SATA or SAS
- **Power Supply(Optional):** 2U Single up to 650W or 2U Redundant up to 500W or 3U Single up to 950W ATX P/S or 3U Redundant up to 650W ATX P/S (Rear Installation) Max. Depth 300mm
- **Cooling:** 4x (92cm = 51CFM ea.) & 1x (60mm = 23.5CFM ea.) Fan
- **Front Door:** Single Door with 2 Thumbscrews(Removable)
- **Connector Port (Front):** 2x USB Ports
- **Expansion Slots:** 7 slot full length
- **Thermal Management Card:** GHA-CO04
- **Indicators:** LEDs for Power ON/OFF, HDD Activity, Fan, Temperature, LAN
- **Switch:** Power ON/OFF Momentary (Pushbutton), System Reset, Buzzer Reset
- **Dimensions (WxHxD):** 483x133x650mm(19" x 5.2" x 25.6")
- **Cuft:** 5.3
- **GW:** 22.0kgs / 48.5lbs
- **Carton Size(cm):** 81.8 x 31.0 x 59.4 (32.2" x 12.2" x 23.4")
- **Humidity:** 5% - 95% Non-condensing

Dimension

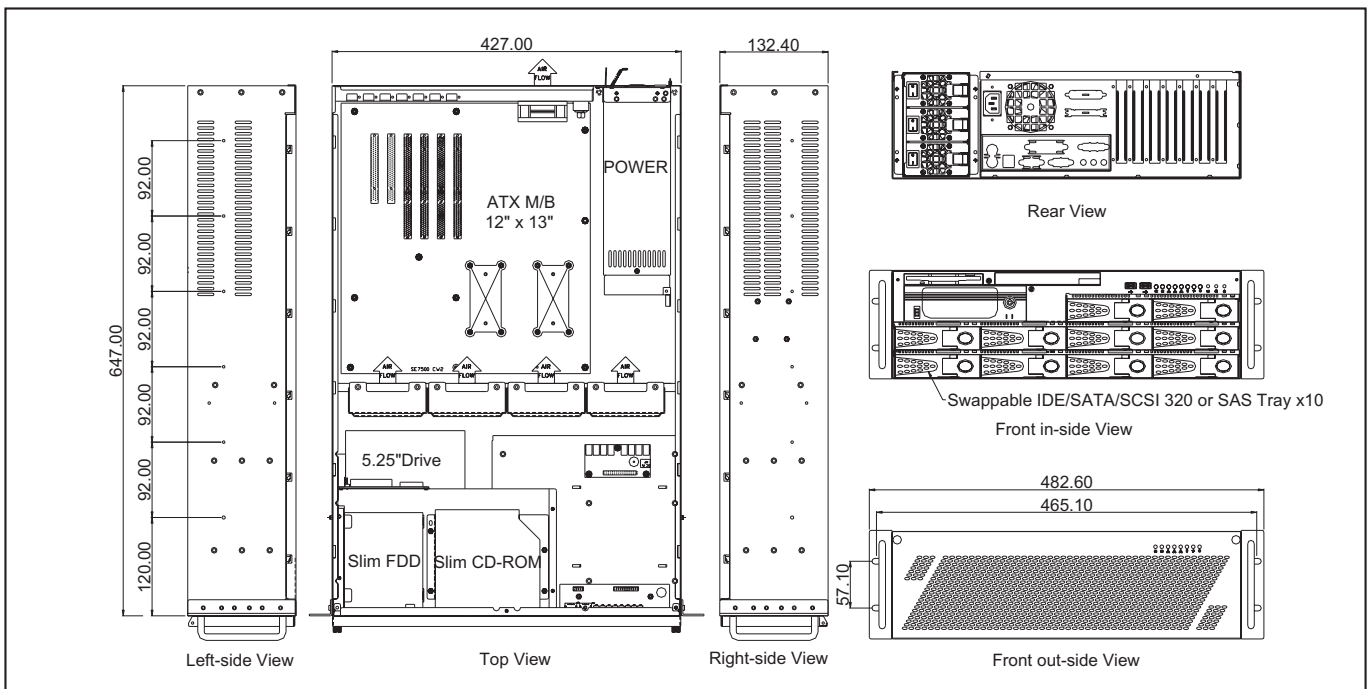

GHI-390

3U Rackmount Chassis



19" Rackmount

Specifications

- **EIA RS-310C 19" Rackmount Standard**
- **Construction:** Heavy Duty Cold Rolled Electroplated Steel
- **Color:** Black (Standard), Beige or Custom
- **System Boards:** Pentium 4, Dual Xeon, Athlon 64, Dual Opteron
- **Support EATX M/B (Max. to 12" x 13") SSI EEB 3.0**
- **Drive Capacity:** 1x Slim CD-ROM & 16x 3.5" Swappable Trays
- **Drive Interface:** SATA, SCSI320, Multilane SATA or SAS
- **Power Supply(Optional):** 2U Single up to 650W or 2U Redundant up to 500W or 3U Single up to 950W ATX P/S or 3U Redundant up to 650W ATX P/S (Rear Installation) Max. Depth 300mm
- **Cooling:** 4x(92mm = 51CFM ea) & 1x (60mm = 23.5CFM ea.) Fan
- **Front Door:** Single Door with 2 Thumbscrews (Removable)
- **Connector Port (Front):** 2x USB Ports
- **Expansion Slots:** 7 Slot Full Length
- **Thermal Management Card:** GHA-CO04
- **Indicators:** LEDs for Power ON/OFF , HDD Activity, Fans, Temperature, LAN
- **Switch:** Power ON/OFF Momentary (Pushbutton), System Reset, Buzzer Reset
- **Dimensions (WxHxD):** 483x133x650mm (19" x 5.2" x 25.6")
- **Cuft:** 5.3
- **GW:** 22.0kgs / 48.5lbs
- **Carton Size(cm):** 81.8 x 31.0 x 59.4 (32.2" x 12.2" x 23.4")
- **Humidity:** 5% - 95% Non-condensing

Dimension

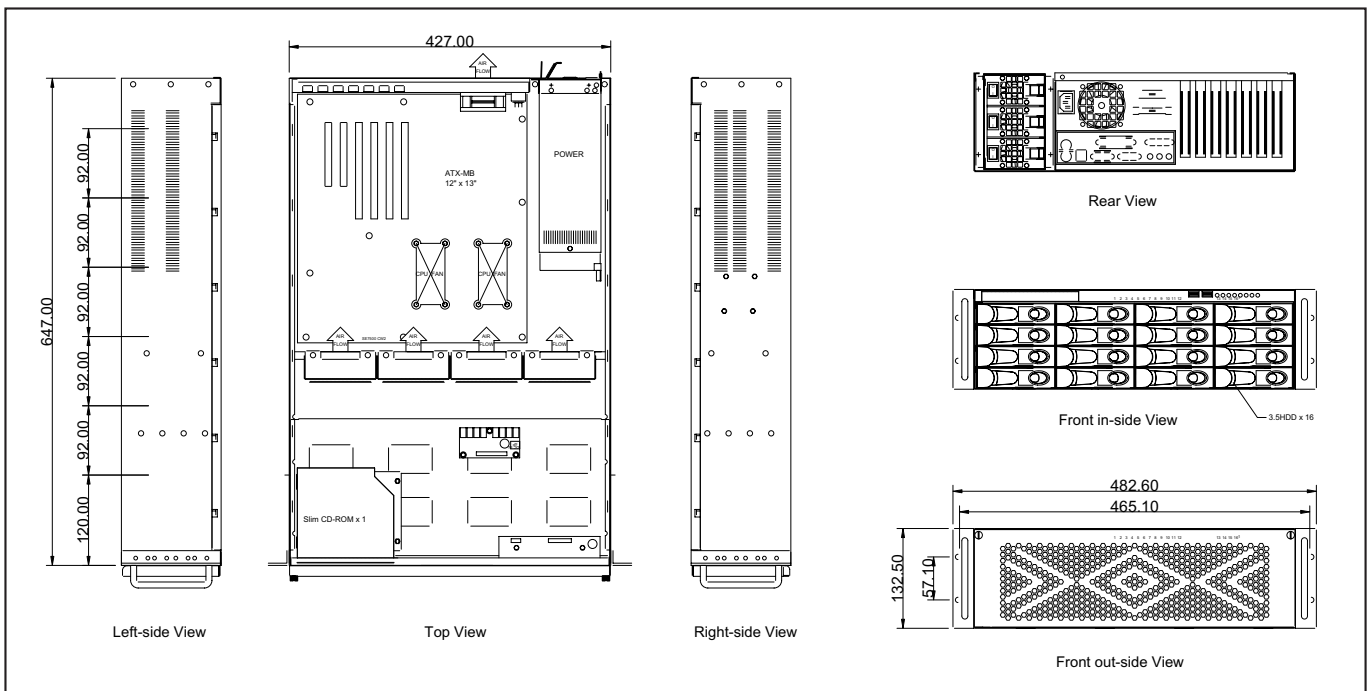

GH-400ATX/400S

4U Rackmount Chassis



Specifications

- **EIA RS-310C 19" Rackmount Standard**
- **Construction:** Heavy Duty Cold Rolled Electroplated Steel
- **Color:** Black (Standard), Beige or Custom
- **System Boards:** Pentium 4, Dual Xeon, Athlon 64, Dual Opteron
- **Support ATX M/B (Max. to 12" x 9.6") (400ATX)**
- **Support 14-slot Passive Backplane (400S)**
- **Drive Capacity:** 2x 5.25" & 1x 3.5" & 1x 3.5" HDD
- **Power Supply (Optional):** PS/2 Size Single up to 700W ATX P/S (Rear Installation) Max. Depth 200mm
- **Cooling:** 2x (80mm = 42.5CFM ea.) Fans
- **Front Door:** Drive Panel Door with Keylock
- **Air Filter:** Inside Front Panel (Washable)
- **Connector Port (Front):** 1xPS/2 for GH-400S & 2x USB (Optional) Ports
- **Expansion Slots:** 7 slot (400ATX) or 14 Slot (400S)
- **Indicators:** LED for Power ON/OFF, HDD Activity
- **Flexible Hold Down Bar Designed**
- **Switch:** Power ON/OFF Momentary (Pushbutton), System Reset
- **Dimensions (WxHxD):** 483x177x439mm (19" x 7.0" x 17.3")
- **Cuft:** 4.4
- **GW:** 16.0kgs / 35.2lbs
- **Carton Size(cm):** 61.8 x 34 x 59 (24.3" x 13.4" x 23.2")
- **Humidity:** 5% - 95% Non-condensing

Dimension

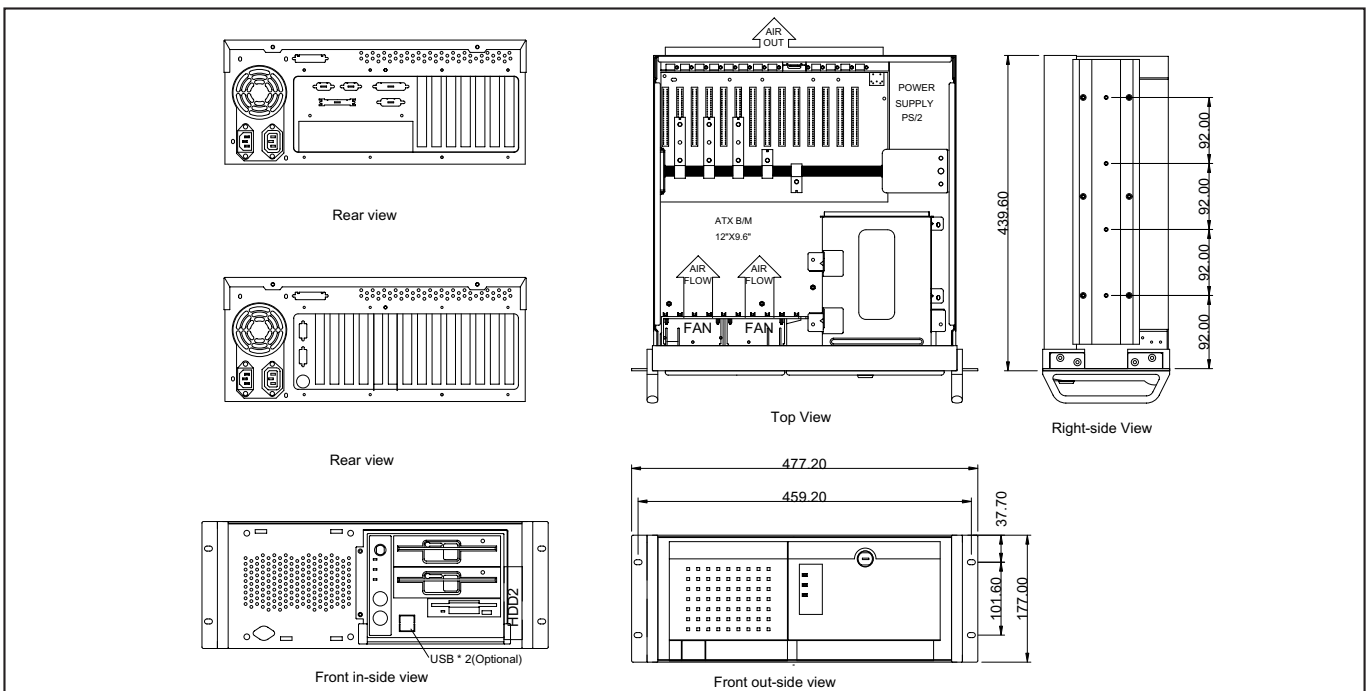

GH-402ATXR/402SR

4U Rackmount Chassis



19" Rackmount

Specifications

- **EIA RS-310C 19" Rackmount Standard**
- **Construction:** Heavy Duty Cold Rolled Electroplated Steel
- **Color:** Black (Standard), Beige or Custom
- **System Boards:** Pentium 4, Dual Xeon, Athlon 64, Dual Opteron
- **Support ATX M/B (Max. to 12" x 9.6") (402ATXR)**
- **Support 14/15-slot Passive Backplane (402SR)**
- **Drive Capacity:** 3x 5.25" & 1x 3.5"
- **Power Supply (Optional):** PS/2 Size Single up to 700W or Mini Redundant up to 500W ATX P/S(Rear Installation) Max. Depth 200mm
- **Cooling:** 2x (92mm = 51CFM ea.) Hot Swap Fans
- **Front Door:** Drive Panel Door With Keylock
- **Air Filter:** Inside Front Panel (Washable)
- **Connector Port (Front):** 1xPS/2 for GH-402SR & 2x USB (Optional) Ports
- **Indicators:** LEDs for Power ON/OFF, HDD Activity
- **Switch:** Power ON/OFF, Momentary(Pushbutton),System Reset
- **Flexible Hold Down Bar Designed**
- **Dimensions (WxHxD):** 483x177x451mm (19" x 7.0" x 17.8")
- **Cuft:** 4.4
- **GW:** 17.0kgs / 37.5lbs
- **Carton Size(cm):** 61.8 x 34.0 x 59.0 (24.3" x 13.4" x 23.2")
- **Humidity:** 5% - 95% Non-condensing

Dimension

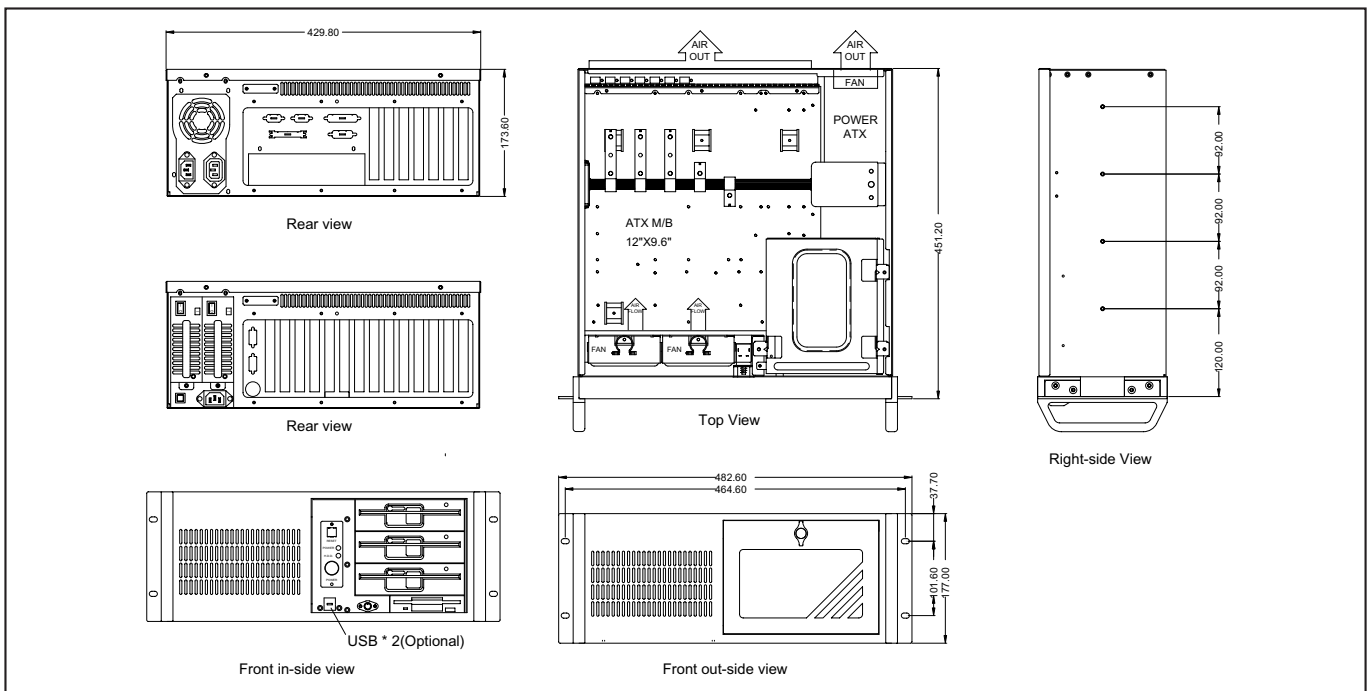

GHI-403ATXR/403SR

4U Rackmount Chassis



Specifications

- **EIA RS-310C 19" Rackmount Standard**
- **Construction:** Heavy Duty Cold Rolled Electroplated Steel
- **Color:** Black (Standard), Beige or Custom
- **System Boards:** Pentium 4, Dual Xeon, Athlon 64, Dual Opteron
- **Support ATX M/B (Max. to 12" x 9.6") (403ATXR)**
- **Support 14/15-slot Passive Backplane (403SR)**
- **Drive Capacity:** 3x 5.25" & 1x 3.5"
- **Power Supply (Optional):** PS/2 Size Single up to 700W ATX or Mini Redundant up to 500W ATX P/S (Rear Installation) Max. Depth 200mm
- **Cooling:** 2x (92mm = 51CFM ea.) Hot Swap Fans
- **Front Door:** Single Door with 1 Thumb Twist keylock
- **Air Filter:** Inside Front Door (Washable)
- **Connector Port (Front):** 1xPS/2 for GH-403SR & 2x USB (Optional) Ports
- **Indicators:** LEDs for Power ON/OFF, HDD Activity
- **Flexible Hold Down Bar Designed**
- **Switch:** Power ON/OFF, Momentary(Pushbutton), System Reset
- **Dimensions (WxHxD):** 483x177x451mm (19.0" x 7.0" x 17.8")
- **Cuft:** 4.4
- **GW:** 17.0kgs / 37.5lbs
- **Carton Size(cm):** 61.8 x 34.0 x 59.0 (24.3" x 13.4" x 23.2")
- **Humidity:** 5% - 95% Non-condensing

Dimension

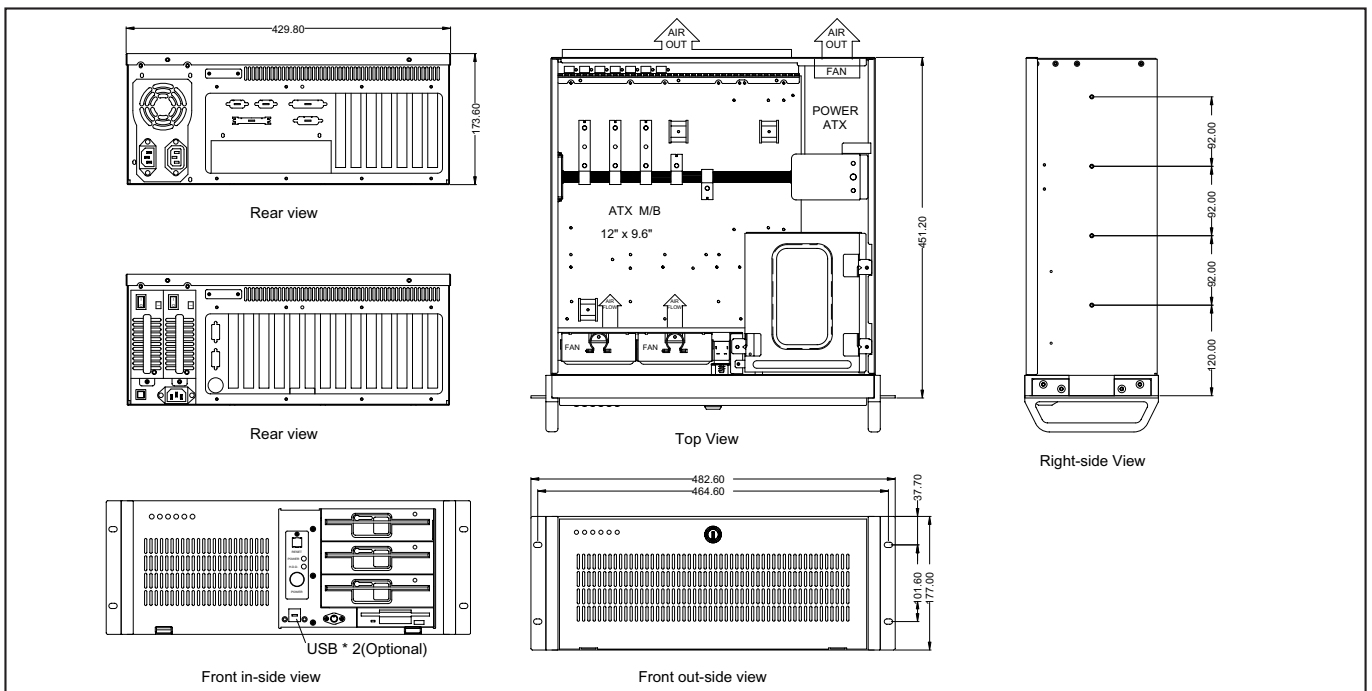

GH-410ATXR/410SR

4U Rackmount Chassis



19" Rackmount

Specifications

- **EIA RS-310C 19" Rackmount Standard**
- **Construction:** Heavy Duty Cold Rolled Electroplated Steel
- **Color:** Black (Standard), Beige or Custom
- **System Boards:** Pentium 4, Dual Xeon, Athlon 64, Dual Opteron
- **Support ATX M/B(Max. to 12" x 9.6")(410ATXR)**
- **Support 14/15-slot Passive Backplane (410SR)**
- **Drive Capacity:** 3x 5.25" & 1x 3.5"HDD & 1x 3.5"HDD (Optional)
- **Power Supply (Optional):** PS/2 Size Single up to 700W or Mini Redundant up to 500W ATX P/S (Rear Installation) Max. Depth 200mm
- **Front Door:** Drive Panel Door With Keylock
- **Connector Port (Front):** 1xPS/2 Port for GH-410SR
- **Air Filter:** Inside Front Panel (Washable)
- **Cooling:** 1x (120mm = 108CFM ea.) Fan, (One Optional Opening for Extra 120mm Fan)
- **Indicators:** LEDs for Power ON/OFF, HDD Activity
- **Flexible Hold Down Bar Designed**
- **Switch:** Power ON/OFF Momentary (Pushbutton), System Reset
- **Dimensions (WxHxD):** 483x177x510mm (19" x 7.0" x 20.1")
- **Cuft:** 4.9
- **GW:** 18.0kgs / 39.7lbs
- **Carton Size(cm):** 59.1 x 34.0 x 68.8 (23.3" x 13.4" x 27.1")
- **Humidity:** 5% - 95% Non-condensing

Dimension

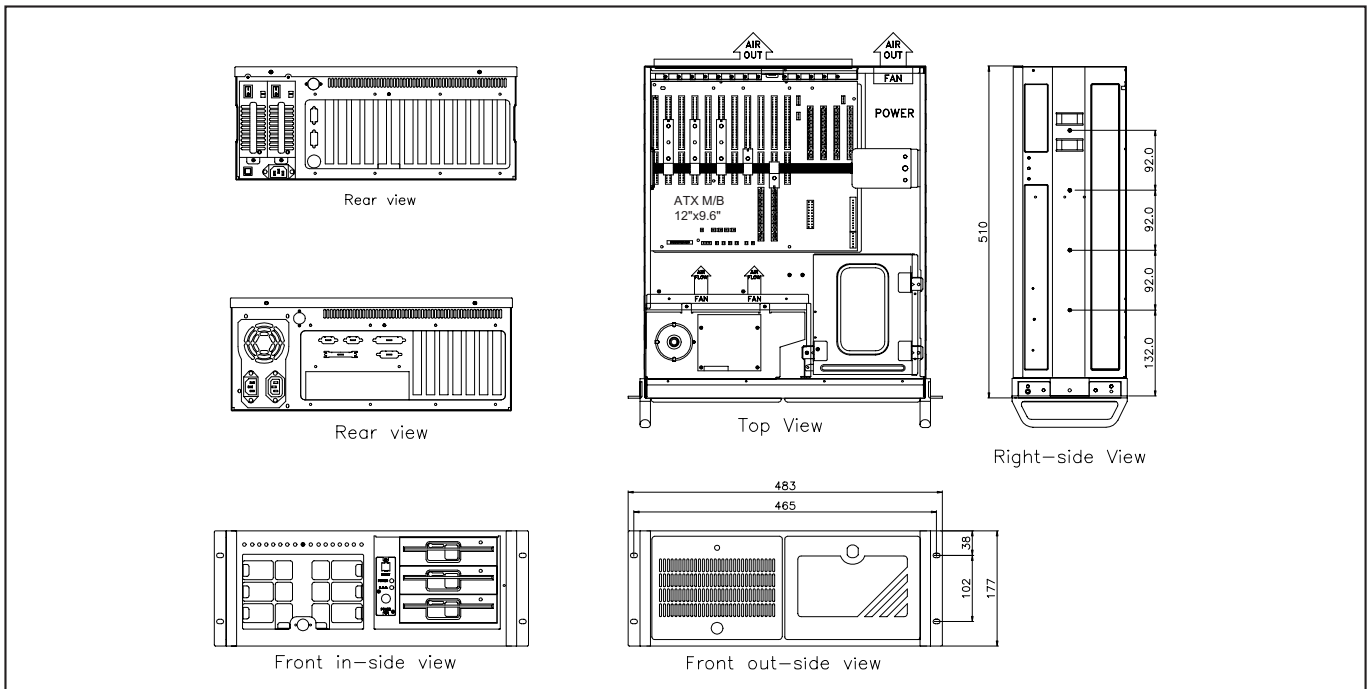

GH-411ATXR/411SR

4U Rackmount Chassis



Specifications

- **EIA RS-310C 19" Rackmount Standard**
- **Construction:** Heavy Duty Cold Rolled Electroplated Steel
- **Color:** Black (Standard), Beige or Custom
- **System Boards:** Pentium 4, Dual Xeon, Athlon 64, Dual Opteron
- **Support ATX M/B (Max. to 12" x 9.6") (411ATXR)**
- **Support 14/15-slot Passive Backplane(411SR)**
- **Drive Capacity:** 4x 5.25" & 1x 3.5"(Vertical) & 1x 3.5"HDD (Optional)
- **Power Supply(Optional):** PS/2 Size Single up tp 700W or Redundant up to 500W ATX P/S (Rear Installation) Max. Depth 200mm
- **Connector Port (Front):** 1 x PS/2 Port for GH-411SR & 2 x USB(Optional) Ports
- **Cooling:** 1x (120mm = 108CFM ea.) Fan
- **Front Door:** Single Door with 1 Thumb Twist Keylock
- **Air Filter:** Inside Front Door (Washable)
- **Indicators:** LEDs for Power ON/OFF, HDD Activity
- **Flexible Hold Down Bar Designed**
- **Switch:** Power ON/OFF Momentary (Pushbutton), System Reset
- **Dimensions(WxHxD):** 483x177x510mm(19" x 7.0" x 20.1")
- **Cuft:** 4.9
- **GW:** 18.0kgs / 39.7lbs
- **Carton Size(cm):** 59.1 x 34.0 x 68.8 (23.3" x 13.4" x 27.1")
- **Humidity:** 5% - 95% Non-condensing

Dimension

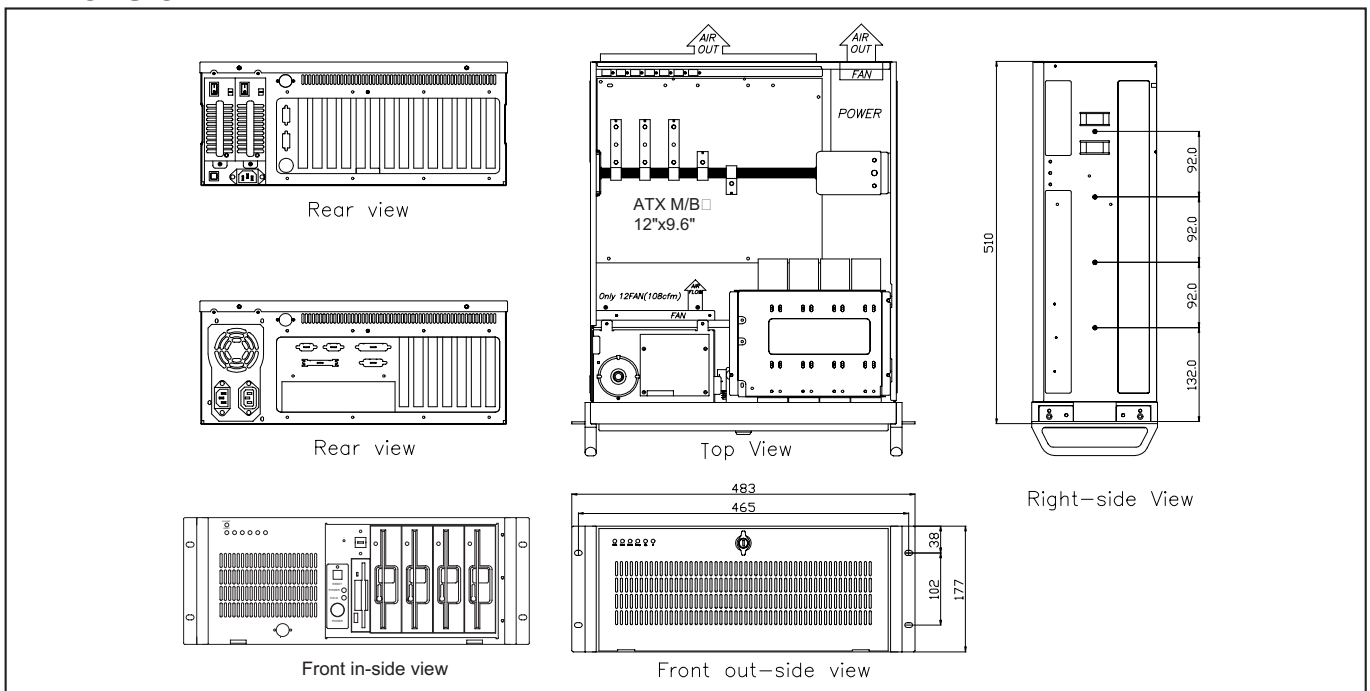

GH-414ATXR/414SR

4U Rackmount Chassis



19" Rackmount

Specifications

- **EIA RS-310C 19" Rackmount Standard**
- **Construction:** Heavy Duty Cold Rolled Electroplated Steel
- **Color:** Black (Standard), Beige or Custom
- **System Boards:** Pentium 4, Dual Xeon, Athlon 64, Dual Opteron
- **Support ATX M/B (Max. to 12"x9.6") (414ATXR)**
- **Support 14/15-slot Passive Backplane (414SR)**
- **Drive Capacity:** 3x5.25" & 1x3.5" & 1x3.5" HDD (Optional)
- **Power Supply (Optional):** PS/2 Size Single up to 700W or Mini Redundant up to 500W ATX P/S (Rear Installation) Max. Depth 220mm
- **Cooling:** 1x (120mm = 108CFM ea.) Fan (One Optional Opening for Extra 120mm Fan)
- **Front Door:** Double Panel Door With Keylock and Thumbscrew
- **Air Filter:** Inside Front Door (Washable)
- **Connector Port (Front):** 1xPS/2 for GH-414SR & 2x USB (Optional) Ports
- **Indicators:** LEDs for Power ON/OFF, HDD Activity
- **Flexible Hold Down Bar Designed**
- **Switch:** Power ON/OFF Momentary (Pushbutton), System Reset
- **Dimensions (WxHxD):** 483x177x510mm (19"x7.0"x20.1")
- **Cuft:** 4.9
- **GW:** 18.0kgs / 39.7lbs
- **Carton Size (cm):** 59.1x34.0x68.8 (23.3"x13.4"x27.1")
- **Humidity:** 5% - 95% Non-condensing

Dimension

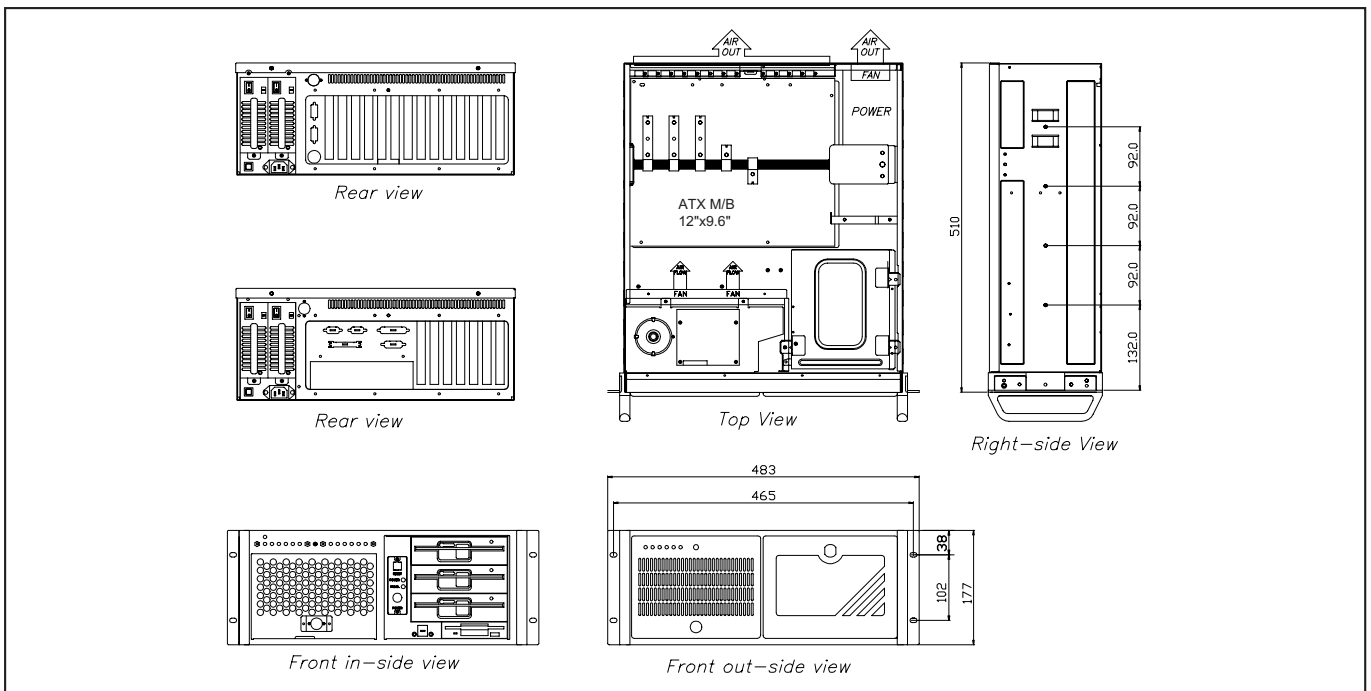

GHI-415

4U Rackmount Chassis



Specifications

- **EIA RS-310C 19" Rackmount Standard**
- **Construction:** Heavy Duty Cold Rolled Electroplated Steel
- **Color:** Black (Standard), Beige or Custom
- **System Boards:** Pentium 4, Athlon 64, Dual Xeon, Dual Opteron
- **Support ATX M/B (Max. to 12" x 13")**
- **Drive Capacity:** 5.25" Slim CD-ROM & 1x 3.5"HDD
- **Power Supply (Optional):** PS/2 Size Single up to 700W or Mini Redundant up to 500W ATX P/S (Rear Installation) Max. Depth 220mm
- **Cooling:** 3x (92 mm = 120.2CFM ea.) Fans & 2x(6cm) Fans(23.5CFM ea.)(Optional with ATX M/B)
- **Connector Port (Front):** 2x USB Ports
- **Keyboard:** 83/84 Key With Integrated Track Ball+2 Mouse Buttons
- **Air Filter:** Inside Front Panel (Washable)
- **LCD Size:** 6.4" TFT with 640*480 Resolution
- **Display Colors:** 262,144 colors
- **Indicators:** LEDs for Power ON/OFF, HDD Activity
- **Switch:** Power ON/OFF, Brightness, Contrast, Menu
- **Dimensions (W x H x D):** 483 x 177 x 490mm (19" x 7.0" x 19.3")
- **Cuft:** 4.7
- **GW:** 20kgs / 44.1lbs
- **Carton Size(cm):** 59.1 x 34.0 x 66.8 (23.3" x 13.4" x 26.3")
- **Humidity:** 5% - 95% Non-condensing

Dimension

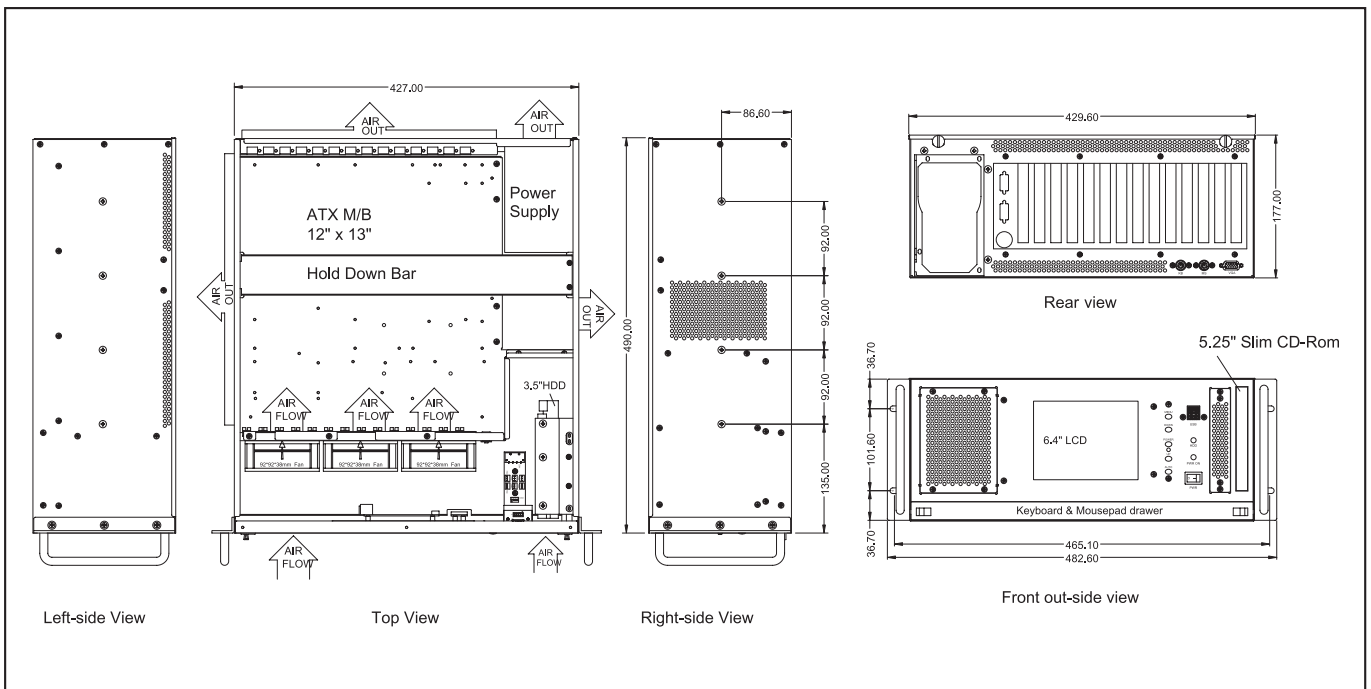

GH-416ATXR/416SR

4U Rackmount Chassis

19" Rackmount



Specifications

- **EIA RS-310C 19" Rackmount Standard**
- **Construction:** Heavy Duty Cold Rolled Electroplated Steel
- **Color:** Black (Standard), Beige or Custom
- **System Boards:** Pentium 4, Dual Xeon, Athlon 64, Dual Opteron
- **Support ATX M/B (Max. to 12" x 9.6") (416ATXR)**
- **Support 14/15-slot Passive Backplane (416SR)**
- **Drive Capacity:** 3x 5.25" & 1x 3.5" & 1x 3.5"HDD (Optional)
- **Power Supply (Optional):** PS/2 Size Single up to 700W or Mini Redundant up to 500W ATX P/S (Rear Installation) Max. Depth 220mm
- **Connector Port (Front):** 1xPS/2 for GH-416SR & 2x USB (Optional) Ports
- **Cooling:** 1x (120mm = 108CFM ea.) Fans, (One Optional Opening for Extra 120mm Fan)
- **Front Door:** Single Door with 1 Thumb Twist Keylock
- **Indicators:** LEDs for Power ON/OFF, HDD Activity
- **Flexible Hold Down Bar Designed**
- **Switch:** Power ON/OFF Momentary (Pushbutton), SystemReset
- **Dimensions(WxHxD):** 483x177x510mm(19" x 7.0" x 20.1")
- **Cuft:** 4.9
- **GW:** 18.0kgs / 39.7lbs
- **Carton Size(cm):** 59.1x34.0x68.8 (23.3" x 13.4" x 27.1")
- **Humidity:** 5% - 95% Non-condensing

Dimension

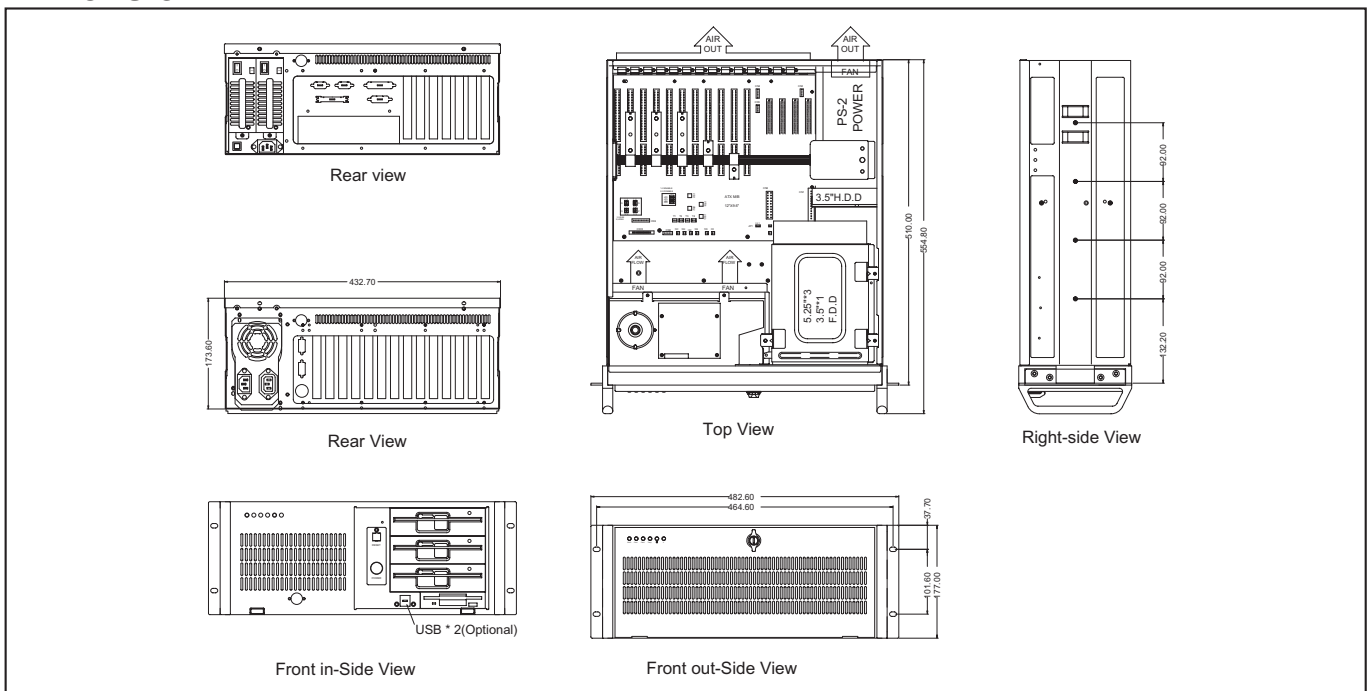

GH-418ATXR/418SR

4U Rackmount Chassis

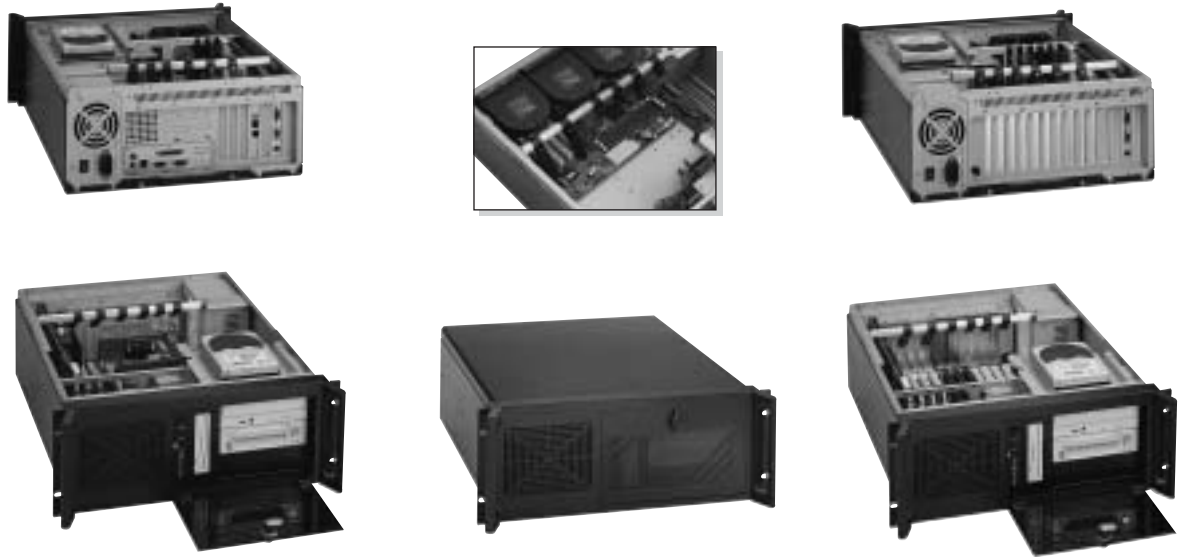

Specifications

- **EIA RS-310C 19" Rackmount Standard**
- **Construction:** Heavy Duty Cold Rolled Electroplated Steel
- **Color:** Black (Standard), Beige or Custom
- **System Boards:** Pentium 4, Dual Xeon, Athlon 64, Dual Opteron
- **Support ATX M/B (Max. to 12" x 9.6") (418ATXR)**
- **Support 14/15-slot Passive Backplane (418SR)**
- **Drive Capacity:** 3x 5.25" & 1x 3.5" & 2x 3.5" HDD
- **Power Supply (Optional):** PS/2 Size Single up to 700W or Mini Redundant up to 500W ATX P/S (Rear Installation) Max. Depth 220mm
- **Cooling:** 1x (120mm = 90CFM ea.) Fan & 3x (9cm) Blower (32CFM ea.) (Optional)
- **Front Door:** Drive Panel Door With Keylock
- **Air Filter:** Inside Front Door (Washable)
- **Indicators:** LEDs for Power, HDD Activity
- **Flexible Hold Down Bar Designed**
- **Switch:** Power ON/OFF/ON/OFF Momentary (Pushbutton), System Reset
- **Dimensions(WxHxD):** 483x177x510mm(19" x 7.0" x 20.1")
- **Cuft:** 3.8
- **GW:** 17.0kgs / 37.5lbs
- **Carton Size(cm):** 54.0 x 30.0 x 66.0 (21.3" x 11.8" x 26.0")
- **Humidity:** 5% - 95% Non-condensing

Dimension

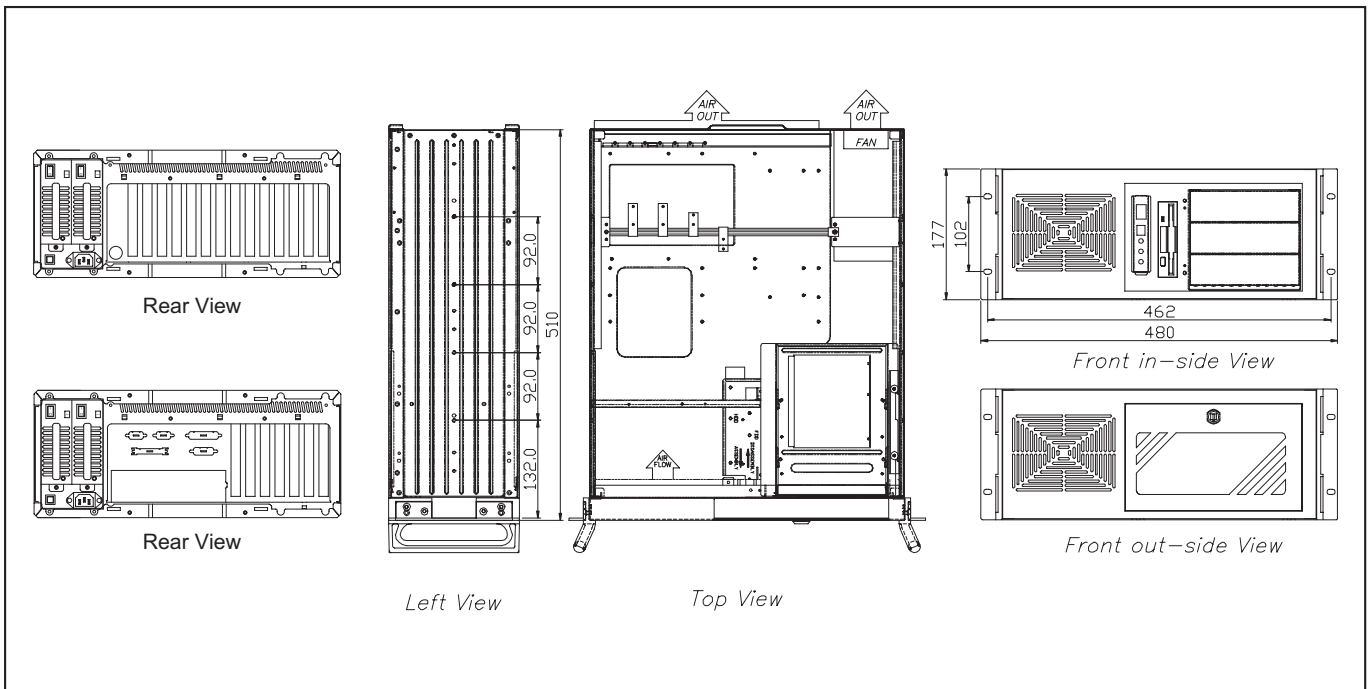

GHI-419ATXR/419SR

4U Rackmount Chassis



19" Rackmount

Specifications

- **EIA RS-310C 19" Rackmount Standard**
- **Construction:** Heavy Duty Cold Rolled Electroplated Steel
- **Color:** Black (Standard), Beige or Custom
- **System Boards:** Pentium 4, Dual Xeon, Athlon 64, Dual Opteron
- **Support EATX M/B (Max. to 12" x 13") SSI EEB 3.0**
- **Support 14/15-slot Passive Backplane (GHI-419SR)**
- **Drive Capacity:** 2x 5.25" & 1x 3.5" & 5x 3.5" HDD & 1x 3.5"HDD (Optional)
- **Power Supply (Optional):** PS/2 Size Single up to 700W or Redundant up to 500W ATX P/S(Rear Installation)Max. Depth 300mm
- **Cooling:** 2x(9cm) Fans(51CFM ea.) & 2x(6cm) Fans(23.5CFM ea.)(Optional)
- **Connector Port (Front):** 1xPS/2 for GH-419SR & 2x USB (Optional) Ports
- **Front Door:** Double Panel Door with Keylock and Thumbscrew
- **Air Filter:** Inside Front Door (Washable)
- **Indicators:** LEDs for Power ON/OFF, HDD Activity
- **Flexible Hold Down Bar Designed**
- **Switch:** Power ON/OFF Momentary (Pushbutton), System Reset
- **Dimensions(WxHxD):** 483x177x510mm(19" x 7.0" x 20.1")
- **Cuft:** 4.9
- **GW:** 19.0kgs / 41.8lbs
- **Carton Size(cm):** 68.8 x 34.0 x 59.1 (27.1" x 13.4" x 23.3")
- **Humidity:** 5% - 95% Non-condensing

Dimension

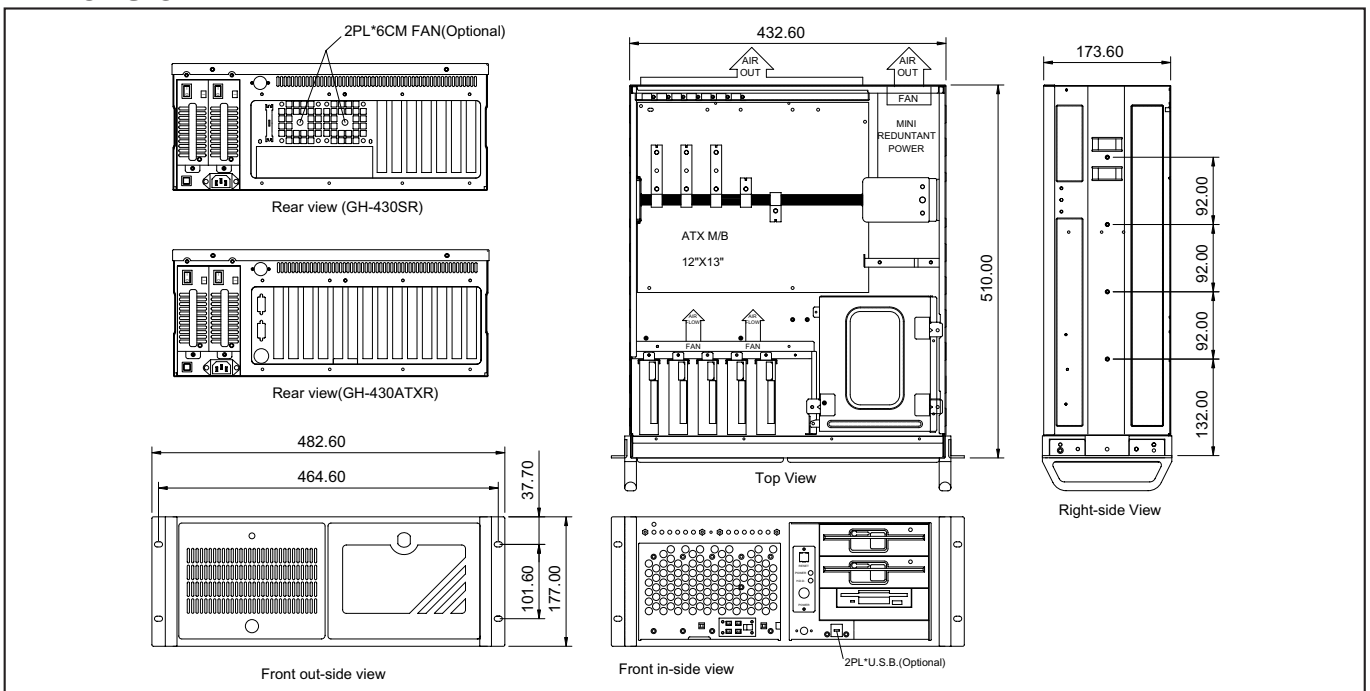

GH-430ATXR/430SR

4U Rackmount Chassis



Specifications

- **EIA RS-310C 19" Rackmount Standard**
- **Construction:** Heavy Duty Cold Rolled Electroplated Steel
- **Color:** Black (Standard), Beige or Custom
- **System Boards:** Pentium 4, Dual Xeon, Athlon 64, Dual Opteron
- **Support EATX M/B (Max. to 12" x 13")(430ATXR)**
- **Support 19-slot Passive Backplane (430SR)**
- **Drive Capacity:** 3x 5.25" & 1x 3.5" & 2x 3.5"HDD (Optional)
- **Power Supply (Optional):** Vertical Full Size Redundant P/S up to 460W ATX P/S(Front Installation)Max. Depth 200mm
- **Cooling:** Hot Swappable 4x (92mm = 51CFM ea.) Fans & 1x (80mm = 42.5CFM ea.) Fans (430ATXR-Optional)
- **Front Door:** Single Door with 1 Thumb Twist Keylock
- **Air Filter:** Inside Front Door (Washable)
- **Thermal Management Card:** GHA-CO03 (Optional)
- **Indicators:** LEDs for Power ON/OFF, HDD Activity
- **Flexible Hold Down Bar Designed**
- **Switch:** Power ON/OFF Momentary (Pushbutton), System Reset
- **Dimensions (WxHxD):** 483x177x671mm(19" x 7.0" x26.4")
- **Cuft:** 5.8
- **GW:** 21.0kgs / 46.3lbs
- **Carton Size(cm):** 85.4 x 33.6 x 57.6 (33.6" x 13.2" x 22.7")
- **Humidity:** 5% - 95% Non-condensing

Dimension

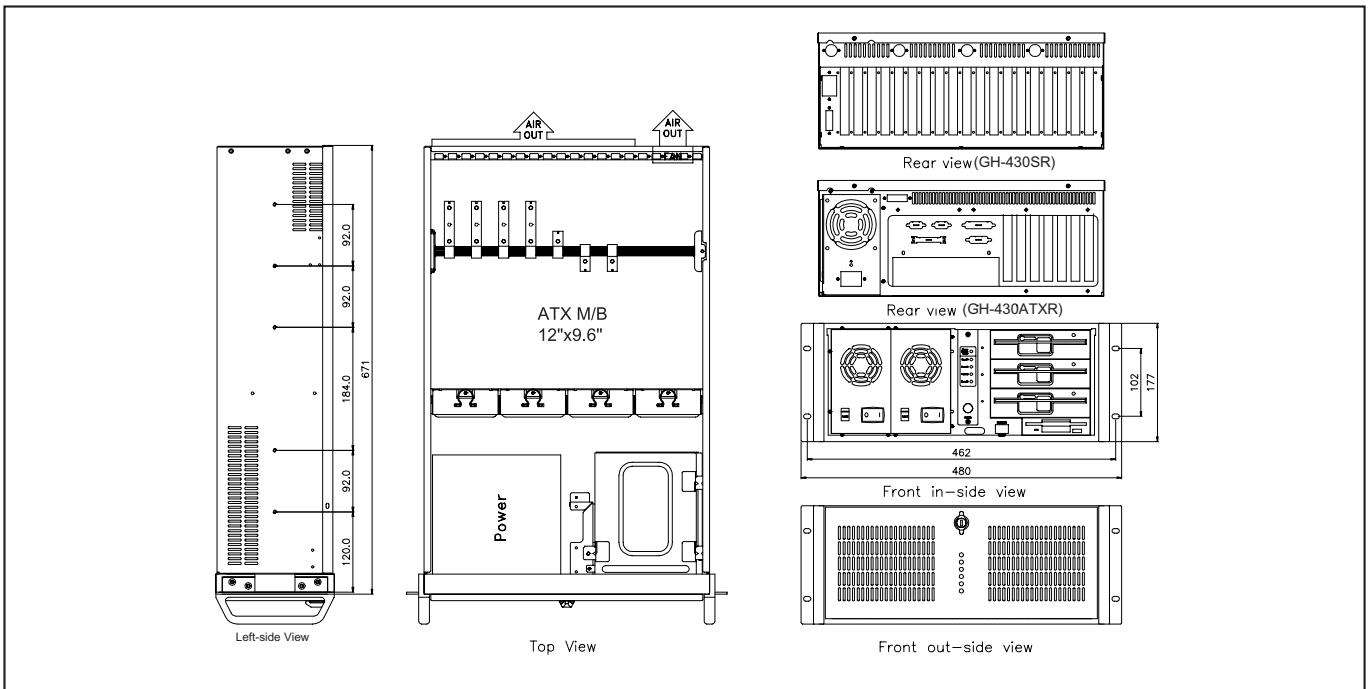

GH-431ATXR/431SR

4U Rackmount Chassis



19" Rackmount

Specifications

- **EIA RS-310C 19" Rackmount Standard**
- **Construction:** Heavy Duty Cold Rolled Electroplated Steel
- **Color:** Black (Standard), Beige or Custom
- **System Boards:** Pentium 4, Dual Xeon, Athlon 64, Dual Opteron
- **Support EATX M/B (Max. to 12" x 13") (431ATXR)**
- **Support 14/15-slot Passive Backplane (431SR)**
- **Drive Capacity:** 6x 5.25" & 1x 3.5" & 1x 3.5" HDD & 2x 3.5" HDD (Optional)
- **Power Supply (Optional):** PS/2 Size Single up to 700W or Mini Redundant up to 500W ATX P/S (Rear Installation) Max. Depth 200mm
- **Cooling:** Hot Swappable 4x (92mm = 51CFM ea.) Fans
- **Front Door:** Single Door with 1 Thumb Twist Keylock
- **Air Filter:** Inside Front Door (Washable)
- **Thermal Management Card:** GHA-CO03 (Optional)
- **Indicators:** LEDs for Power ON/OFF, HDD Activity
- **Flexible Hold Down Bar Designed**
- **Switch:** Power ON/OFF Momentary (Pushbutton), System Reset
- **Dimensions(WxHxD):** 483x177x671mm(19" x 7.0" x 26.4")
- **Cuft:** 5.8
- **GW:** 21.0kgs / 46.3lbs
- **Carton Size(cm):** 85.4 x 33.6 x 57.6 (33.6" x 13.2" x 22.7")
- **Humidity:** 5% - 95% Non-condensing

Dimension

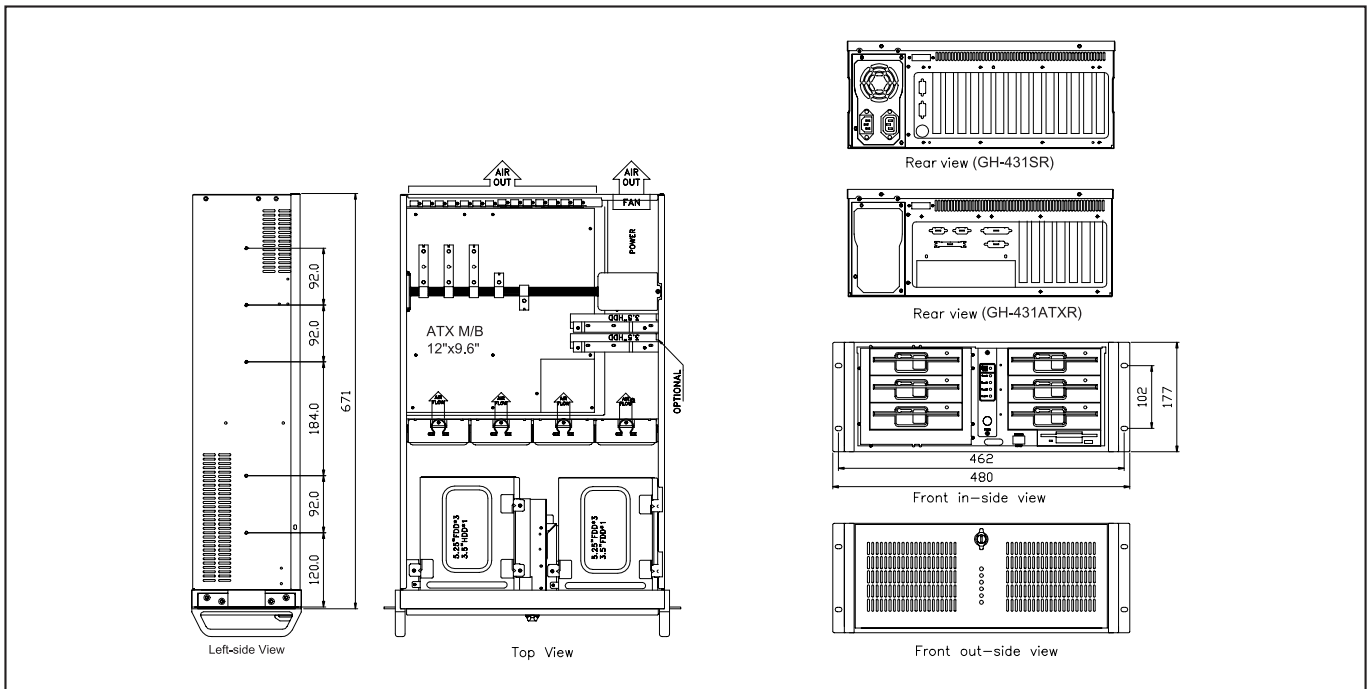

GH-432ATXR/432SR

4U Rackmount Chassis



Specifications

- **EIA RS-310C 19" Rackmount Standard**
- **Construction:** Heavy Duty Cold Rolled Electroplated Steel
- **Color:** Black (Standard), Beige or Custom
- **System Boards:** Dual Xeon, Pentium 4, Dual Pentium III
- **Support EATX M/B(Max. to 12"x13")(432ATXR)**
- **Support 19-slot Passive Backplane(432SR)**
- **Drive Capacity:** 3x 5.25" & 1x 3.5" & 2x 3.5"HDD & 2x 3.5"HDD (Optional)
- **Power Supply(Optional):** PS/2 Size Single up to 700W or Mni Redundant up to 500W ATX P/S (Front Installation) Max. Depth 200mm
- **Cooling:** Hot Swappable 4x (92mm = 51CFM ea.) Fans & 1x (80mm = 42.5CFM ea.) Fans (432ATXR-Optional)
- **Front Door:** Single Door with 1 Thumb Twist Keylock
- **Connector Port (Front):** 2x USB Ports (Optional)
- **Air Filter:** Inside Front Door (Washable)
- **Thermal Management Card:** GHA-CO03 (Optional)
- **Indicators:** LEDs for Power ON/OFF, HDD Activity
- **Flexible Hold Down Bar Designed**
- **Switch:** Power ON/OFF Momentary (Pushbutton), System Reset
- **Dimensions (WxHxD):** 483x177x671mm (19" x 7.0" x 26.4")
- **Cuft:** 5.8
- **GW:** 21.0kgs / 46.3lbs
- **Carton Size(cm):** 85.4 x 33.6 x 57.6 (33.6" x 13.2" x 22.7")
- **Humidity:** 5% - 95% Non-condensing

Dimension

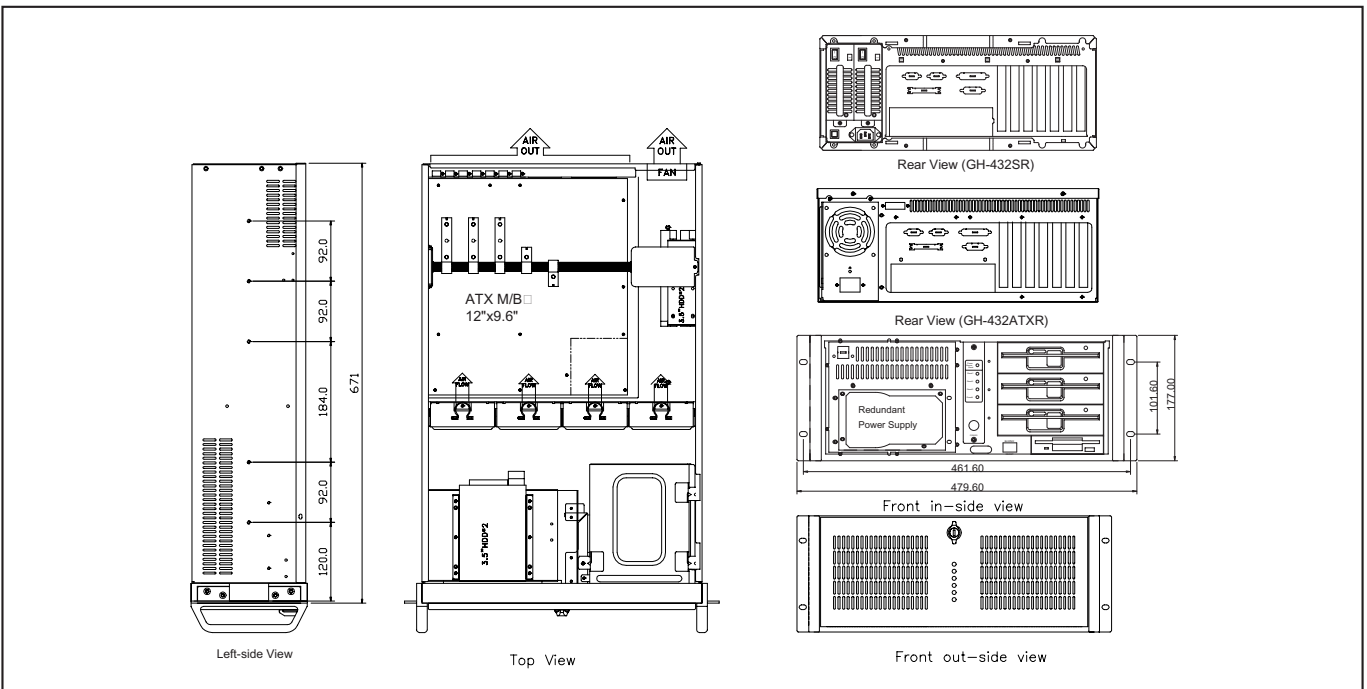

GHI-440

4U Rackmount Chassis



19" Rackmount

Specifications

- **EIA RS-310C 19" Rackmount Standard**
- **Construction:** Heavy Duty Cold Rolled Electroplated Steel
- **Color:** Black (Standard), Beige or Custom
- **System Boards:** Pentium 4, Dual Xeon, Athlon 64, Dual Opteron
- **Supports EATX M/B (Max. to 12" x 13") SSI EEB 3.0**
- **Drive Capacity:** 8x CD-ROM & 4x 3.5"HDD & 1x 3.5"FDD or 1x CD-ROM & 15x 3.5"HDD & 1x 3.5"FDD
- **Power Supply (Optional):** Single PS2 up to 700W or Mini Redundant up to 500W ATX P/S (Rear Installation) Max Depth 300mm
- **Cooling:** 3x (120mm = 90CFM ea.) Fans & 2x (60mm 23.5CFM ea.)(Optional) Fans
- **Front Door:** Single Door with 2 Thumbscrews and Removable Door
- **Connector Port (Front):** 2x USB Ports
- **Indicators:** LEDs for Power ON/OFF, HDD Activity, 2x LAN
- **Flexible Hold Down Bar Designed**
- **Switch:** Power ON/OFF Momentary (Dimple), System Reset
- **Dimensions(WxHxD):** 483x177x624mm(19" x 7.0" x 24.5")
- **Cuft:** 5.5
- **GW:** 19.5 kgs / 43.0 lbs
- **Carton Size (cm):** 80.0 x 33.1 x 59.0(31.5" x 13.0" x 23.2")
- **Humidity:** 5% - 95% Non-condensing

Dimension

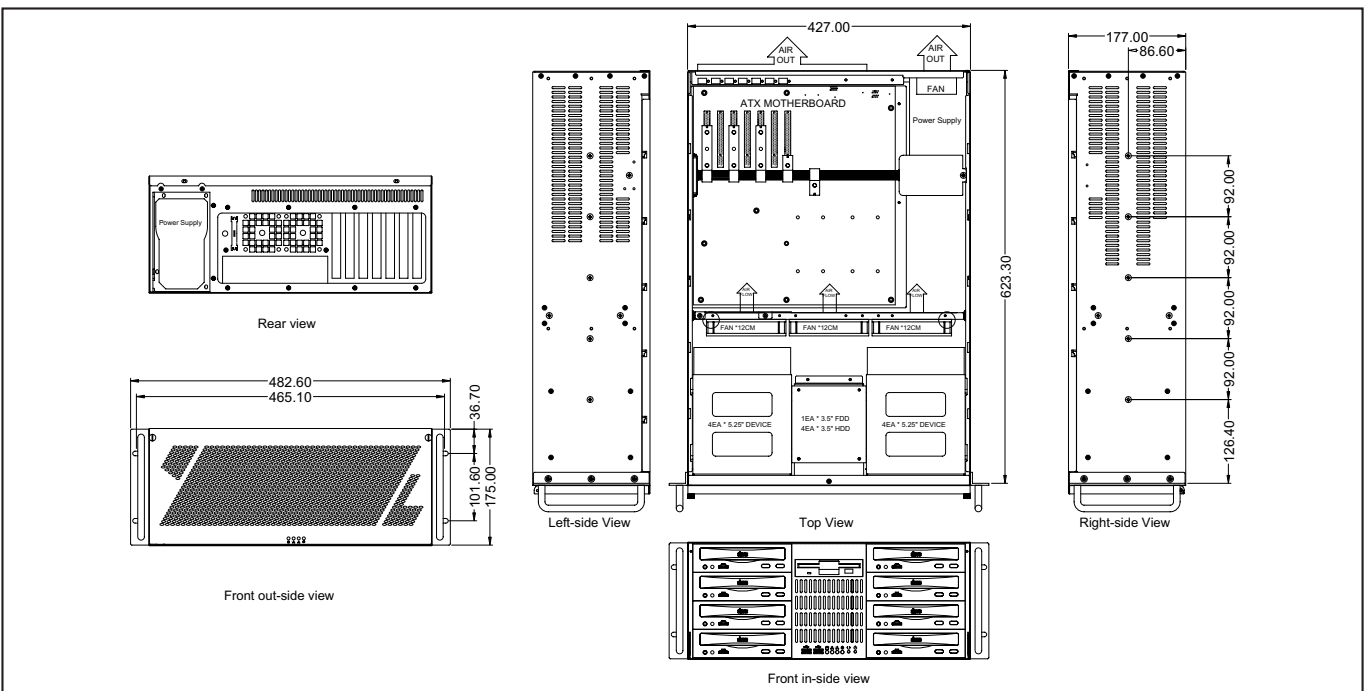

GHI-441

4U Rackmount Chassis



Specifications

- **EIA RS-310C 19" Rackmount Standard**
- **Construction:** Heavy Duty Cold Rolled Electroplated Steel
- **Color:** Black (Standard), Beige or Custom
- **System Boards:** Pentium 4, Dual Xeon, Athlon 64, Dual Opteron
- **Supports EATX M/B (Max. to 12" x 13") SSI EEB 3.0 With Removable Drawer**
- **Drive Capacity:** 8x CD-ROM & 4x 3.5"HDD & 1x 3.5"FDD or 1x CD-ROM & 15x 3.5"HDD & 1x 3.5"FDD
- **Power Supply (Optional):** Single PS2 Size up to 700W or Mini Redundant up to 500W ATX P/S (Rear Installation) Max Depth 250mm
- **Cooling:** 3x (120mm = 90CFM ea.) Fans & 2x (60mm = 23.5CFM ea.) Fans (Optional)
- **Front Door:** Single Door with 2 Thumbscrews and Removable Door
- **Connector Port (Front):** 2x USB Ports
- **Indicators:** LEDs for Power ON/OFF, HDD Activity, 2x LAN
- **Flexible Hold Down Bar Designed**
- **Switch:** Power ON/OFF Momentary (Dimple), System Reset
- **Dimensions (WxHxD):** 483x177x571mm (19"x 7.0" x22.5")
- **Cuft:** 5.2
- **GW:** 19.5 kgs / 43.0 lbs
- **Carton Size (cm):** 75 x 33.1 x 59.0 (29.5" x 13.0" x 23.2")
- **Humidity:** 5% - 95% Non-condensing

Dimension

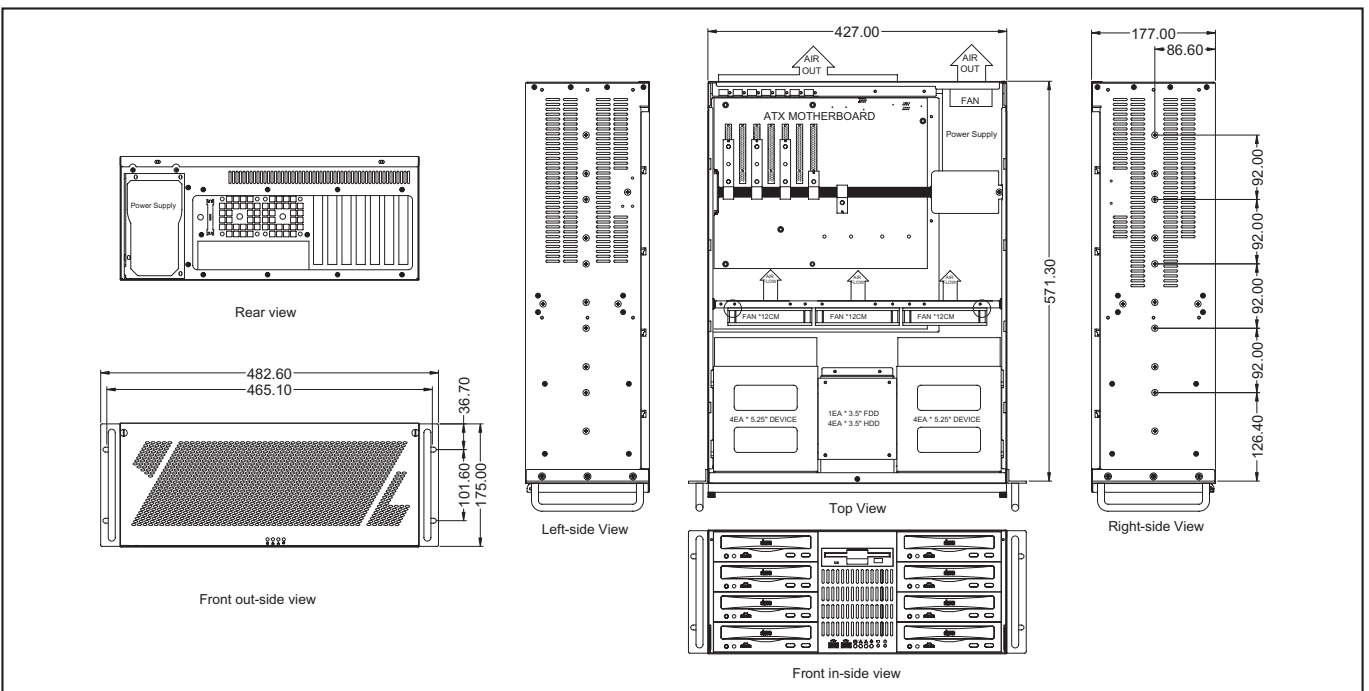

GHI-442

4U Rackmount Chassis

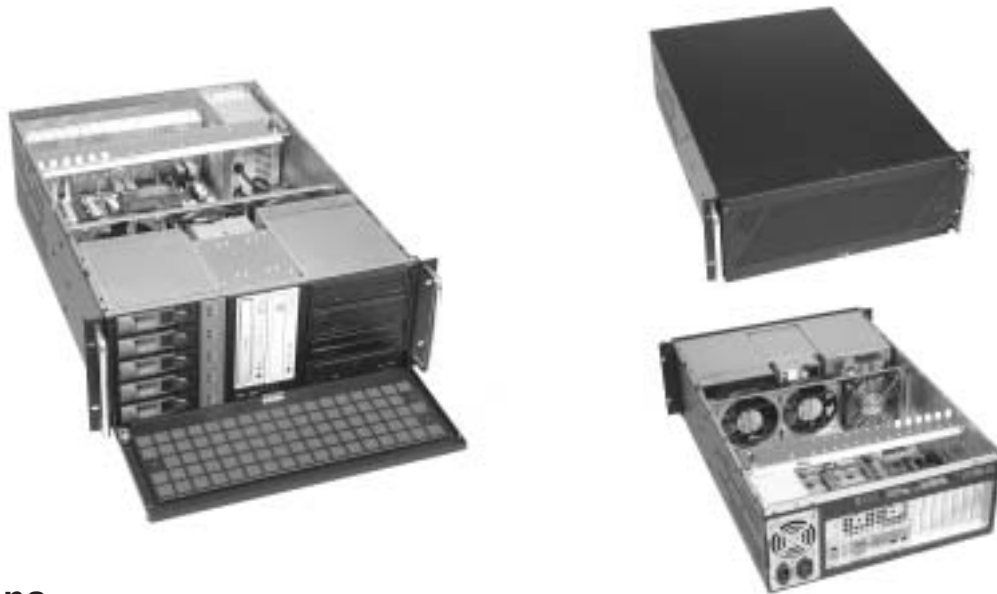

Specifications

- **EIA RS-310C 19" Rackmount Standard**
- **Construction:** Heavy Duty Cold Rolled Electroplated Steel
- **Color:** Black (Standard), Beige or Custom
- **System Boards:** Pentium 4, Dual Xeon, Athlon 64, Dual Opteron
- **Supports EATX M/B (Max. to 12" x 13") SSI EEB 3.0**
- **Drive Capacity:** 10x CD-ROM or 12x 3.5"HDD & 2x CD-ROM
- **Power Supply (Optional):** Single PS2 up to 700W or Mini Redundant up to 500W ATX P/S (Rear Installation) Max Depth 300mm
- **Cooling:** 3x (120mm = 90CFM ea.) Fans & 2x (60mm 23.5CFM ea.) Fans (Optional)
- **Front Door:** Single Door with 2 Thumbscrews and Removable Door
- **Air Filter:** Inside Front Door (Washable)
- **Connector Port (Front):** 2x USB Ports
- **Indicators:** LEDs for Power ON/OFF, HDD Activity, 2x LAN
- **Flexible Hold Down Bar Designed**
- **Switch:** Power ON/OFF Momentary (Dimple), System Reset
- **Dimensions (WxHxD):** 483x177x624mm (19"x7.0"x24.5")
- **Cuft:** 5.7
- **GW:** 19.1 kgs / 42.1 lbs
- **Carton Size (cm):** 85.5x34.0x56.5 (33.7" x 13.4" x 22.2")
- **Humidity:** 5% - 95% Non-condensing

Dimension

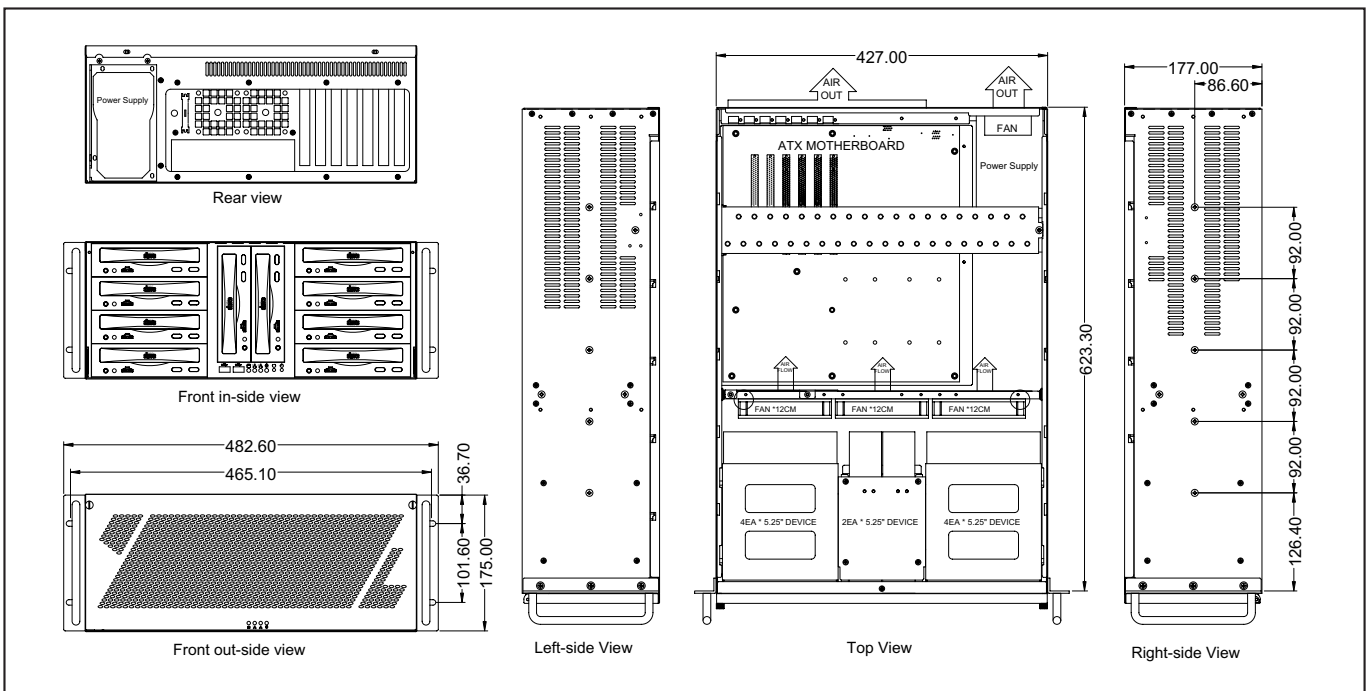

GHI-450

4U Wallmount Chassis



Specifications

- **EIA RS-310C 19" Rackmount Standard**
- **Construction:** Heavy Duty Cold Rolled Electroplated Steel
- **Color:** Black (Standard), Beige or Custom
- **System Boards:** Pentium 4, Dual Xeon, Athlon 64, Dual Opteron
- **Support ATX M/B(Max. to 12" x13")**
- **Drive Capacity:** 2x 3.5"HDD & 1xSlim FDD & 1xSlim CD-ROM
- **Power Supply (Optional):** PS/2 Size Single up to 700W or Mini Redundant up to 500W ATX P/S (Rear Installation) Max. Depth 200mm
- **Cooling:** 4x (92mm = 51CFM ea.) Hot Swap Fans
- **Air Filter:** Inside Front Panel (Washable)
- **Indicators:** LEDs for Power ON/OFF, HDD Activity
- **Switch:** Power ON/OFF Momentary (Pushbutton), System Reset
- **Flexible Hold Down Bar Designed**
- **Dimensions (W x H x D):** 431 x 222 x 557mm (17.0" x 8.7" x 21.9")
- **Cuft:** 5.9
- **GW:** 21.3 kgs / 47.0 lbs
- **Carton Size(cm):** 55.5 x 42.5 x 70.5 (21.9" x 16.7" x 27.8")
- **Humidity:** 5% - 95% Non-condensing

Dimension

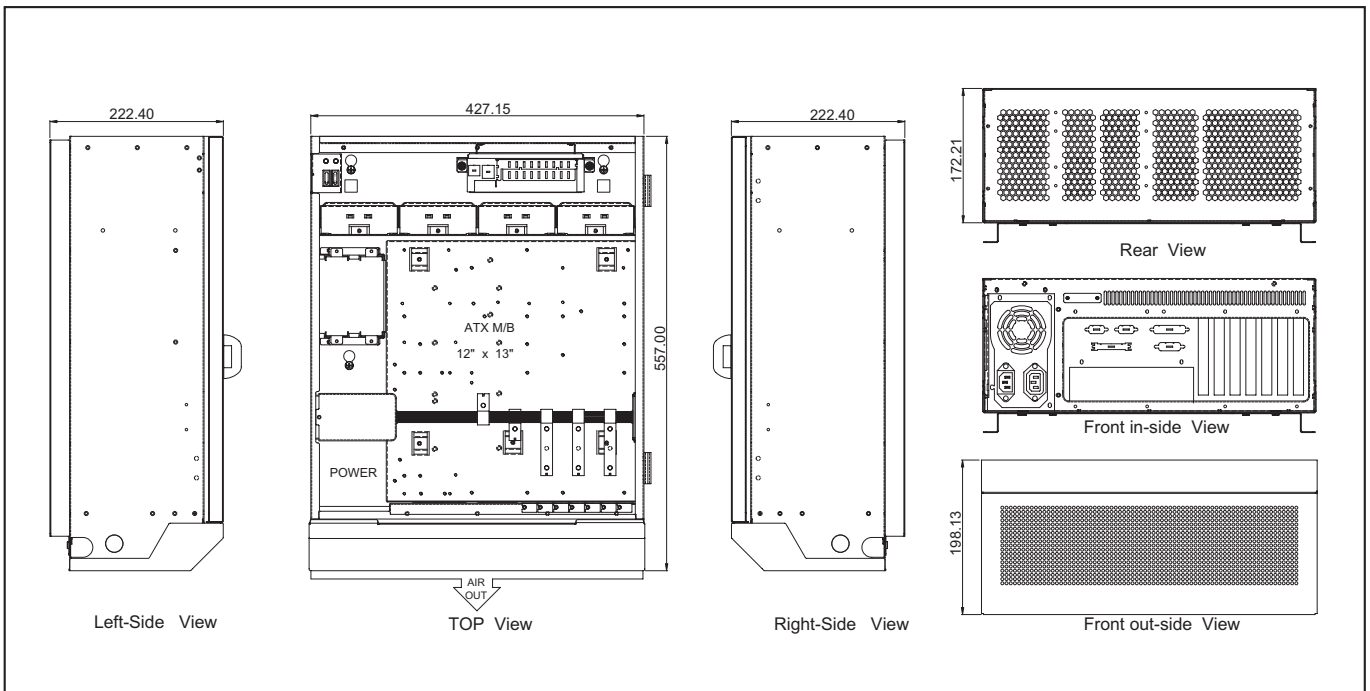

GHI-480

4U Rackmount Chassis



Specifications

- **EIA RS-310C 19" Rackmount Standard**
- **Construction:** Heavy Duty Cold Rolled Electroplated Steel
- **Color:** Black (standard), Beige or Custom
- **System Boards:** Pentium 4, Dual Xeon, Athlon 64, Dual Opteron
- **Support EATX M/B (Max. to 12" x 13") SSI EEB 3.0**
- **Drive Capacity:** 1xSlim CD-ROM & 1xSlim FDD & 16x3.5"Swappable IDE/SATA/SCSI 320/ Multilane SATA/SAS (Optional)Trays & 2x2.5"HDD & 2 x 3.5"HDD(Optional)
- **Power Supply (Optional):** N+1 Redundant up to 950W ATX P/S (Rear Installation)
- **Cooling:** 3x(12cm) Fans(90CFM ea.) & 2x(6cm) Fans(23.5CFM ea.) (Optional)
- **Front Door:** Single Door with 2 Thumb Screws(Removable)
- **Connector Port(Front):** 2xUSB Ports
- **Thermal Management Card:** GHA-CO04
- **Indicators:** LEDs for Power ON/OFF, HDD Activity, Fan, Temperature, LAN
- **Flexible Hold Down Bar Designed**
- **Switch:** Power ON/OFF Momentary (Dimple), System Reset, Buzzer Reset
- **Dimensions(WxHxD):** 483x177x 650mm(19"x7.0" x 25.6")
- **Cuft:** 5.8
- **GW:** 28.0kgs / 61.7lbs
- **Carton Size(cm):** 85.4 x 33.6 x 57.6(33.6" x 13.2" x 22.7")
- **Humidity:** 5% - 95% Non-condensing

Dimension

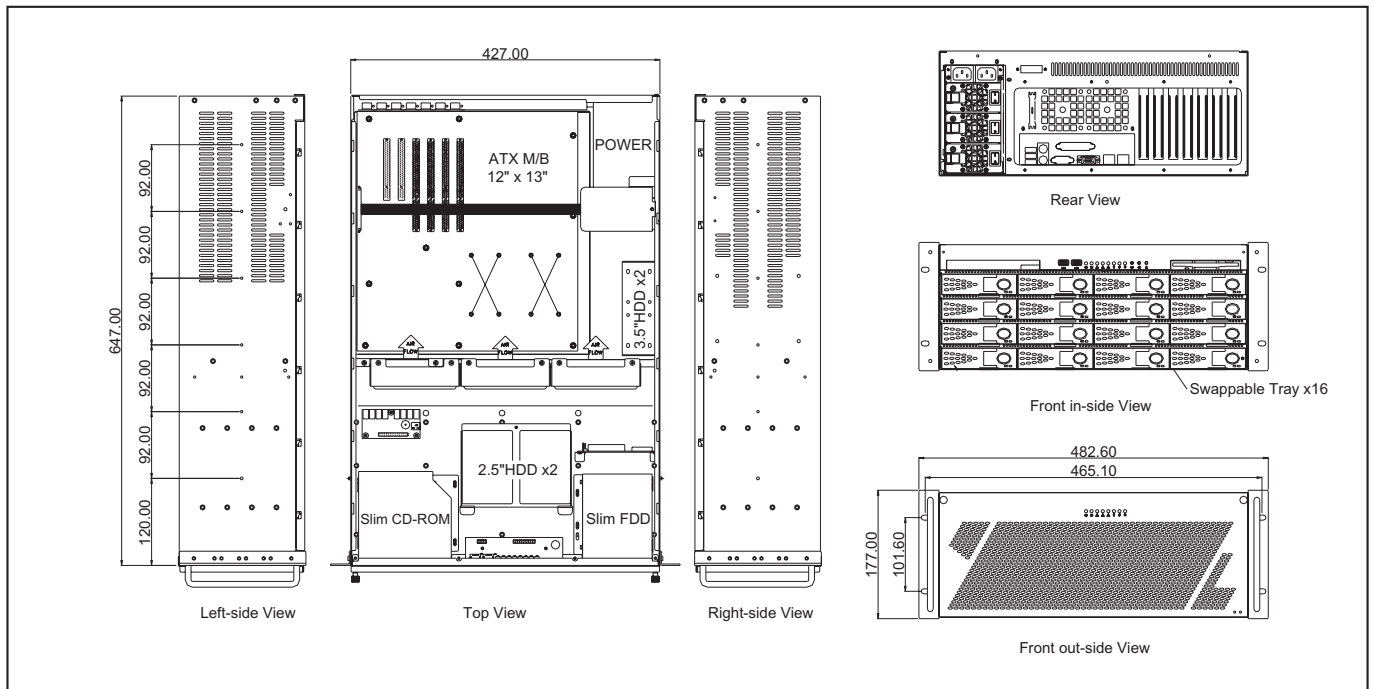

GHI-481

4U Rackmount Chassis



Specifications

- **EIA RS-310C 19" Rackmount Standard**
- **Construction:** Heavy Duty Cold Rolled Electroplated Steel
- **Color:** Black (Standard), Beige or Custom
- **System Boards:** Pentium 4, Dual Xeon, Athlon 64, Dual Opteron
- **Support EATX M/B (Max. to 12" x 13") SSI EEB 3.0**
- **Drive Capacity:** 1x5.25" & 1xSlim CD-ROM & 1xSlim FDD & 14x3.5" Swappable IDE/SATA/SCSI 320/ Multilane SATA/SAS(Optional)Trays & 2 x 3.5"HDD(Optional)
- **Power Supply (Optional):** N+1 Redundant up to 950W ATX P/S (Rear Installation)
- **Cooling:** 3x(12cm) Fans(90CFM ea.) & 2x(6cm) Fans(23.5CFM ea.) (Optional)
- **Front Door:** Single Door with 2 Thumb Screws(Removable)
- **Connector Port(Front):** 2xUSB Ports
- **Thermal Management Card:** GHA-CO04
- **Indicators:** LEDs for Power ON/OFF, HDD Activity, Fan, Temperature, LAN
- **Flexible Hold Down Bar Designed**
- **Switch:** Power ON/OFF Momentary (Dimple), System Reset, Buzzer Reset
- **Dimensions(WxHxD):** 483x177x650mm(19" x 7.0" x 25.6")
- **Cuft:** 5.8
- **GW:** 28.0kgs / 61.7lbs
- **Carton Size(cm):** 85.4 x 33.6 x 57.6(33.6" x 13.2" x 22.7")
- **Humidity:** 5% - 95% Non-condensing

Dimension

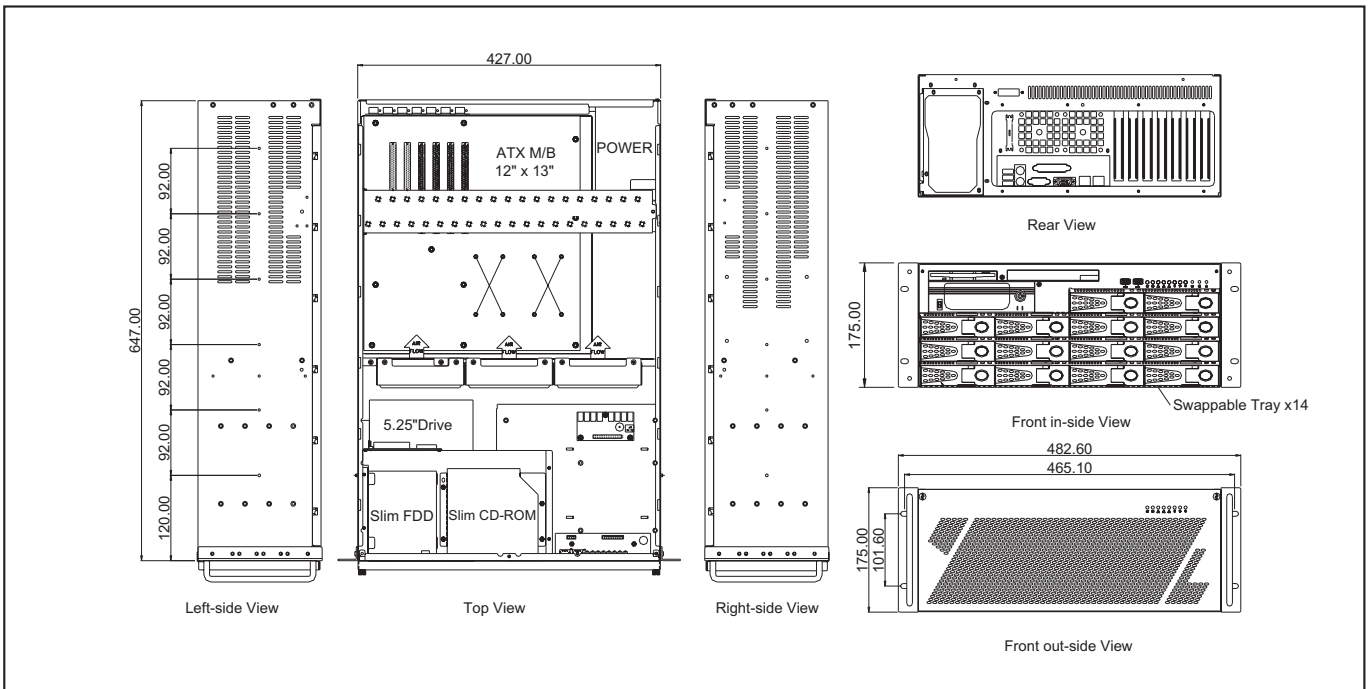

GH-520SR/530ATXR

5U Rackmount Chassis



19" Rackmount

Specifications

- **EIA RS-310C 19" Rackmount Standard**
- **Construction:** Heavy Duty Cold Rolled Electroplated Steel
- **Color:** Black (Standard), Beige or Custom
- **System Boards:** Pentium 4, Dual Xeon, Athlon 64, Dual Opteron
- **Support 20-slot Passive Backplane (520SR)**
- **Support EATX M/B (Max. to 12" x 13") SSI EEB 3.0 (530ATXR)**
- **Drive Capacity:** 4x 5.25" & 1x 3.5"
- **Power Supply (Optional):** Vertical Redundant up to 400W ATX P/S or DC to DC-48V 300W P/S(Front Installation) Max. Depth 220mm
- **Cooling:** Hot Swappable 4x(9cm) Fans(51CFM ea.) or Hot Swappable 3x (120mm = 90CFM ea.) Fans (Optional)
- **Air Filter:** Inside Front Door (Washable)
- **Front Door:** Single Door with 1 Thumb Twist Keylock
- **Thermal Management Card:** GHA-CO01
- **Indicators:** LEDs for Power ON/OFF, HDD Activity, Fan, Temperature
- **Flexible Hold Down Bar Designed**
- **Switch:** Power ON/OFF Momentary or AT (Pushbutton), System Reset, Buzzer Reset
- **Dimensions (WxHxD):** 483x222x671mm (19" x 8.75" x 26.4")
- **Cuft:** 6.8
- **GW:** 26.0kgs / 57.3lbs
- **Carton Size(cm):** 61.0 x 37.0 x 85.5 (24.0" x 14.6" x 33.7")
- **Humidity:** 5% - 95% Non-condensing

Dimension

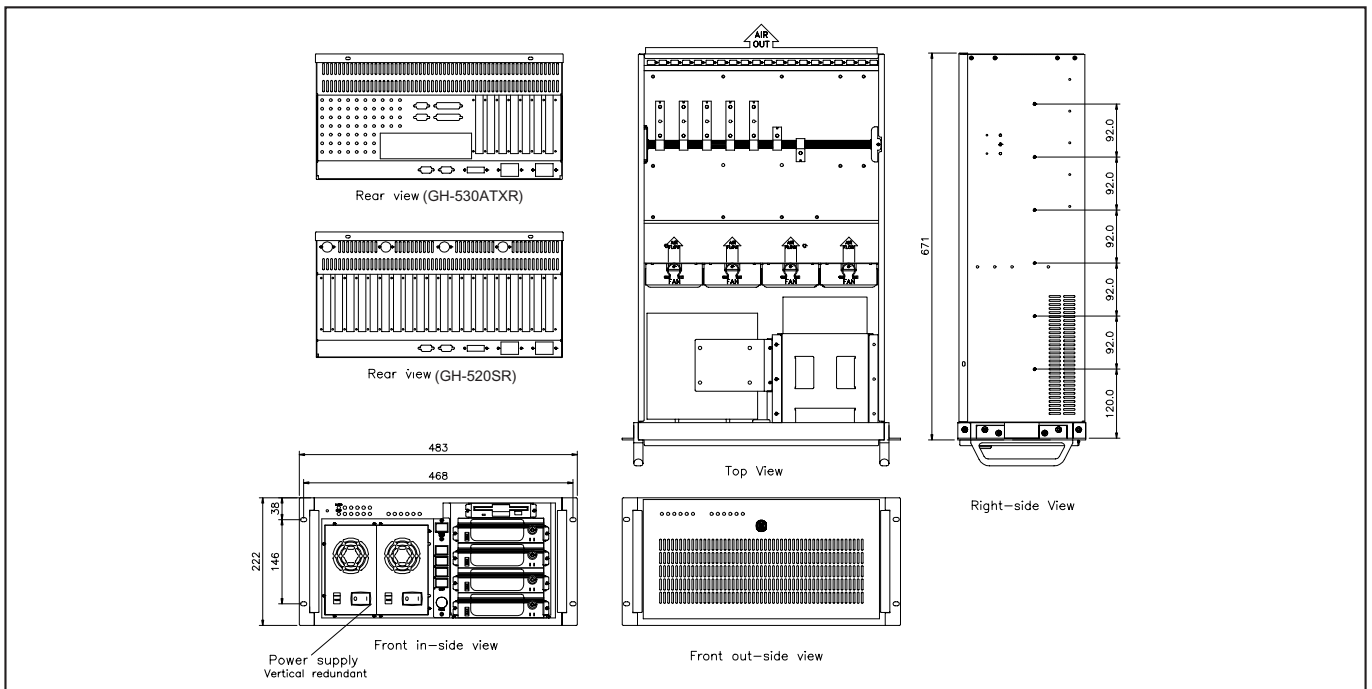

GHI-580

5U Rackmount Chassis

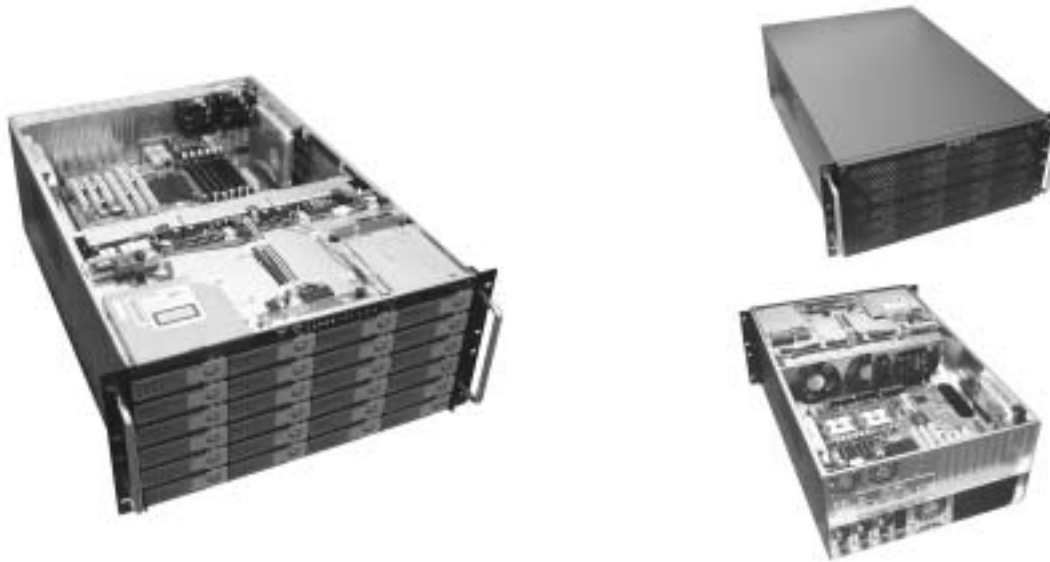

Specifications

- **EIA RS-310C 19" Rackmount Standard**
- **Construction:** Heavy Duty Cold Rolled Electroplated Steel
- **Color:** Black (Standard), Beige or Custom
- **System Boards:** Pentium 4, Dual Xeon, Athlon 64, Dual Opteron, Quad Opteron
- **Support EATX M/B (Max. to 12" x 13") SSI EEB 3.0 With Removable Drawer**
- **Drive Capacity:** 1x Slim CD-ROM & 1x Slim FDD & 24x 3.5"Swappable, 2x 2.5"HDD & 2 x 3.5"HDD(Optional)
- **Drive Interface:** PATA, SATA, SCSI320, Multilane SATA or SAS
- **Power Supply (Optional):** 2x Redundant up to 500W ATX P/S ea. (Rear Installation) Max Depth 275mm
- **Cooling:** 3x (120mm = 90CFM ea.) Fans & 1x (80mm 42.5CFM ea.) Fan & 2x (60mm = 23.5CFM ea.) Fans
- **Front Door:** Single Door with 2 Thumbscrews(Removable)
- **Connector Port (Front):** 2x USB Ports
- **Thermal Management Card:** GHA-CO04
- **Indicators:** LEDs for Power ON/OFF, HDD Activity, Fan, Temperature, LAN
- **Flexible Hold Down Bar Designed**
- **Switch:** Power ON/OFF Momentary (Dimple), System Reset, Buzzer Reset
- **Dimensions (WxHxD):** 483x222x650mm(19"x8.7"x 25.6")
- **Cuft:** 6.8
- **GW:** 33.5kgs / 73.9lbs
- **Carton Size (cm):** 85.5 x 37.0 x 61.0(33.7" x 14.6" x 24.0")
- **Humidity:** 5% - 95% Non-condensing

Dimension

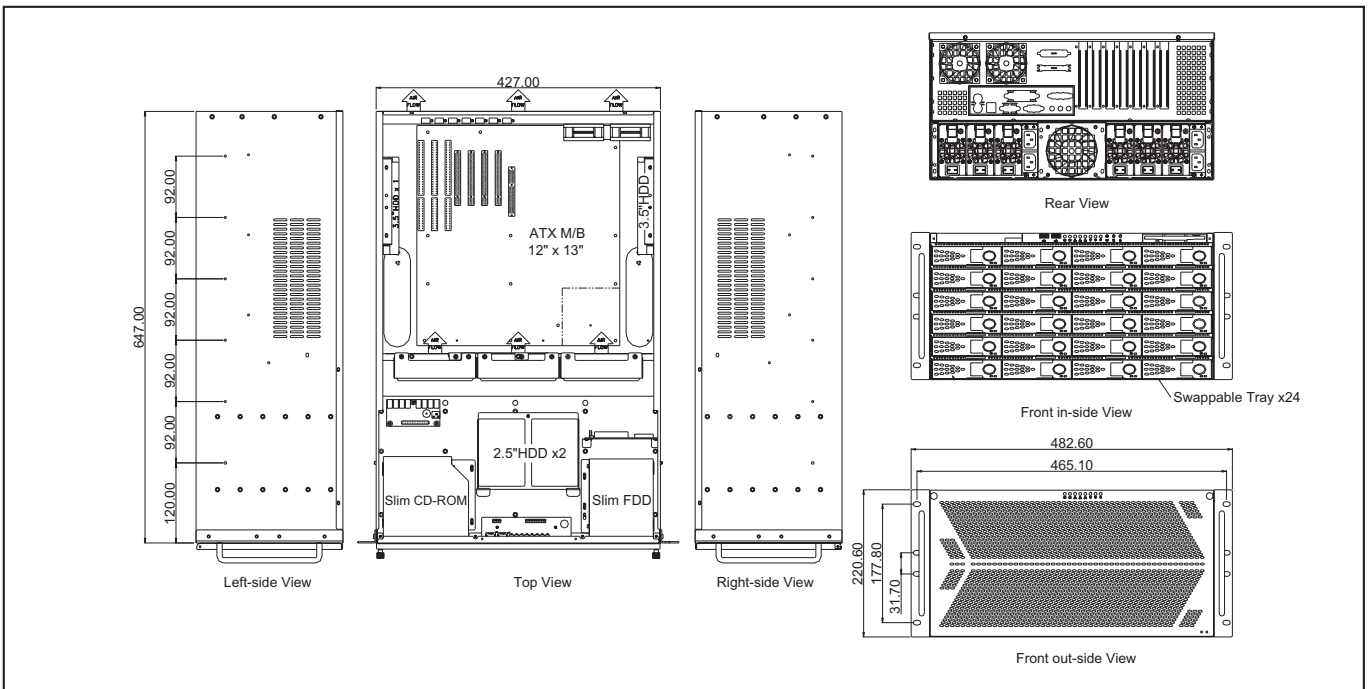

GHI-581

5U Rackmount Chassis



Specifications

- **EIA RS-310C 19" Rackmount Standard**
- **Construction:** Heavy Duty Cold Rolled Electroplated Steel
- **Color:** Black (Standard), Beige or Custom
- **System Boards:** Pentium 4, Dual Xeon, Athlon 64, Dual Opteron
- **Supports EATX M/B (Max. to 12" x 13") SSI EEB 3.0 With Removable Drawer**
- **Drive Capacity:** 1x 5.25", 1x Slim FDD & 22x 3.5" Hot Swappable Trays & 1x 2.5"HDD & 2x 3.5"HDD (Optional)
- **Drive Interface:** PATA, SATA, SCSI320, Multilane SATA or SAS
- **Power Supply (Optional):** 2x Redundant up to 500W ATX P/S ea. (Rear Installation) Max Depth 275mm
- **Cooling:** 3x (120mm = 90CFM ea.) Fans & 1x (80mm 42.5CFM ea.) Fan & 2x (60mm = 23.5CFM ea.) Fans
- **Front Door:** Single Door with 2 Thumbscrews (Removable)
- **Connector Port (Front):** 2x USB Ports
- **Thermal Management Card:** GHA-CO04
- **Indicators:** LEDs for Power ON/OFF, HDD Activity, Fan, Temperature, LAN
- **Flexible Hold Down Bar Designed**
- **Switch:** Power ON/OFF Momentary (Dimple), System Reset, Buzzer Reset
- **Dimensions (WxHxD):** 483x222x650mm(19"x8.7"x25.6")
- **Cuft:** 6.8
- **GW:** 33.5kgs / 73.9lbs
- **Carton Size (cm):** 85.5x37.0x61.0 (33.7" x 14.6" x 24.0")
- **Humidity:** 5% - 95% Non-condensing

Dimension

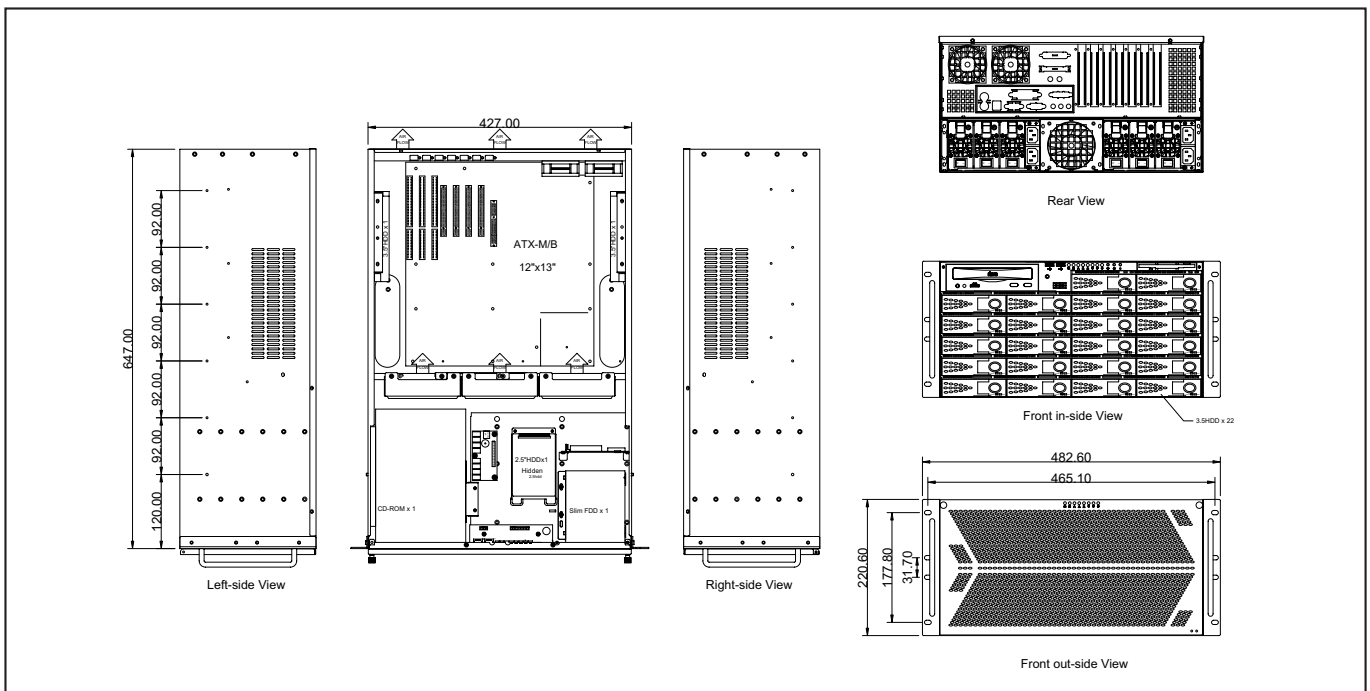

GHI-583

5U Rackmount Chassis

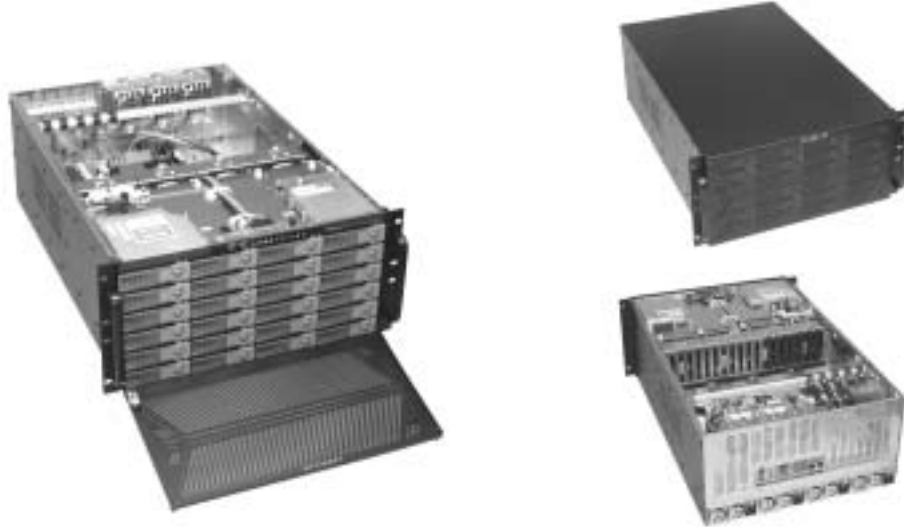

Specifications

- **EIA RS-310C 19" Rackmount Standard**
- **Construction:** Heavy Duty Cold Rolled Electroplated Steel
- **Color:** Black (Standard), Beige or Custom
- **System Boards:** Pentium 4, Dual Xeon, Athlon 64, Dual Opteron, Quad Opteron
- **Supports EATX M/B (Max. to 13" x 16") With Removable Drawer**
- **Drive Capacity:** 1x Slim CD-ROM, 1x Slim FDD & 24x 3.5" Hot Swappable & 2x 2.5" HDD & 2 x 3.5" HDD (Optional)
- **Drive Interface:** PATA, SATA, SCSI320, Multilane SATA or SAS
- **Power Supply (Optional):** 1U Redundant up to 1650W ATX P/S (Rear Installation) Max Depth 300mm
- **Cooling:** 4x (92mm = 51CFM ea.) Fans & 3x (60mm 23.5CFM ea.) Fans
- **Front Door:** Single Door with 2 Thumbscrews(Removable)
- **Connector Port (Front):** 2x USB Ports
- **Thermal Management Card:** GHA-CO04
- **Indicators:** LEDs for Power ON/OFF, HDD Activity, Fan, Temperature, LAN
- **Flexible Hold Down Bar Designed**
- **Switch:** Power ON/OFF Momentary (Dimple), System Reset, Buzzer Reset
- **Dimensions(WxHxD):** 483x222x650mm(19" x 8.7" x 25.6")
- **Cuft:** 6.8
- **GW:** 33.5kgs / 73.9lbs
- **Carton Size (cm):** 85.5 x 37.0 x 61.0 (33.7"x14.6"x 24.0")
- **Humidity:** 5% - 95% Non-condensing

Dimension

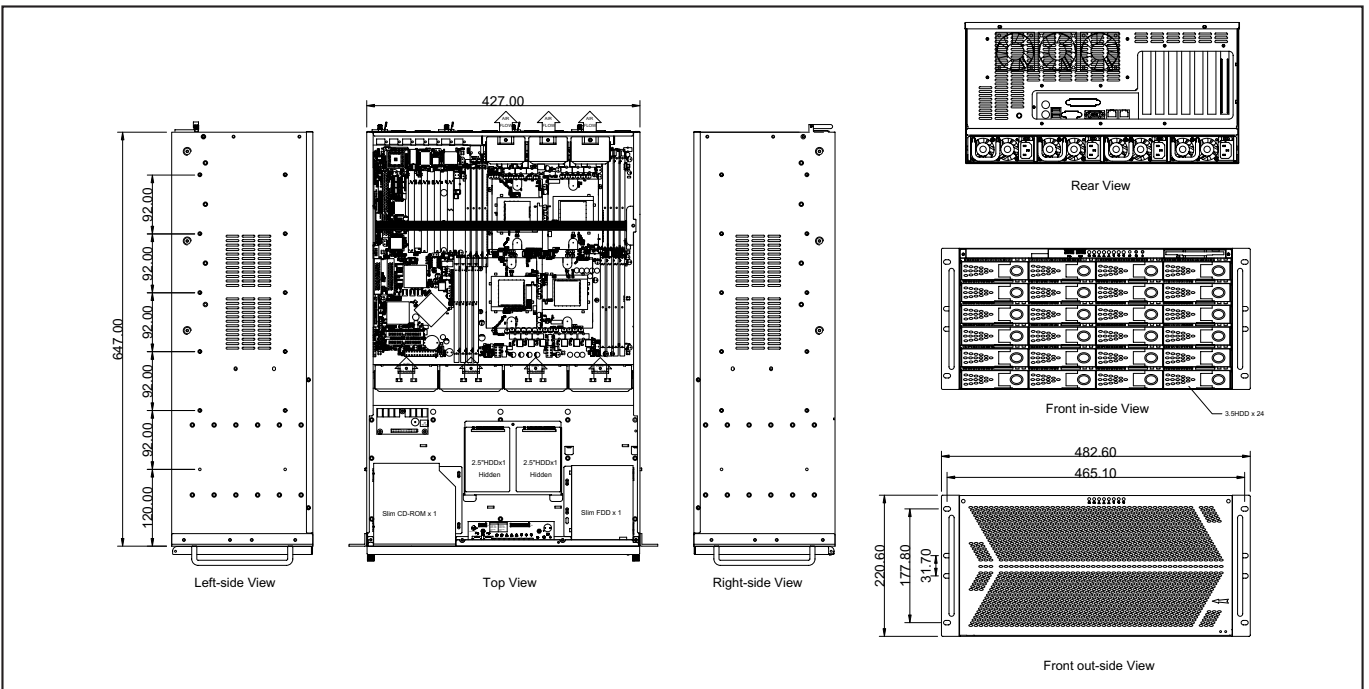

GHI-584

5U Rackmount Chassis



19" Rackmount

Specifications

- **EIA RS-310C 19" Rackmount Standard**
- **Construction:** Heavy Duty Cold Rolled Electroplated Steel
- **Color:** Black (Standard), Beige or Custom
- **System Boards:** Pentium 4, Dual Xeon, Athlon 64, Dual Opteron, Quad Opteron
- **Supports EATX 2 Layer M/B (Max. to 13" x 16") With Removable Drawer**
- **Drive Capacity:** 1x Slim CD-ROM, 1x Slim FDD & 24x 3.5" Hot Swappable & 2x 2.5" HDD & 2 x 3.5" HDD (Optional)
- **Drive Interface:** PATA, SATA, SCSI320, Multilane SATA or SAS
- **Power Supply (Optional):** 1U Redundant up to 1650W ATX P/S (Rear Installation) Max Depth 300mm
- **Cooling:** 6x (60mm = 23.5CFM ea.) Fans & 2x (120mm 90CFM ea.) Fans
- **Front Door:** Single Door With 2 Thumbscrews (Removable)
- **Connector Port (Front):** 2x USB Ports
- **Thermal Management Card:** GHA-CO04
- **Indicators:** LEDs for Power ON/OFF, HDD Activity, Fan, Temperature, LAN
- **Flexible Hold Down Bar Designed**
- **Switch:** Power ON/OFF Momentary (Dimple), System Reset, Buzzer Reset
- **Dimensions (W x H x D):** 483 x 222 x 650mm (19" x 8.7" x 25.6")
- **Cuft:** 6.8
- **GW:** 34.5kgs / 76.1lbs
- **Carton Size (cm):** 85.5 x 37.0 x 61.0 (33.7" x 14.6" x 24.0")
- **Humidity:** 5% - 95% Non-condensing

Dimension

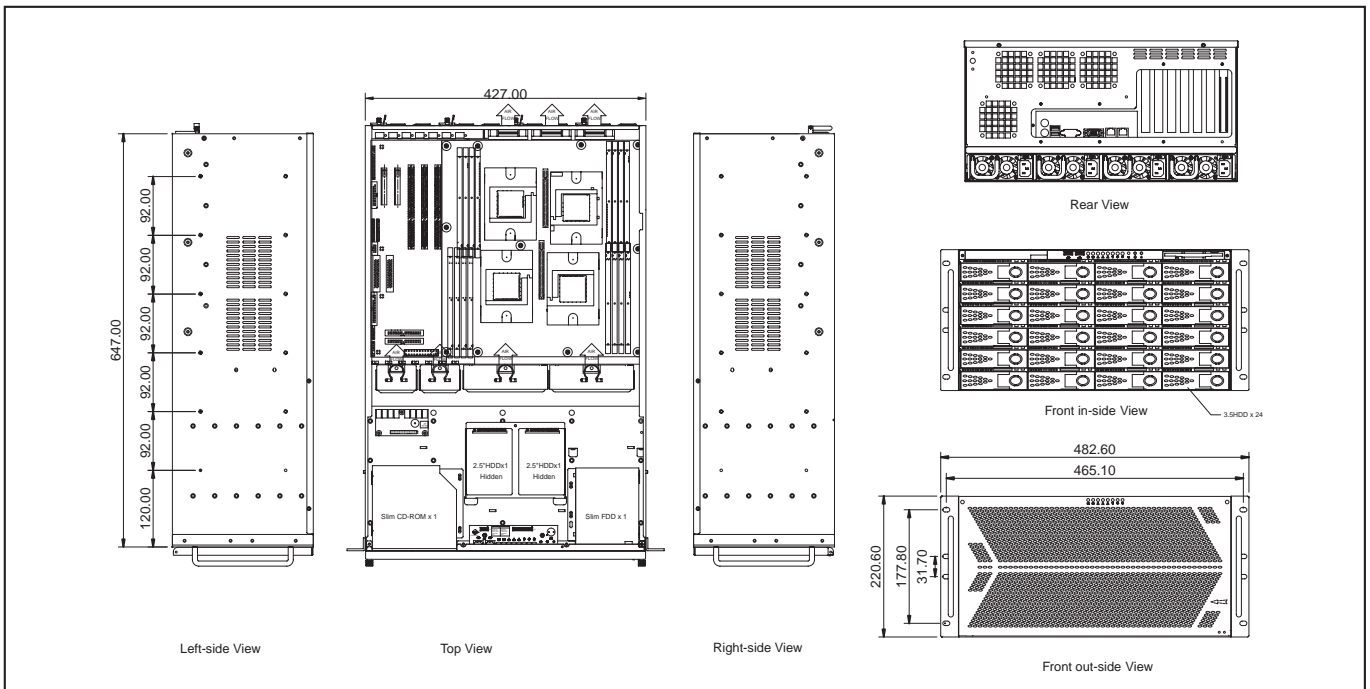

GH-600ATXR/620SR

6U Rackmount Chassis



19" Rackmount

Specifications

- **EIA RS-310C 19" Rackmount Standard**
- **Construction:** Heavy Duty Cold Rolled Electroplated Steel
- **Color:** Black (Standard), Beige or Custom
- **System Boards:** Dual Xeon, Pentium 4, Dual Pentium III
- **Support EATX M/B (Max. to 12" x 13") SSI EEB 3.0 With Removable Drawer (600ATX)**
- **Support 20-slot Passive Backplane With Removable Drawer (620SR)**
- **Drive Capacity:** 7x 5.25" & 1x 3.5"
- **Power Supply (Optional):** PS/2 Size Single up to 700W or Horizontal Redundant up to 550W or Mini Redundant up to 500W ATX P/S(Rear Installation)
- **Cooling:** Hot Swappable 4x (90mm = 51CFM ea.) Fans
- **Front Door:** Single Door With Keylock
- **Air Filter:** Inside Front Door (Washable)
- **Thermal Management Card:** GHA-CO01
- **Indicators:** LEDs for Power ON/OFF, HDD Activity, Fan, Temperature
- **Flexible Hold Down Bar Designed**
- **Switch:** Power ON/OFF Momentary or AT (Pushbutton), System Reset, Buzzer Reset
- **Dimensions (W x H x D):** 483 x 267 x 671mm (19" x 10.5" x 26.4")
- **Cuft:** 7.7
- **GW:** 29.0kgs / 64.0lbs
- **Carton Size (cm):** 61.0 x 41.8 x 85.5 (24.0" x 16.5" x 33.7")
- **Humidity:** 5% - 95% Non-condensing

Dimension

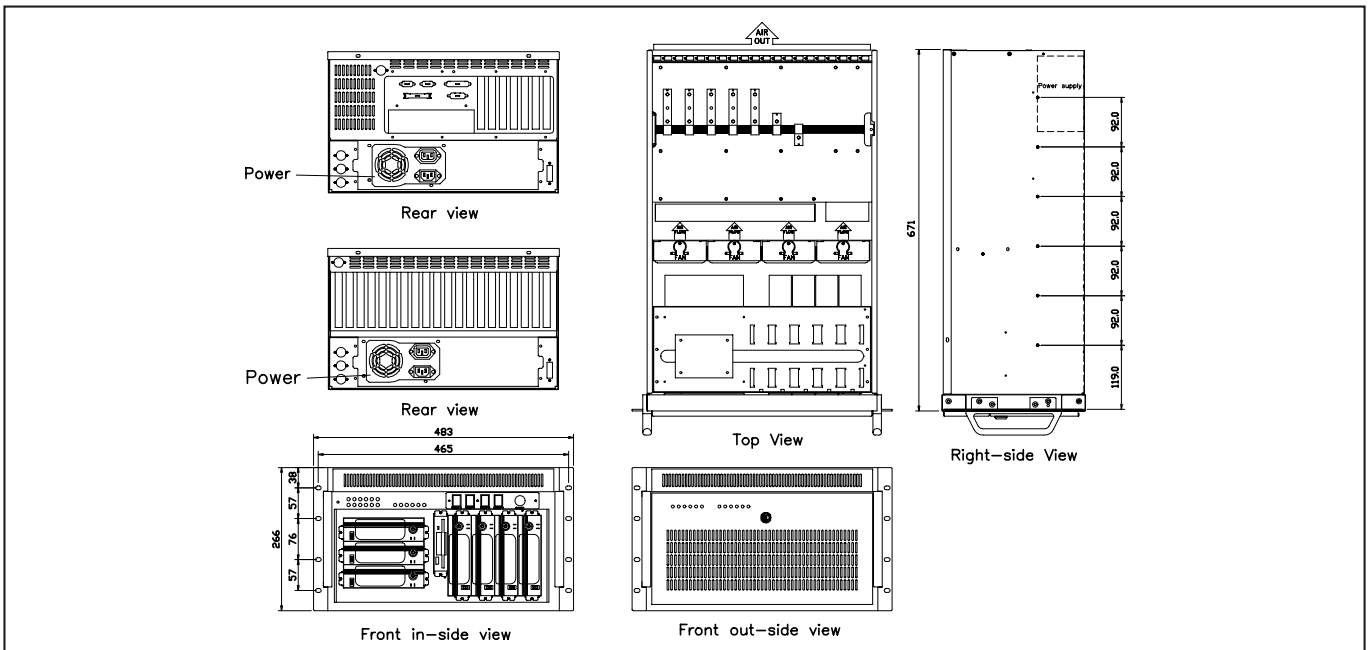

GHI-611

6U Rackmount Chassis



Specifications

- **EIA RS-310C 19" Rackmount Standard**
- **Construction:** Heavy Duty Cold Rolled Electroplated Steel
- **Color:** Black (Standard), Beige or Custom
- **Support 20-slot Passive Backplane with Removable Drawer**
- **Drive Capacity:** 4x 5.25" & 2x 3.5" HDD
- **Power Supply (Optional):** PS/2 Size Single up to 700W or Horizontal Redundant up to 550W or Mini Redundant up to 500W ATX P/S (Rear Installation)
- **Cooling:** Hot Swappable 4x (90mm = 51CFM ea.) Fans
- **Front Door:** Single Door with 1 Thumb Twist Keylock
- **Air Filter:** Inside Front Door (Washable)
- **Thermal Management Card:** GHA-CO03
- **Indicators:** LEDs for Power ON/OFF, HDD Activity, Fan, Temperature
- **Flexible Hold Down Bar Designed**
- **Switch:** Power ON/OFF Momentary or AT (Pushbutton), System Reset, Buzzer Reset
- **Dimensions(WxHxD):** 483x267x463mm (19"x10.5"x18.2")
- **Cuft:** 5.8
- **GW:** 25.3kgs / 55.8lbs
- **Carton Size (cm):** 61.0x 41.8 x 64.7 (24.0" x 16.5" x 25.5")
- **Humidity:** 5% - 95% Non-condensing

Dimension

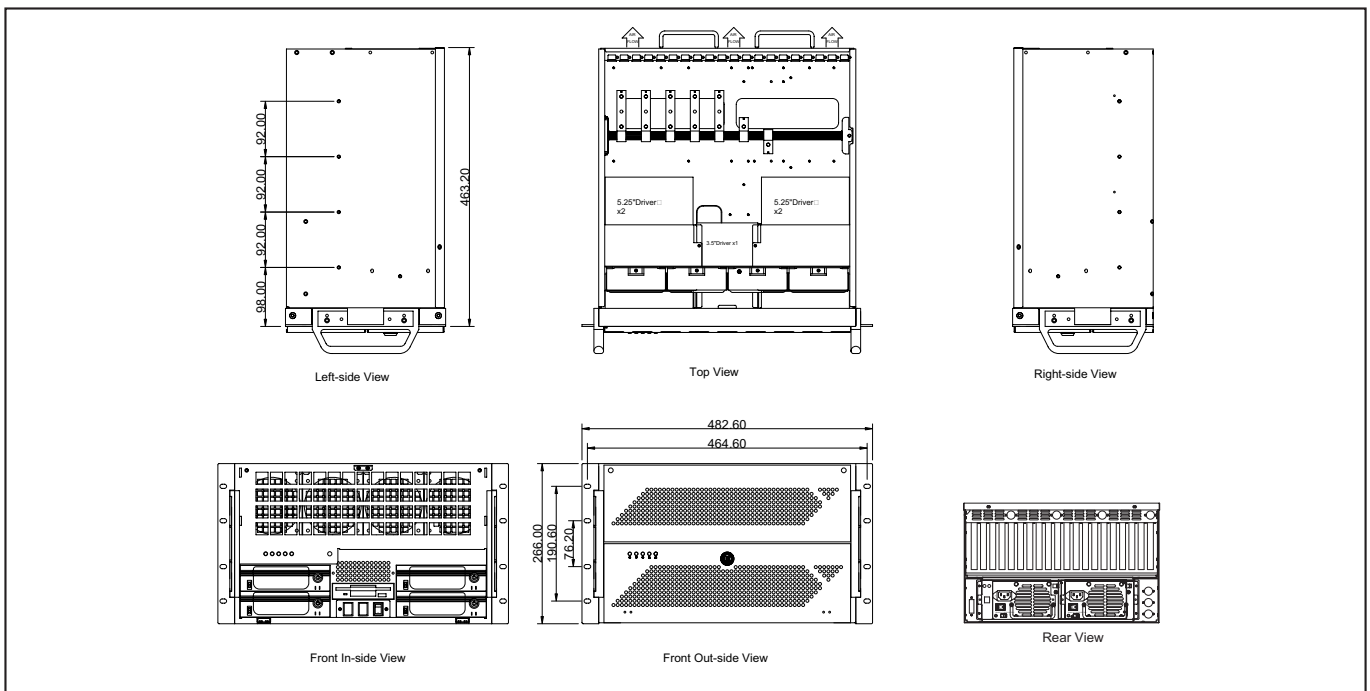

GHI-690

6U Rackmount Chassis



Specifications

- **EIA RS-310C 19" Rackmount Standard**
- **Construction:** Heavy Duty Cold Rolled Electroplated Steel
- **Color:** Black (Standard), Beige or Custom
- **System Boards:** Pentium 4, Dual Xeon, Athlon 64, Dual Opteron, Quad Opteron
- **Supports EATX M/B (Max. to 13" x 16") With Removable Drawer**
- **Drive Capacity:** 36 x 3.5" Swapple HDD
- **Drive Interface:** PATA, SATA, SCSI320, Multilane SATA or SAS
- **Power Supply (Optional):** 1U Redundant up to 1650W ATX P/S (Rear Installation) Max Depth 300mm
- **Cooling:** 4x (92mm = 51CFM ea.) Fans & 3x (60mm = 23.5CFM ea.) Fans
- **Front Door:** Double Horizontal Doors With 2 Thumbscrews
- **Thermal Management Card:** GHA-CO08
- **Indicators:** LEDs for Power ON/OFF, HDD Power/Activity, Fan, Temperature, LAN
- **Flexible Hold Down Bar Designed**
- **Switch:** Power ON/OFF Momentary (Dimple), System Reset, Buzzer Reset
- **Dimensions (W x H x D):** 483 x 265 x 666mm (19" x 10.4" x 26.2")
- **Cuft:** 7.7
- **GW:** 36.7 kgs / 80.9 lbs
- **Carton Size (cm):** 61.0 x 41.8 x 85.5 (24.0" x 16.5" x 33.7")
- **Humidity:** 5% - 95% Non-condensing

Dimension

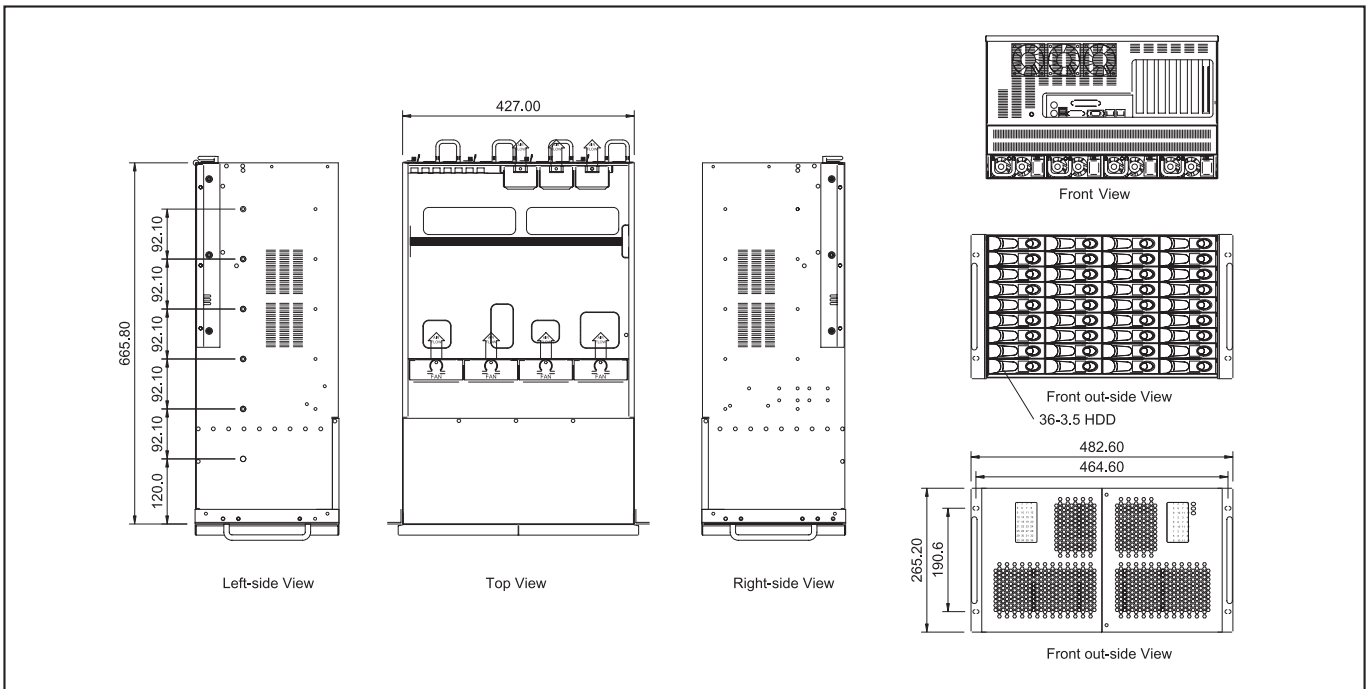

GHI-691

6U Rackmount Chassis



Specifications

- **EIA RS-310C 19" Rackmount Standard**
- **Construction:** Heavy Duty Cold Rolled Electroplated Steel
- **Color:** Black (Standard), Beige or Custom
- **System Boards:** Pentium 4, Dual Xeon, Athlon 64, Dual Opteron, Quad Opteron
- **Supports EATX M/B (Max. to 13" x 16") With Removable Drawer**
- **Drive Capacity:** 1x Slim CD-ROM, 1x Slim FDD & 32" x 3.5" Swapple HDD & 4x3.5" Hot Swapple HDD on Rear Side (Optional)
- **Drive Interface:** PATA, SATA, SCSI320, Multilane SATA or SAS
- **Power Supply (Optional):** 1U Redundant up to 1650W ATX P/S (Rear Installation) Max Depth 300mm
- **Cooling:** 4x (92mm = 51CFM ea.) Fans & 3x (60mm = 23.5CFM ea.) Fans
- **Front Door:** Single Door With 2 Thumbscrews (Removable)
- **Connector Port (Front):** 2x USB Ports
- **Thermal Management Card:** GHA-CO04
- **Indicators:** LEDs for Power ON/OFF, HDD Power/Activity, Fan, Temperature, LAN
- **Flexible Hold Down Bar Designed**
- **Switch:** Power ON/OFF Momentary (Dimple), System Reset, Buzzer Reset
- **Dimensions (W x H x D):** 483 x 265 x 666mm (19" x 10.4" x 26.2")
- **Cuft:** 7.7
- **GW:** 38.3 kgs / 84.5 lbs
- **Carton Size (cm):** 61.0 x 41.8 x 85.5 (24.0" x 16.5" x 33.7")
- **Humidity:** 5% - 95% Non-condensing

Dimension

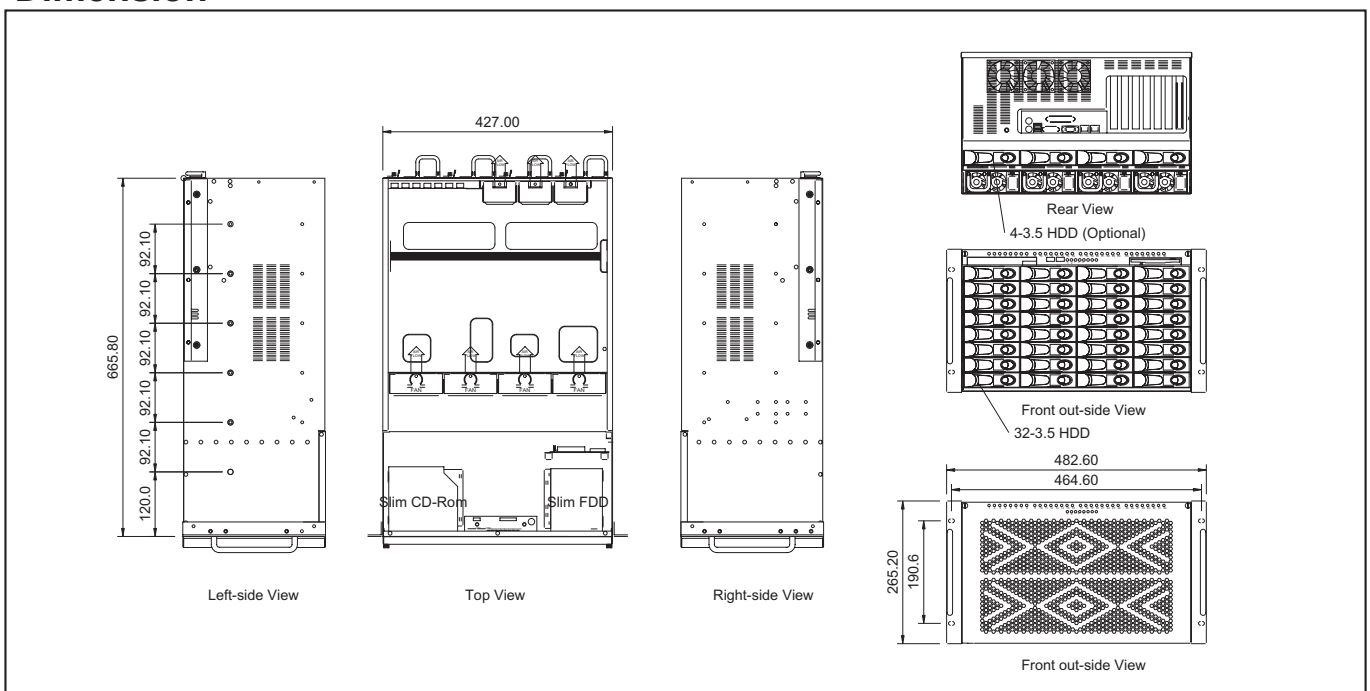

GH-800ATXR/820SR

8U Rackmount Chassis



Specifications

- **EIA RS-310C 19" Rackmount Standard**
- **Construction:** Heavy Duty Cold Rolled Electroplated Steel
- **Color:** Black (Standard), Beige or Custom
- **System Boards:** Dual Xeon, Pentium 4, AMD 64, Dual Opteron, Quad Opteron
- **Support EATX M/B (Max. to 12" x 13") SSI EEB 3.0 With Removable Drawer (800ATXR)**
- **Support 20-slot Passive Backplane With Removable Drawer (820SR)**
- **Drive Capacity:** 7x 5.25" & 1x 3.5"
- **Power Supply (Optional):** PS/2 Size Single up to 700W or Horizontal Redundant up to 550W or Mini Redundant up to 500W ATX P/S (Rear Installation)
- **Cooling:** Hot Swappable 4x(9cm) Fans(51CFM ea.) & 1x(12cm) Fan (108CFM) with Removable Air Filter
- **Front Door:** Single Door With Keylock
- **Air Filter:** Inside Front Door (Washable)
- **Thermal Management Card:** GHA-CO01
- **Indicators:** LEDs for Power ON/OFF, HDD Active, Fan, Temperature
- **Flexible Hold Down Bar Designed**
- **Switch:** Power ON/OFF Momentary (Pushbutton), System Reset, Buzzer Reset
- **Dimensions (W x H x D):** 483(W)x356(H)x510(D)mm(19"x16.5"x18.2")
- **Cuft:** 7.4
- **GW:** 30.5kgs / 67.3lbs
- **Carton Size(cm):** 60.5x50.5x68.5(23.8"x19.9"x27.0")
- **Humidity:** 5% - 95% Non-condensing

Dimension

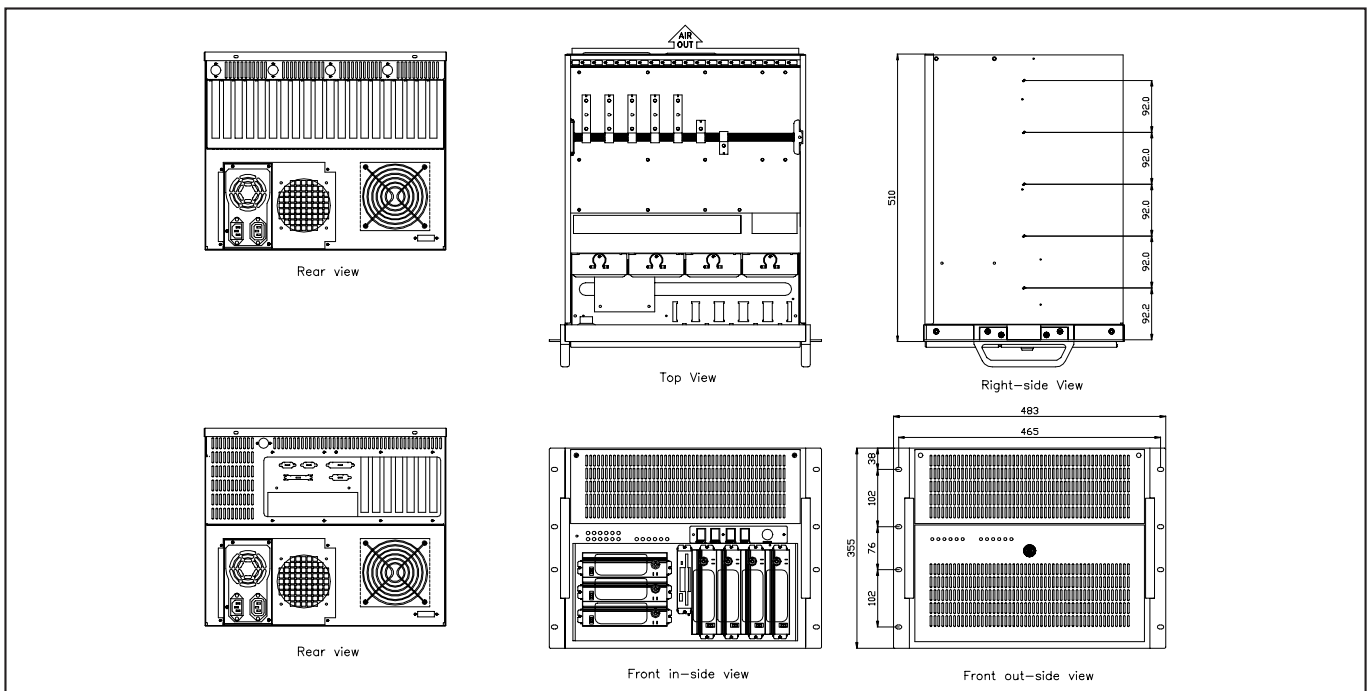

GHI-P01

8U Rackmount Chassis

19" Rackmount



Specifications

- **Meet 19" 8U Height Rack-mount Enclosure with 10 x 1U Nodes**
- **Constructions:** Heavy Duty Cold Rolled Electroplated Steel
- **Color:** Black (Standard), Beige or Custom
- **System Boards:** Dual Xeon, Dual Opteron, Dual Athlon, Pentium 4 800FSB, Dual Pentium III
- **Support ATX M/B (Max. to 12" x 13") With Removable Drawer**
- **Drive Capacity:** 2x3.5"HDD Per Node.(Total 10 nodes = 20xHDD)
- **Power Supply (Optional):** 1U Single up to 460W ATX P/S Per Node (Mid Installation) Max. Depth 300mm
- **Cooling:** 8x (40x28mm = 15.3CFM ea.) Fans & 1x (40x20mm = 8CFM ea.) Fan Per Node
- **Expansion Slots:** 1x Horizontal PCI Slot Per Node.
- **Additional Expansion:** 10 x RJ45 Patch Panel or 20 x RJ45 Patch Panel(Optional)
- **Indicators:** LEDs for Power ON/OFF Momentary (Square Pushbutton), HDD Activity
- **Switch:** Power ON/OFF, System Reset
- **Dimensions(WxHxD):** 483x355x830mm(19"x14.0" x 32.7")
- **Cuft:** 14
- **GW:** 71.3kgs / 157.2lb
- **Carton Size(cm):** 105.5x70.5x53.6(41.5"x27.6"x 21.1")
- **Humidity:** 5% - 95% Non-condensing

Dimension

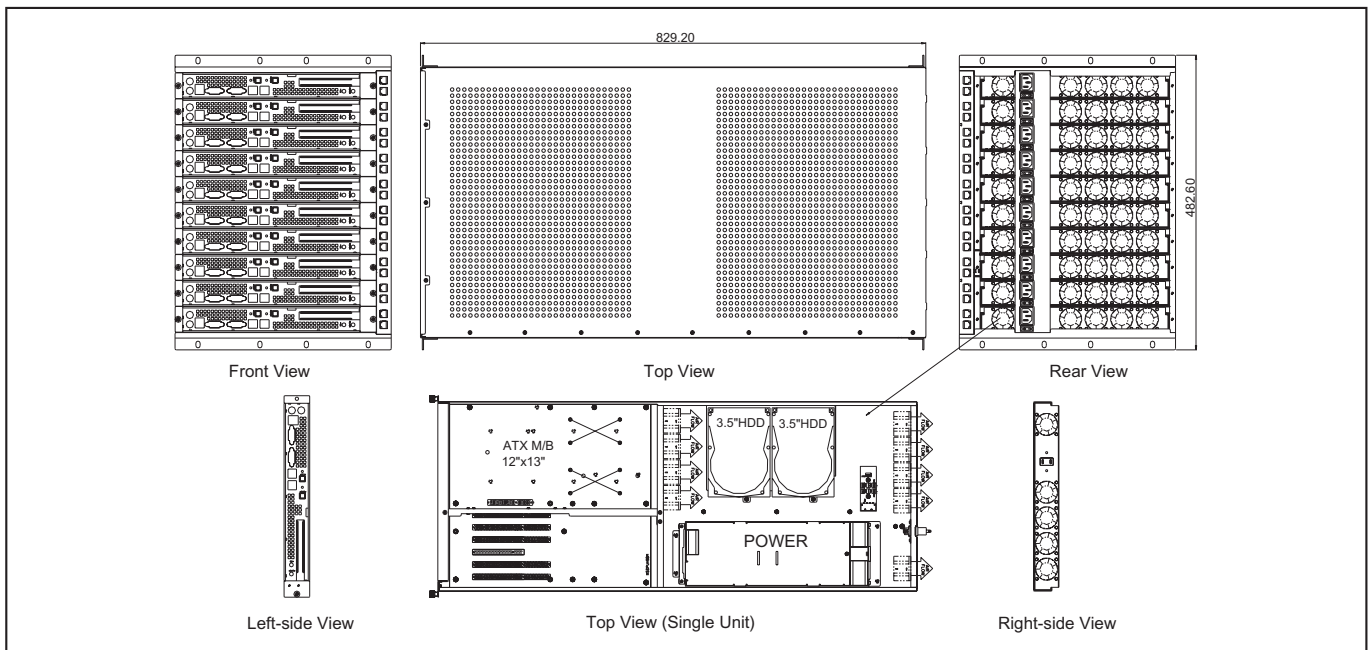

GHB-B04

6U-1/4 Rackmount Chassis



Specifications

- **Mounting:** Rack Mount
- **Construction:** Heavy Duty Cold Rolled Electroplated Steel
- **Color:** Black (Standard), Beige or Custom
- **Support 4-slot Passive Backplane**
- **Drive Capacity:** 1x3.5" & 1x3.5"HDD
- **Power Supply(Optional):** Special Size 150W P/S (Rear Installation)
- **Cooling:** Hot Swappable 1x(92mm = 51CFM ea.) Fan
- **Air Filter:** Inside Front Panel (Washable)
- **Connector Port(Front):** 1xPS/2 Port
- **Indicators:** LEDs for Power ON/OFF, HDD Activity
- **Switch:** Power ON/OFF, System Reset
- **Dimensions (WxHxD):** 110x267x451mm(4.3"x10.5"x17.8")
- **Cuft:** 1.5
- **GW:** 7.0kgs / 15.4lbs
- **Carton Size(cm):** 57.0 x 20.0 x 36.4(22.4" x 7.9" x 14.3")
- **Humidity:** 5% - 95% Non-condensing

Dimension

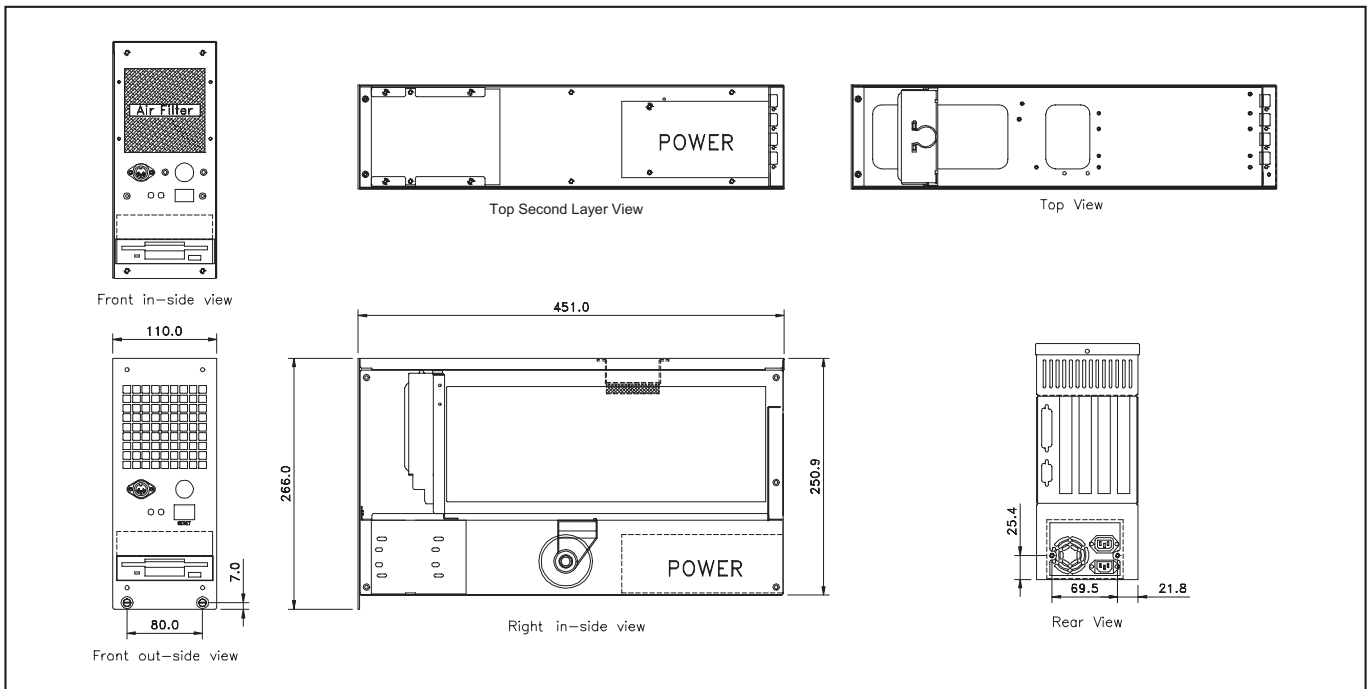

GHB-B05

2-Slot Micro Box Chassis

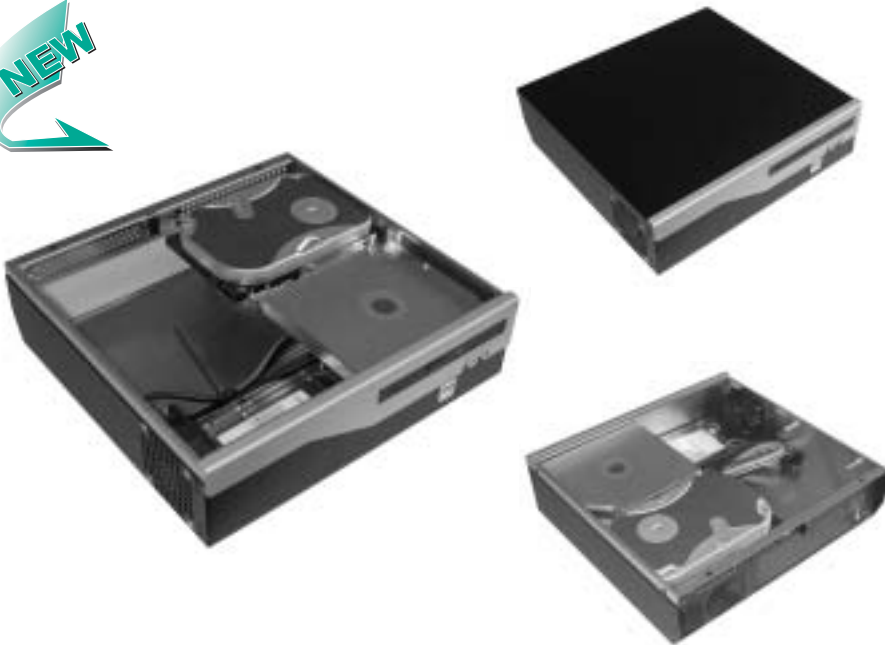

Specifications

- **Mounting:** Rack Mount or Wall Mount or Desktop
- **Construction:** Heavy Duty Cold Rolled Electroplated Steel
- **Color:** Black (Standard), Beige or Custom
- **Support Mini-ITX M/B (Max. to 6.7" x 6.7")**
- **Drive Capacity**
 - B05-1: 1xSlim CD-ROM & 4x2.5"HDD
 - B05-2: 1xSlim CD-ROM & 1x3.5"HDD & 2x2.5"HDD
 - B05-3: 8x2.5"HDD
 - B05-4: 2x2.5"HDD & 1x3.5"HDD
 - B05-5: 2x2.5"HDD & 2x3.5"HDD
- **Power Supply(Optional):** 1U Single 150~250W ATX PSU
- **Cooling:** 1x(60mm = 23.5CFM ea.) Fan
- **Expansion Slots:** 2 PCI Slot
- **Riser Card:** GHP-PC1106H (Optional)
- **Connector Port (Front):** 2x USB Ports
- **Indicators:** LEDs for Power ON/OFF, HDD Activity
- **Switch:** Power ON/OFF, System Reset
- **Dimensions (W x H x D):** 280 x 77 x 268mm (11" x 3" x 10.6")
- **Cuft:** 0.8
- **GW:** 3.4 kgs / 7.5 lbs
- **Carton Size(cm):** 37.3 x 17.5 x 36.3(14.7" x 6.9" x 14.3")
- **Humidity:** 5% - 95% Non-condensing

Dimension

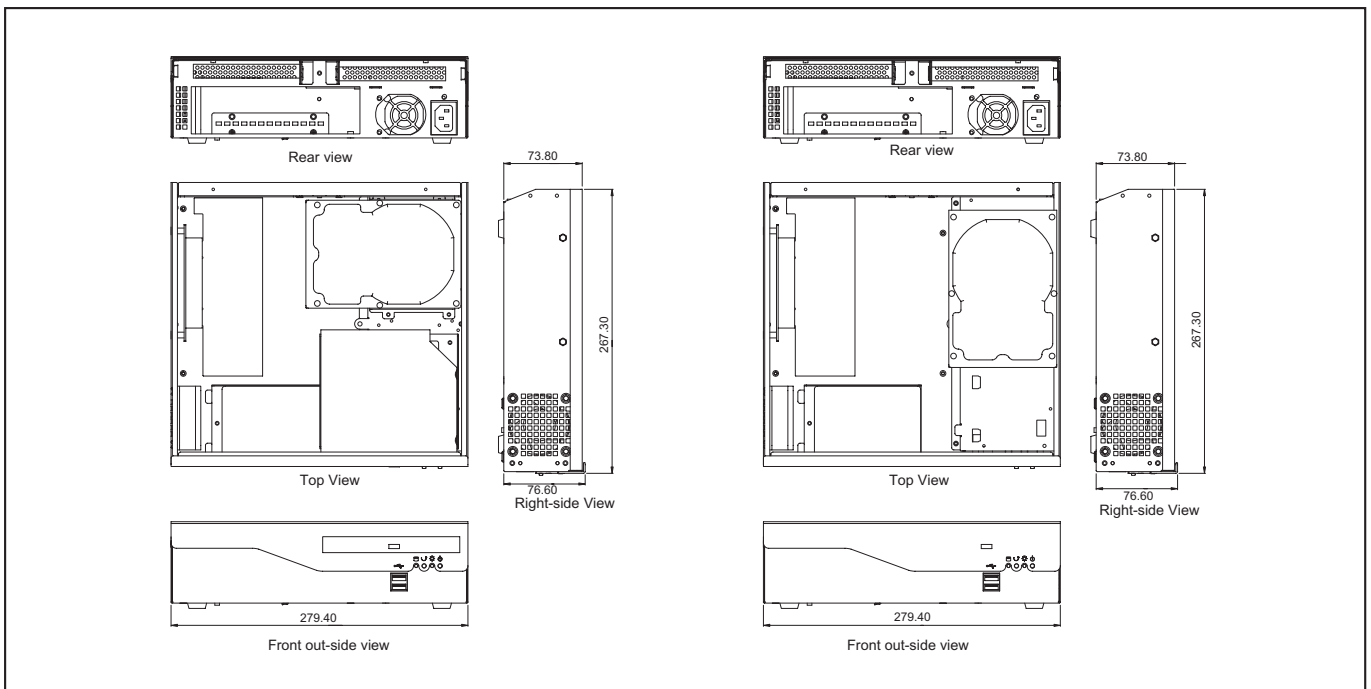

GHB-B08

6U-1/2 Rackmount Chassis



Specifications

- **Mounting:** Rack Mount
- **Construction:** Heavy Duty Cold Rolled Electroplated Steel
- **Color:** Black (Standard), Beige or Custom
- **Support 8-slot Passive Backplane**
- **Drive Capacity:** 1x5.25" & 1x3.5" & 1x3.5"HDD
- **Power Supply(Optional):** PS/2 Size Single 250~400W or Redundant 230~250W P/S(Rear Installation)
- **Connector Port (Front):** 1x PS/2 Port
- **Cooling:** Hot Swappable 2x(9cm) Fans(51CFM ea.) with Air Filter
- **Air Filter:** Inside Front Panel (Washable)
- **Indicators:** LEDs for Power ON/OFF, HDD Activity
- **Switch:** Power ON/OFF, System Reset
- **Dimensions (W x H x D):** 220 x 266 x 451mm (4.3" x 10.5" x 17.8")
- **Cuft:** 2.3
- **GW:** 10.0kgs / 22.1lbs
- **Carton Size(cm):** 57.0 x 31.2 x 36.4 (22.4" x 12.3" x 14.3")
- **Humidity:** 5% - 95% Non-condensing

Dimension

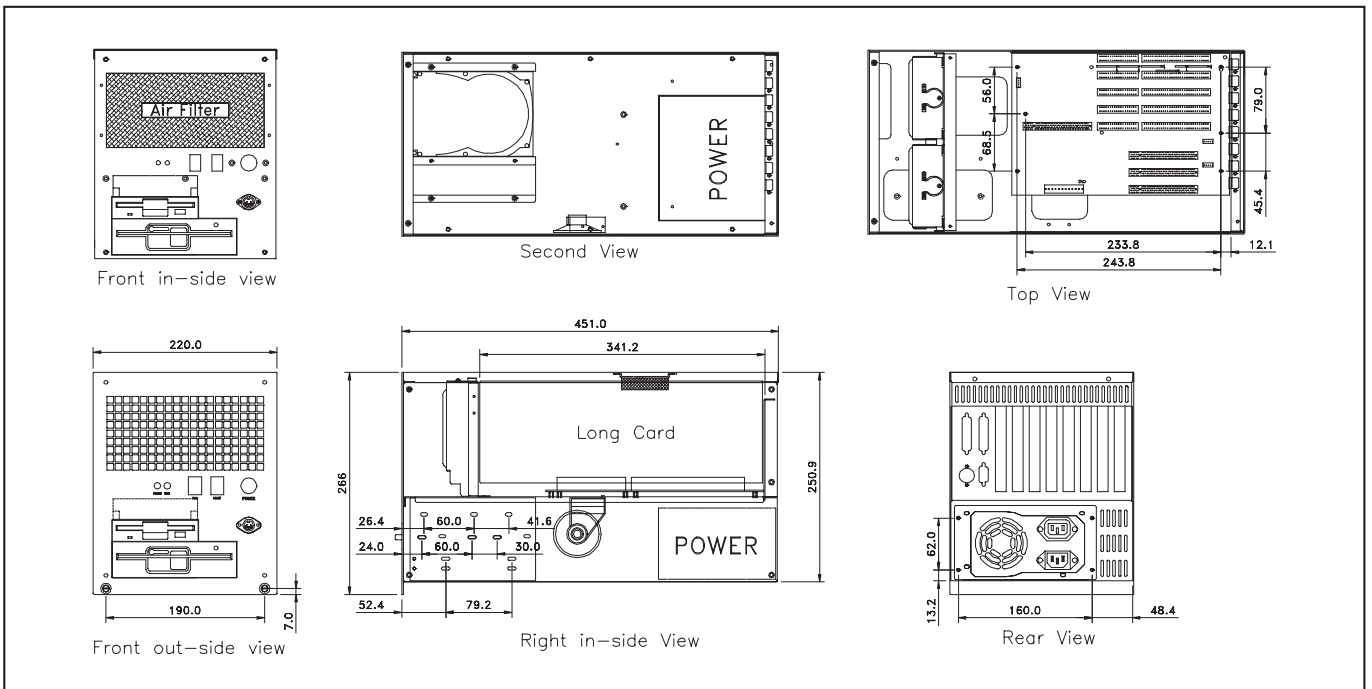

GHB-042

4-slot Micro Box Chassis



Specifications

- **Mounting:** Desktop or Wall Mount
- **Construction:** Heavy Duty Cold Rolled Electroplated Steel
- **Color:** Black (Standard), Beige or Custom
- **Supports 4-slot Passive Backplane**
- **Drive Capacity:** 1x 3.5" & 1x 3.5"HDD
- **Power Supply (Optional):** 1U Single up to 300W ATX P/S (Rear Installation) Max. Depth 205mm
- **Connector Port (Front):** 2x USB Ports
- **Cooling:** Hot Swappable 1x (92mm = 51CFM) Fan
- **Air Filter:** Inside Front Panel (Washable)
- **Indicators:** LEDs for Power ON/OFF, HDD Activity
- **Switch:** Power ON/OFF, System Reset
- **Dimensions(WxHxD):** 110x251x449mm(4.3"x9.9"x 17.7")
- **Cuft:** 1.5
- **GW:** 7.0kgs / 15.4lbs
- **Carton Size(cm):** 57 x 20 x 36.4 (22.4" x 7.9" x 14.3")
- **Humidity:** 5% - 95% Non-condensing

Dimension

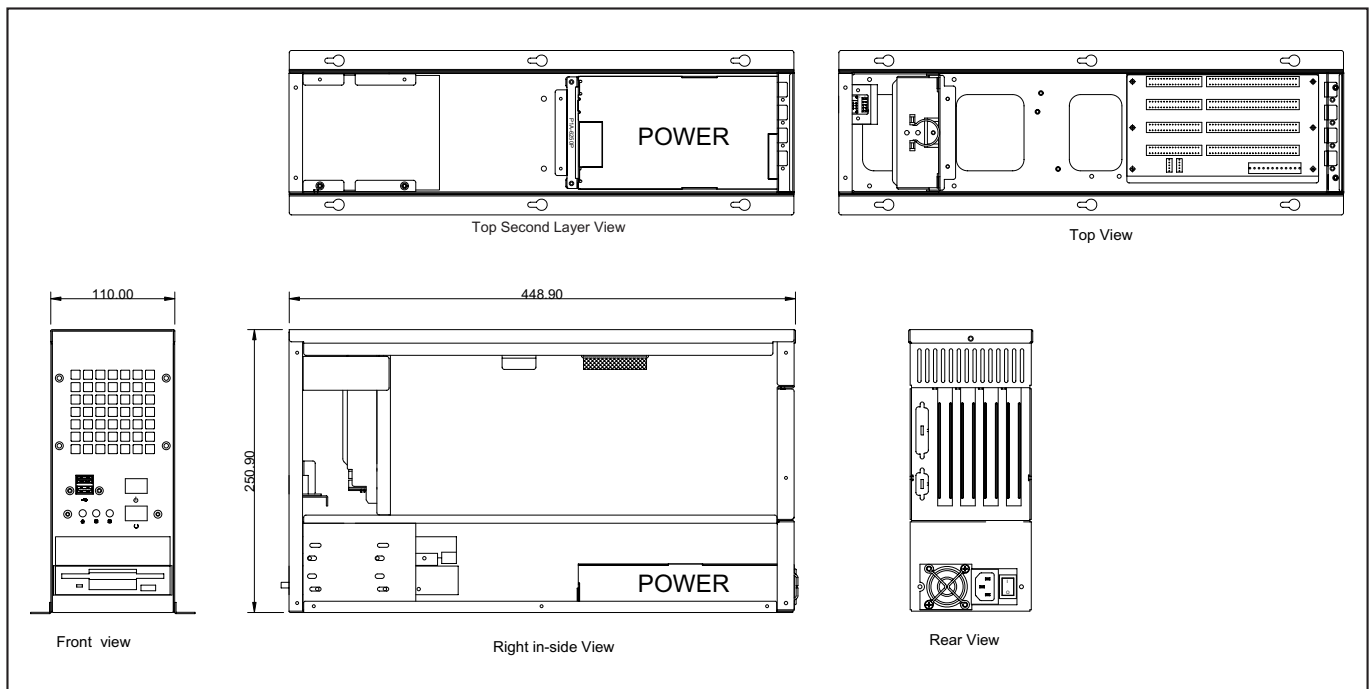

GHB-043

4-slot Micro Box Chassis



19" Rackmount

Specifications

- **Mounting:** Desktop or Wall Mount
- **Construction:** Heavy Duty Cold Rolled Electroplated Steel
- **Color:** Black (Standard), Beige or Custom
- **Supports 4-slot Passive Backplane**
- **Drive Capacity:** 1x 3.5 HDD & 1x 3.5 FDD & 1x 5.25 Slim CD-ROM
- **Power Supply (Optional):** 1U Single up to 300W ATX P/S
- **Connertor Port (Front):** 2xUSB Ports
- **Cooling:** 1x (92mm = 51CFM) Hot Swappable Fan & 1x (60mm = 23.5CFM) Fan
- **Air Filter:** Inside Front Panel (Washable)
- **Indicators:** LEDs for Power ON/OFF, HDD Activity
- **Switch:** Power ON/OFF, System Reset
- **Dimensions (W x H x D):** 160 x 220 x 260mm (6.3" x 8.6" x 10.2")
- **Cuft:** 0.9
- **GW:** 5.0kgs / 11lbs
- **Carton Size(cm):** 23.0x 29.0 x 36.5 (9.1" x 11.4" x 14.4")
- **Humidity:** 5% - 95% Non-condensing

Dimension

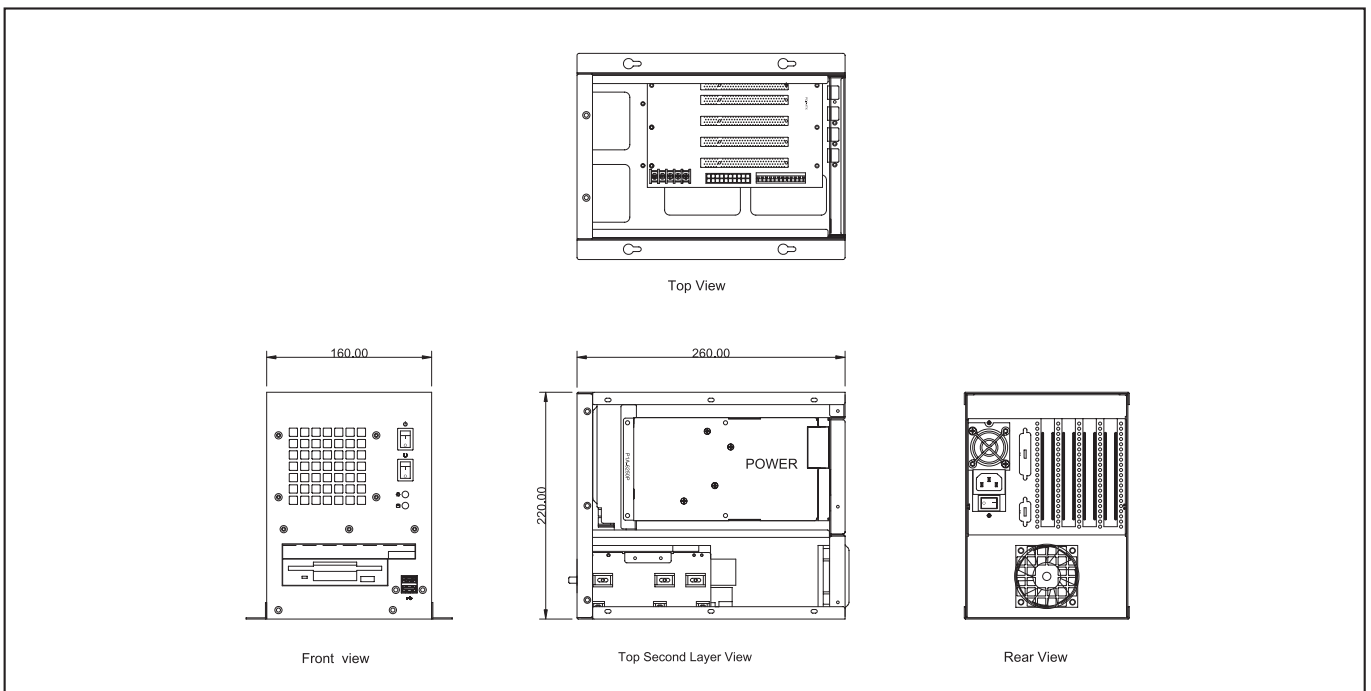

GHB-060

6-slot Micro Box Chassis

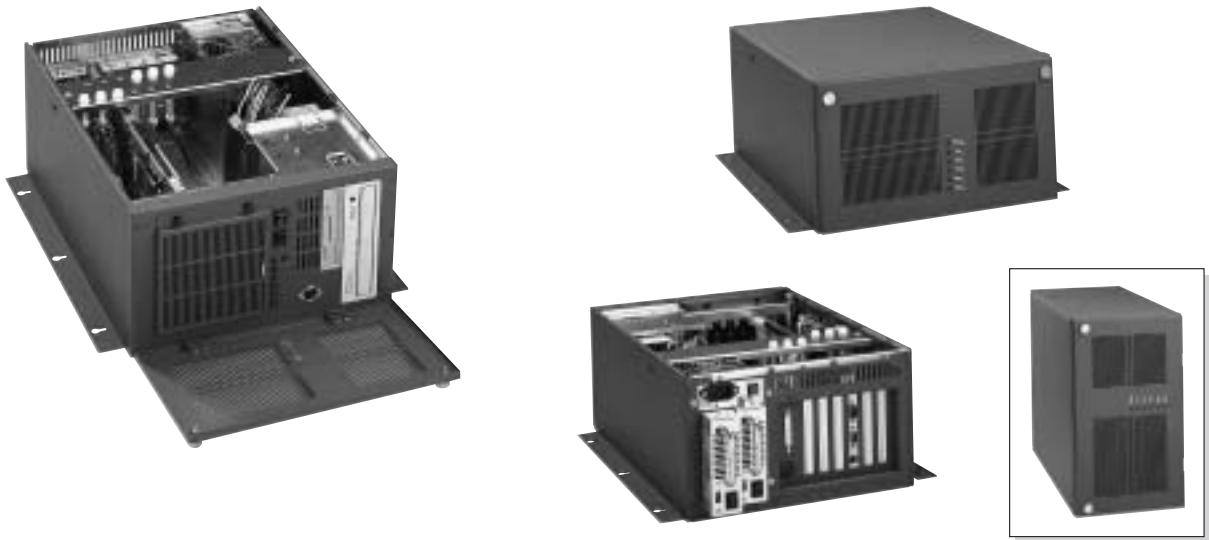

19" Rackmount

Specifications

- **Mounting:** Desktop or Wall Mount
- **Construction:** Heavy Duty Cold Rolled Electroplated Steel
- **Color:** Black (Standard), Beige or Custom
- **Support 6-slot Passive Backplane**
- **Drive Capacity:** 1x5.25" & 1x3.5"FDD & 1x3.5"HDD & 1x3.5"HDD(Optional)
- **Power Supply(Optional):** PS/2 Size Single up to 300W or Mini Redundant up to 300W ATX P/S (Rear Installation)
- **Cooling:** 1x(12cm) Fan(90CFM) with Removable Air Filter
- **Front Door:** Single Door with 2 Thumbscrews
- **Air Filter:** Inside Front Panel (Washable)
- **Connector Port (Front):** 1x PS/2 Port
- **Thermal Management Card:** GHA-CO01
- **Indicators:** LEDs for Power ON/OFF, HDD Activity, Fan, Temperature
- **Flexible Hold Down Bar Designed**
- **Switch:** Power ON/OFF, System Reset, Buzzer Reset
- **Dimensions(WxHxD):** 307x177x421mm(12" x 7.0" x 16.6")
- **Cuft:** 2.9
- **GW:** 12.0kgs / 26.5lbs
- **Carton Size(cm):** 45.5 x 32.4 x 55.8 (17.9" x 12.8" x 22.0")
- **Humidity:** 5% - 95% Non-condensin

Dimension

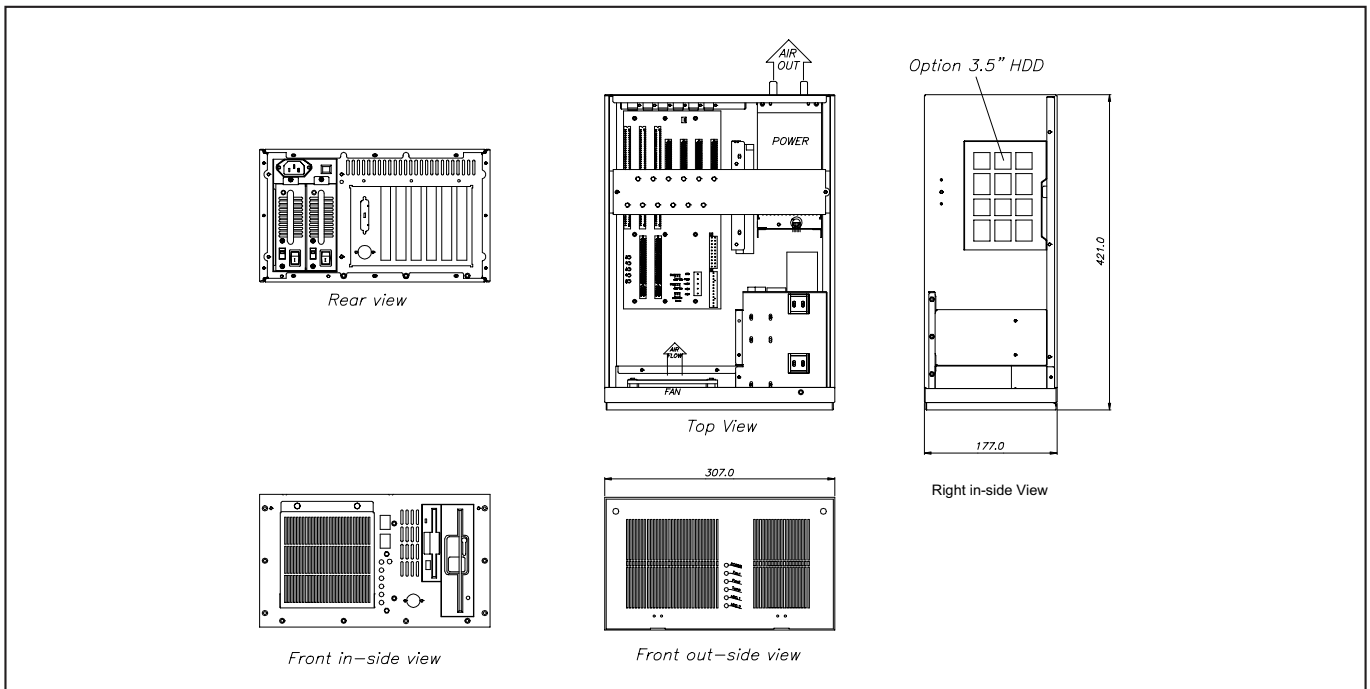

GHB-061

6-slot Micro Box Chassis



Specifications

- **Mounting:** Desktop or Wall Mount
- **Construction:** Heavy Duty Cold Rolled Electroplated Steel
- **Color:** Black (Standard), Beige or Custom
- **Support Flex ATX M/B and Micro ATX M/B**
- **Drive Capacity:** 1x5.25" & 1x3.5" & 1x3.5"HDD
- **Power Supply(Optional):** 1U Single 250~300W ATX P/S (Mid Installation)
- **Cooling:** 1x(9cm) Fan(51CFM) with Removable Air Filter
- **Front Door:** Single Door With 2 Thumbscrews
- **With Portable Handle**
- **Air Filter:** Inside Front Panel (Washable)
- **Connector Port(Front):** 2xUSB Ports
- **Thermal Management Card:** GHA-CO04
- **Indicators:** LEDs for Power ON/OFF, HDD Activity, Fan, Temperature
- **Flexible Hold Down Bar Designed**
- **Switch:** Power ON/OFF, System Reset, Buzzer Reset
- **Dimensions (WxHxD):** 307x177x421mm(12" x 7.0" x 16.6")
- **Cuft:** 2.9
- **GW:** 12.0kgs / 26.5lbs
- **Carton Size(cm):** 45.5x32.4x55.8 (17.9"x12.8"x 22.0")
- **Humidity:** 5% - 95% Non-condensing

Dimension

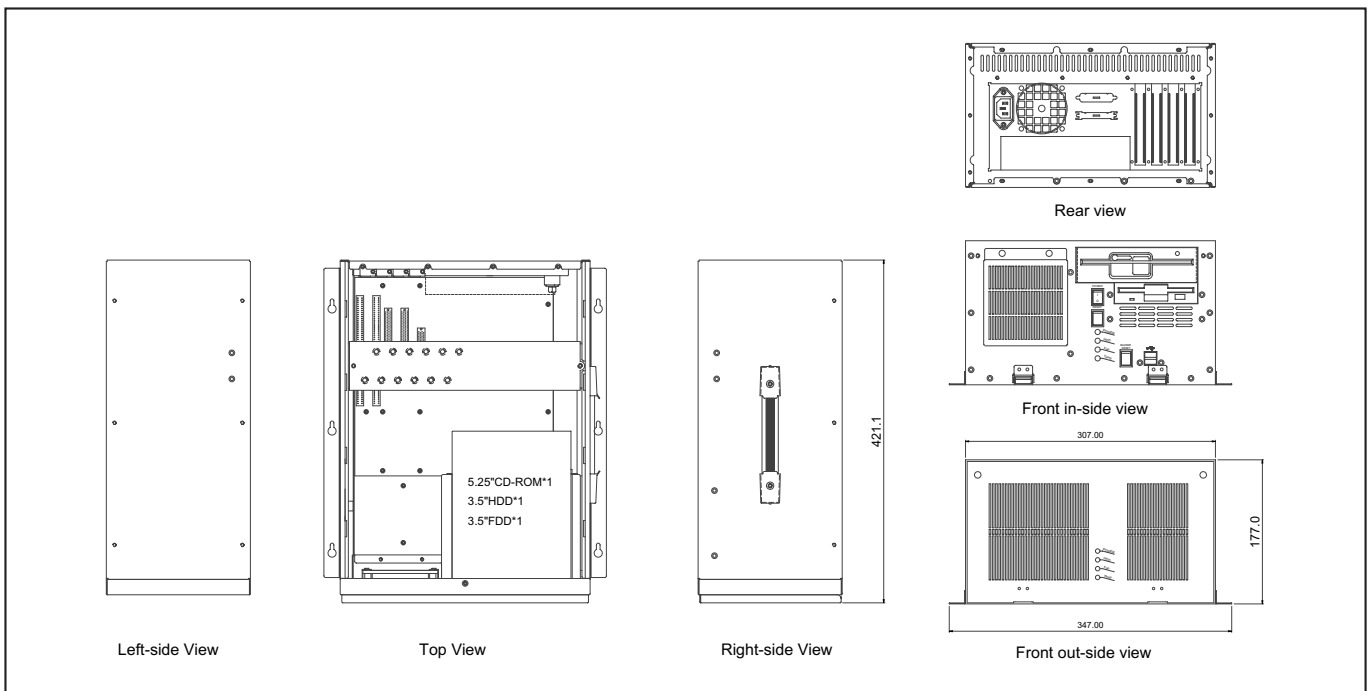

GHB-062-6

6-slot Micro Box Chassis



19" Rackmount

Specifications

- **Mounting:** Desktop or Wall Mount
- **Construction:** Heavy Duty Cold Rolled Electroplated Steel
- **Color:** Black (Standard), Beige or Custom
- **Supports 6-slot Passive Backplane**
- **Drive Capacity:** 1x 5.25", 1x 3.5" HDD, 1x 3.5" FDD, & 1x 3.5" HDD Bracket (Optional)
- **Power Supply (Optional):** PS/2 Size Single or Mini Redundant up to 300W ATX P/S
- **Cooling:** 1x (120mm = 90CFM) Fan
- **Air Filter:** Inside Front Panel (Washable)
- **Connector Port (Front):** 2x USB Ports
- **Thermal Management Card:** GHA-CO04
- **Indicators:** LEDs for Power ON/OFF, HDD Activity, Fan, Temperature
- **Flexible Hold Down Bar Designed**
- **Switch:** Power ON/OFF Momentary (Rocker), System Reset, Buzzer Reset
- **Dimensions (WxHxD):** 307x177x412 mm(12"x7.0"x16.2")
- **Cuft:** 2.9
- **GW:** 12.0kgs / 26.5lbs
- **Carton Size(cm):** 45.5 x 32.4 x 55.8 (17.9" x 12.8" x 22.0")
- **Humidity:** 5% - 95% Non-condensing

Dimension

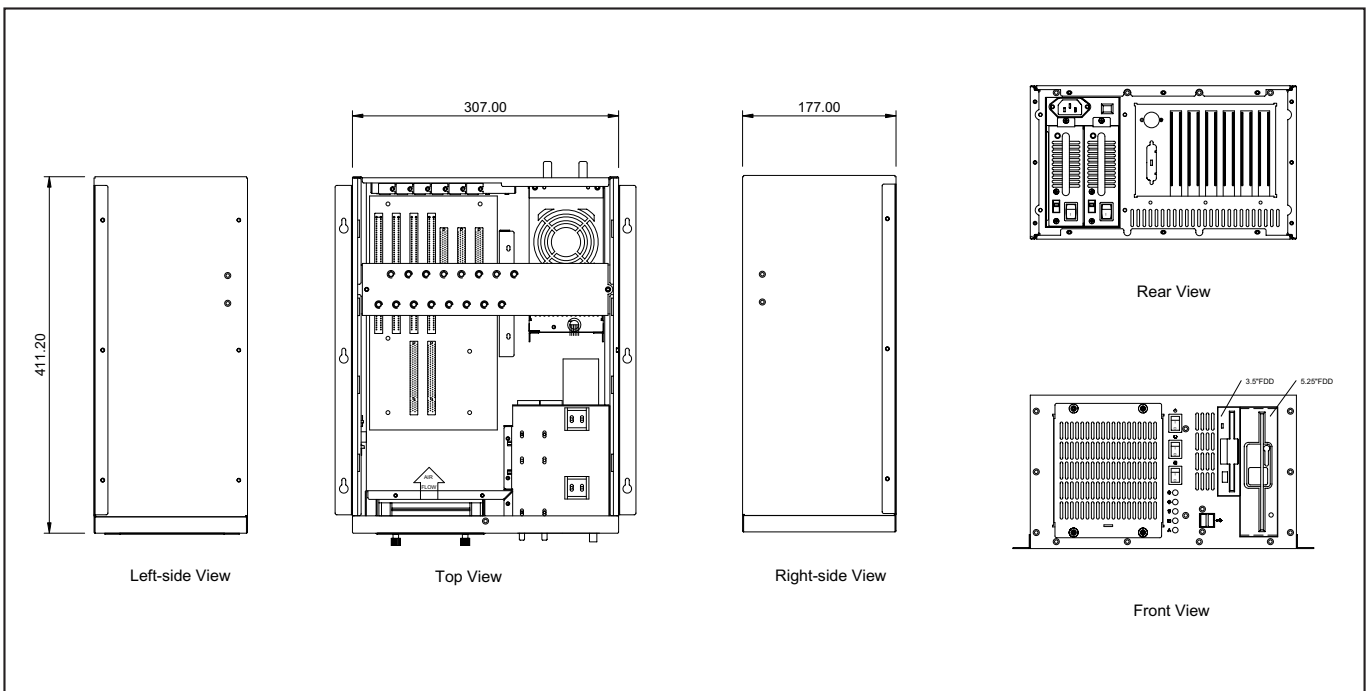

GHB-062-8

8-slot Micro Box Chassis



Specifications

- **Mounting:** Desktop or Wall Mount
- **Construction:** Heavy Duty Cold Rolled Electroplated Steel
- **Color:** Black (Standard), Beige or Custom
- **Supports 8-slot Passive Backplane**
- **Drive Capacity:** 1x 5.25" & 1x 3.5" FDD & 1x 3.5" HDD
- **Power Supply (Optional):** 1U Single up to 350W ATX P/S (Rear Installation) Max. Depth 225mm
- **Cooling:** 1x(12cm) Fan(90CFM) with Removable Air Filter
- **Air Filter:** Inside Front Panel (Washable)
- **Connector Port (Front):** 2x USB Ports
- **Thermal Management Card:** GHA-CO04
- **Indicators:** LEDs for Power ON/OFF, HDD Activity, Fan, Temperature
- **Flexible Hold Down Bar Designed**
- **Switch:** Power ON/OFF Momentary (Rocker), System Reset, Buzzer Reset
- **Dimensions(WxHxD):** 307x177x412 mm(12"x7.0"x16.2")
- **Cuft:** 2.9
- **GW:** 12.0kgs / 26.5lbs
- **Carton Size(cm):** 45.5 x 32.4 x 55.8 (17.9" x 12.8" x 22.0")
- **Humidity:** 5% - 95% Non-condensing

Dimension

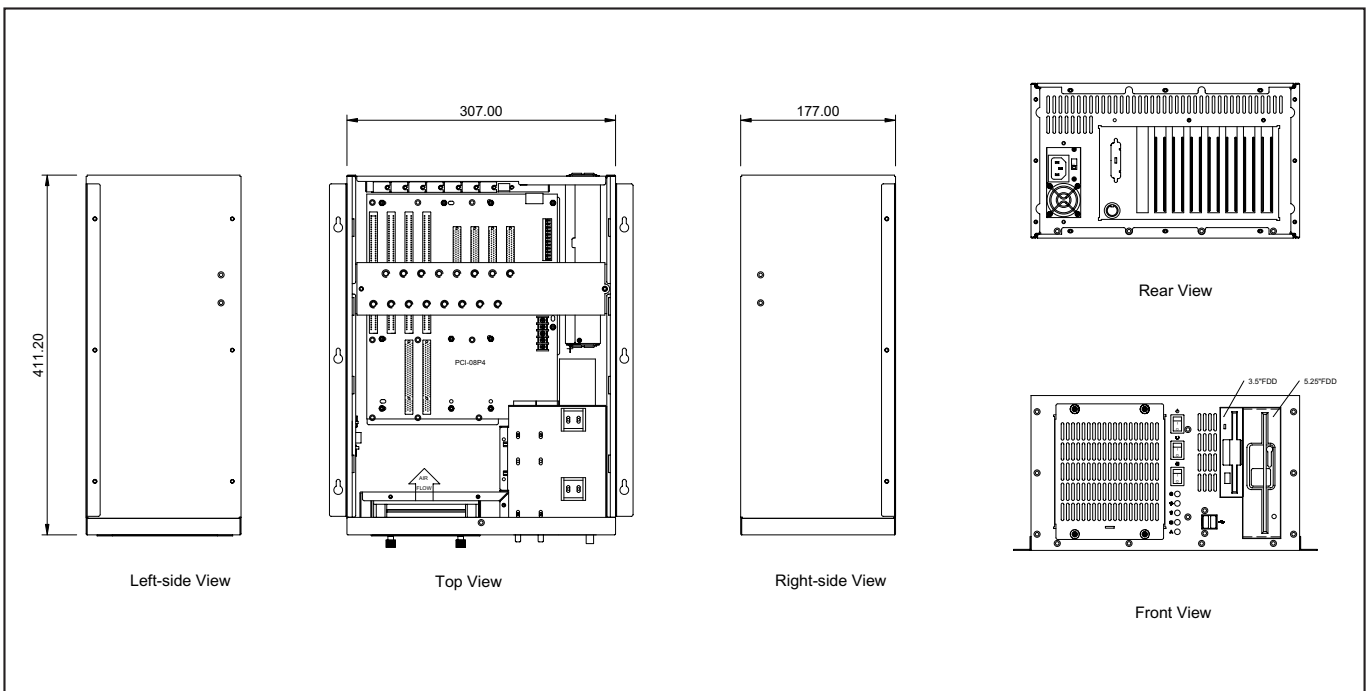

GHB-080

8-slot Micro Box Chassis

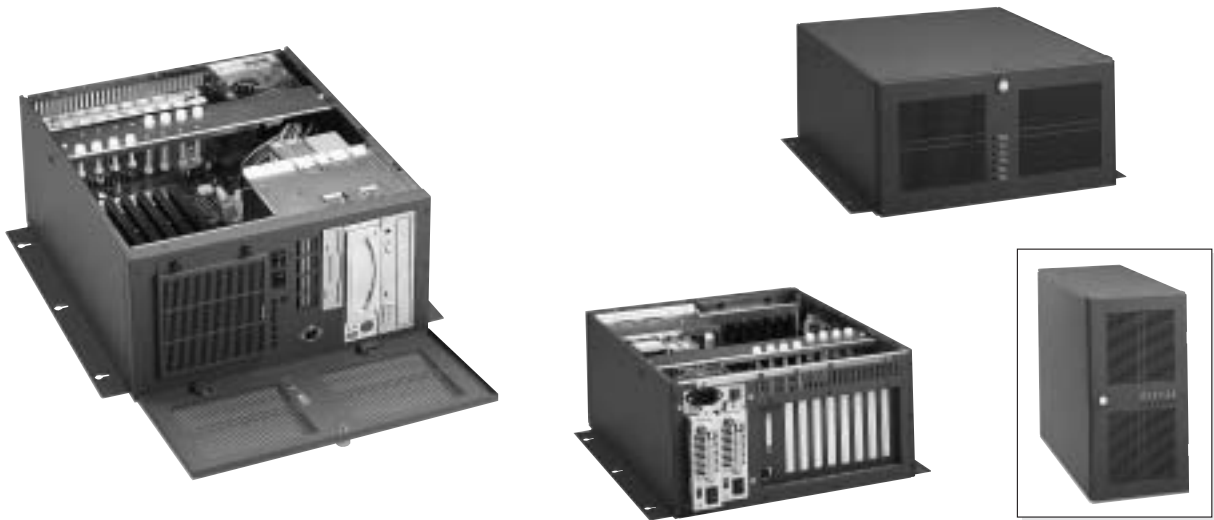

19" Rackmount

Specifications

- **Mounting:** Desktop or Wall Mount
- **Construction:** Heavy Duty Cold Rolled Electroplated Steel
- **Color:** Black (Standard), Beige or Custom
- **Support 8-slot Passive Backplane**
- **Drive Capacity:** 2x5.25" & 1x3.5" & 1x3.5"HDD
- **Power Supply(Optional):** PS/2 Size Single 250~400W or Redundant 230~400W P/S(Rear Installation) Max. Depth 225mm
- **Cooling:** 1x(12cm) Fan(90CFM) with Removable Air Filter
- **Front Door:** Single Door with 1 Thumbscrew
- **Air Filter:** Inside Front Danel (Washable)
- **Connector Port (Front):** 1x PS/2 Port
- **Thermal Management Card:** GHA-CO01
- **Indicators:** LEDs for Power ON/OFF, HDD Activity, Fan, Temperature
- **Flexible Hold Down Bar Designed**
- **Switch:** Power ON/OFF, System Reset, Buzzer Reset
- **Dimensions(WxHxD):** 350x177x421mm(13.8" x 7.0" x 16.6")
- **Cuft:** 3.1
- **GW:** 15.0kgs / 33.1lbs
- **Carton Size(cm):** 49.0 x 32.4 x 55.8(19.3" x 12.8" x 22.0")
- **Humidity:** 5% - 95% Non-condensing

Dimension

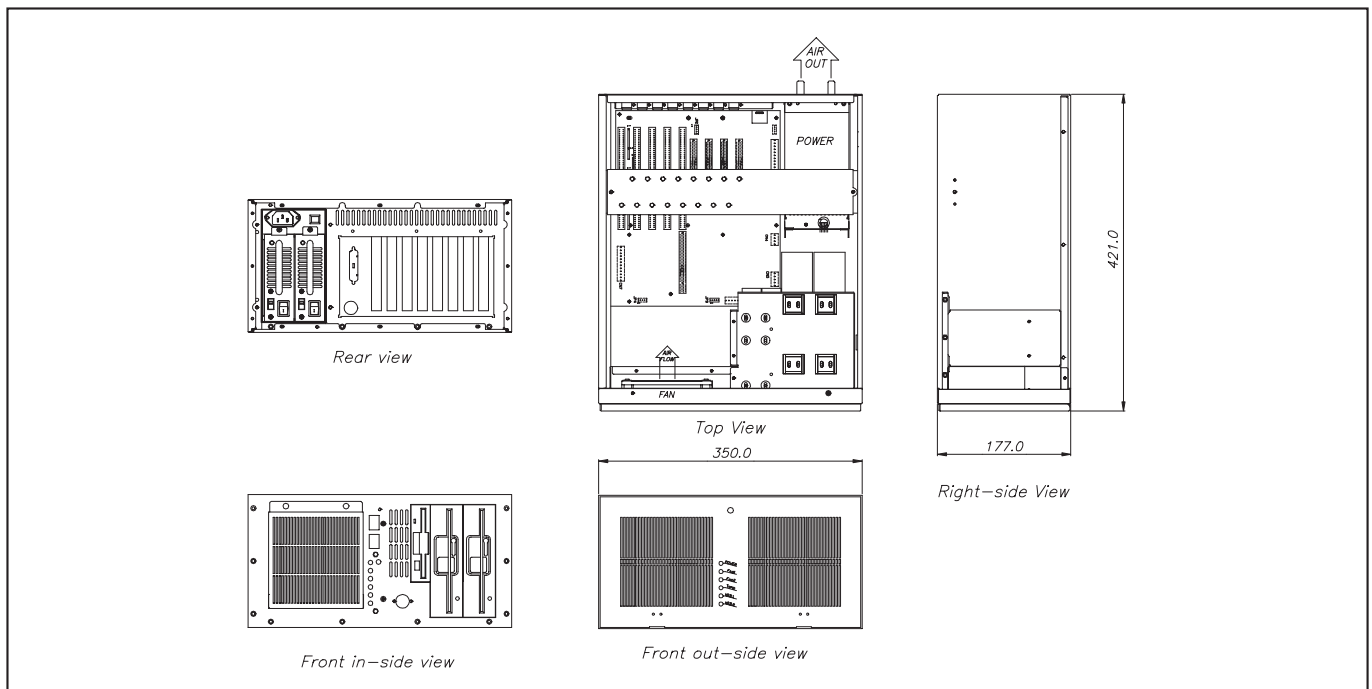

GHB-082-8

8-slot Micro Box Chassis



Specifications

- **Mounting:** Desktop or Wall Mount
- **Construction:** Heavy Duty Cold Rolled Electroplated Steel
- **Color:** Black (Standard), Beige or Custom
- **Support 8-slot Passive Backplane**
- **Drive Capacity:** 2x5.25" & 1x3.5" & 1x3.5"HDD
- **Power Supply(Optional):** PS/2 Size Single 250~400W or Redundant 230~400W P/S(Rear Installation) Max. Depth 225mm
- **Cooling:** 1x(12cm) Fan(90CFM) with Removable Air Filter
- **Without Front Door.**
- **Air Filter:** Inside Front Panel (Washable)
- **Connector Port (Front):** 2x USB Ports
- **Thermal Management Card:** GHA-CO04
- **Indicators:** LEDs for Power ON/OFF, HDD Activity, Fan, Temperature, LAN
- **Flexible Hold Down Bar Designed**
- **Switch:** Power ON/OFF, System Reset, Buzzer Reset
- **Dimensions (WxHxD):** 350x177x411mm(13.8"x7.0"x16.2")
- **Cuft:** 3.1
- **GW:** 15.0kgs / 33.1lbs
- **Carton Size(cm):** 49.0 x 32.4 x 55.8(19.3" x 12.8" x 22.0")
- **Humidity:** 5% - 95% Non-condensing

Dimension

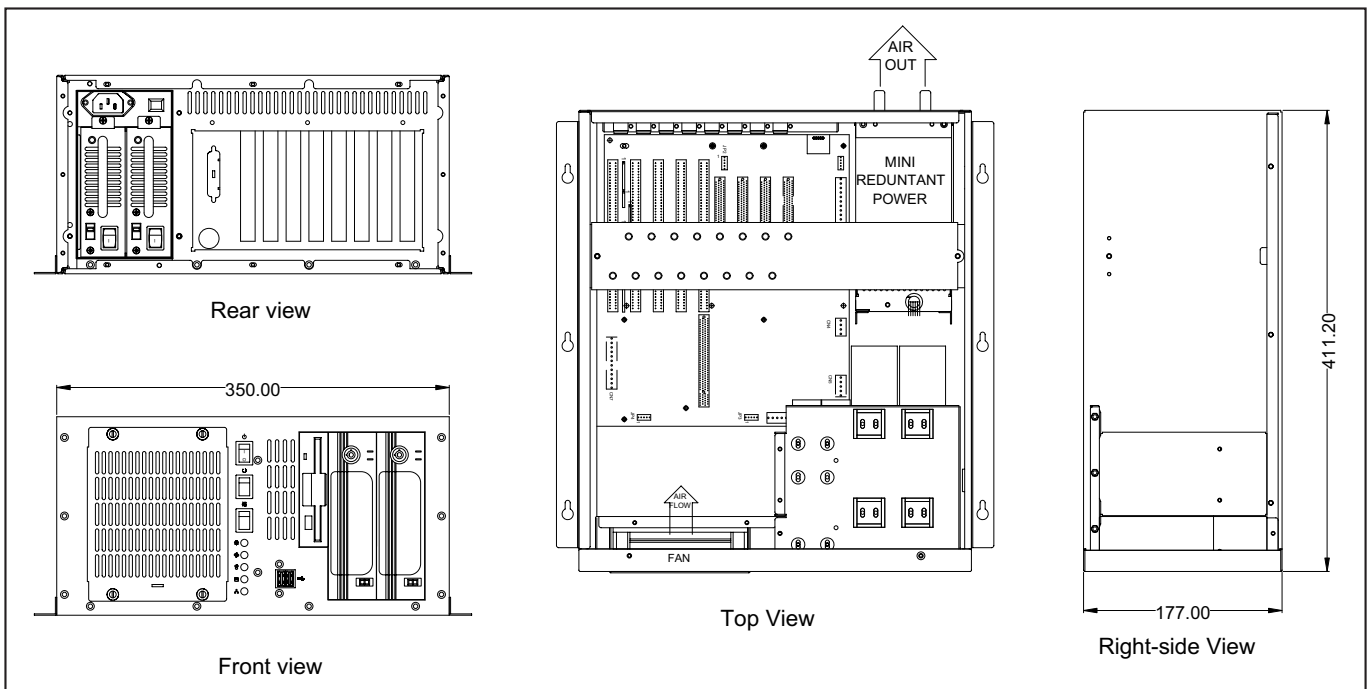

GHB-082-10

10-slot Micro Box Chassis



19" Rackmount

Specifications

- **Mounting:** Desktop or Wall Mount
- **Construction:** Heavy Duty Cold Rolled Electroplated Steel
- **Color:** Black (Standard), Beige or Custom
- **Support 10-slot Passive Backplane**
- **Drive Capacity:** 1x5.25" & 1x3.5" & 1x3.5"HDD
- **Power Supply(Optional):** 1U Size Single 250~300W P/S
- **Cooling:** 1x(12cm) Fan(90CFM) with Removable Air Filter
- **Without Front Door.**
- **Air Filter:** Inside Front Danel (Washable)
- **Connector Port (Front):** 2x USB Ports
- **Thermal Management Card:** GHA-CO04
- **Indicators:** LEDs for Power ON/OFF, HDD Activity, Fan, Temperature, LAN
- **Flexible Hold Down Bar Designed**
- **Switch:** Power ON/OFF, System Reset, Buzzer Reset
- **Dimensions (WxHxD):** 350x177x411mm(13.8"x7.0"x16.2")
- **Cuft:** 3.1
- **GW:** 15.0kgs / 33.1lbs
- **Carton Size(cm):** 49.0 x 32.4 x 55.8(19.3" x 12.8" x 22.0")
- **Humidity:** 5% - 95% Non-condensing

Dimension

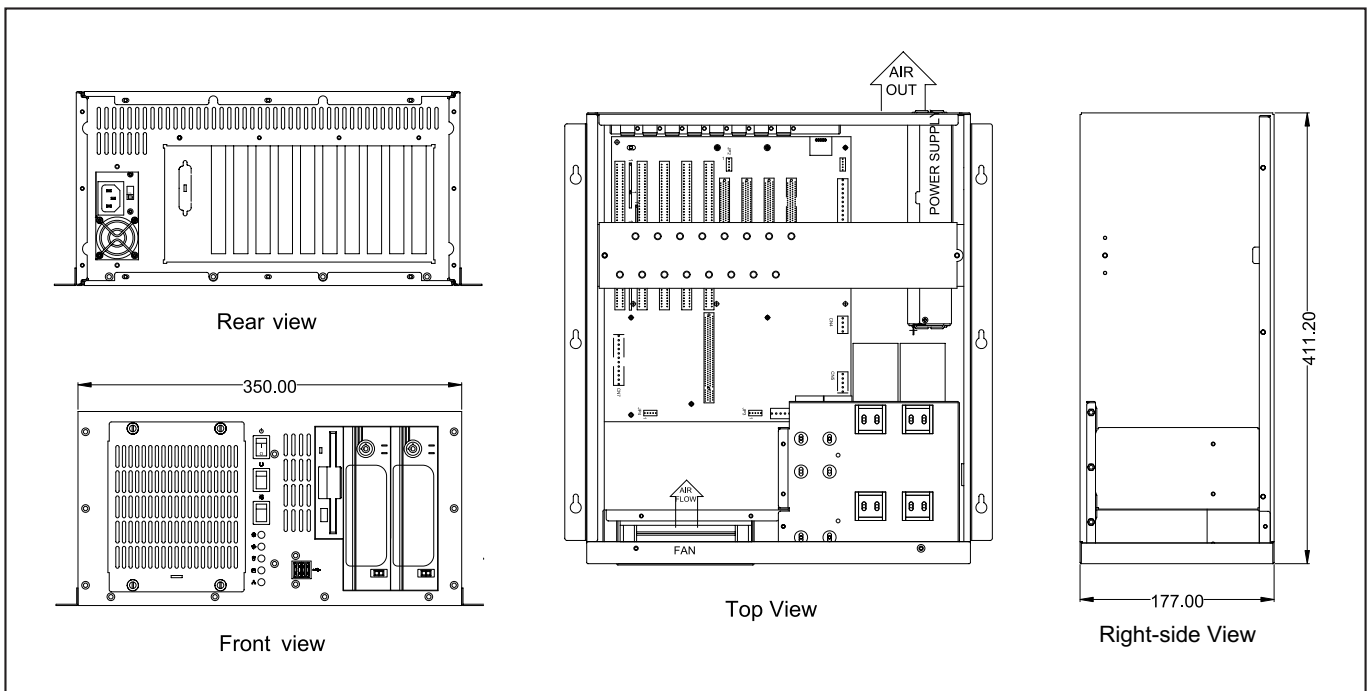

GHB-083-8

8-slot Micro Box Chassis



Specifications

- **Mounting:** Desktop or Wall Mount
- **Construction:** Heavy Duty Cold Rolled Electroplated Steel
- **Color:** Black (Standard), Beige or Custom
- **Support 8-slot Passive Backplane**
- **Drive Capacity:** 1x5.25" & 1x3.5" & 1x3.5"HDD
- **Power Supply(Optional):** 1U 200~300W P/S
- **Cooling:** 1x(12cm) Fan(90CFM) with Removable Air Filter
- **Air Filter:** Inside Front Panel (Washable)
- **Connector Port (Front):** 2x USB Ports
- **Indicators:** LEDs for Power ON/OFF, HDD Activity, LAN
- **Flexible Hold Down Bar Designed**
- **Switch:** Power ON/OFF, System Reset
- **Dimensions (WxHxD):** 280x237x260mm (11"x9.3"x10.2")
- **Cuft:** 2.3
- **GW:** 15.0kgs / 33.1lbs
- **Carton Size(cm):** 42.0x38.0x40.0(16.5"x15.0"x15.8")
- **Humidity:** 5% - 95% Non-condensing

Dimension

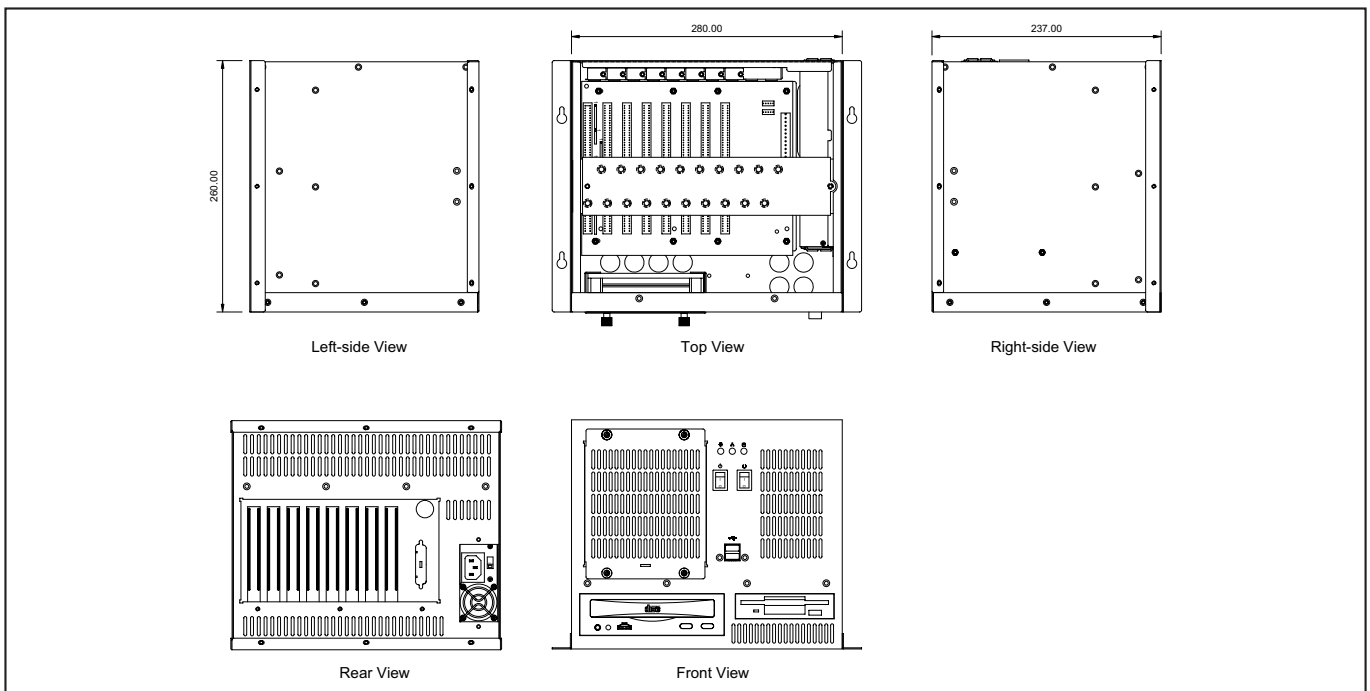

GHB-083-10

10-slot Micro Box Chassis

19" Rackmount



Specifications

- **Mounting:** Desktop or Wall Mount
- **Construction:** Heavy Duty Cold Rolled Electroplated Steel
- **Color:** Black (Standard), Beige or Custom
- **Support 10-slot Passive Backplane**
- **Drive Capacity:** 1x5.25" & 1x3.5" & 1x3.5"HDD
- **Power Supply(Optional):** 1U 200~300W P/S
- **Cooling:** 1x(12cm) Fan(90CFM) with Removable Air Filter
- **Air Filter:** Inside Front Panel (Washable)
- **Connector Port (Front):** 2x USB Ports
- **Indicators:** LEDs for Power ON/OFF, HDD Activity, LAN
- **Flexible Hold Down Bar Designed**
- **Switch:** Power ON/OFF, System Reset
- **Dimensions(WxHxD):** 280x237x260mm(11"x9.3"x10.2")
- **Cuft:** 2.3
- **GW:** 15.0kgs / 33.1lbs
- **Carton Size(cm):** 42.0x38.0x40.0(16.5"x15.0"x15.8")
- **Humidity:** 5% - 95% Non-condensing

Dimension

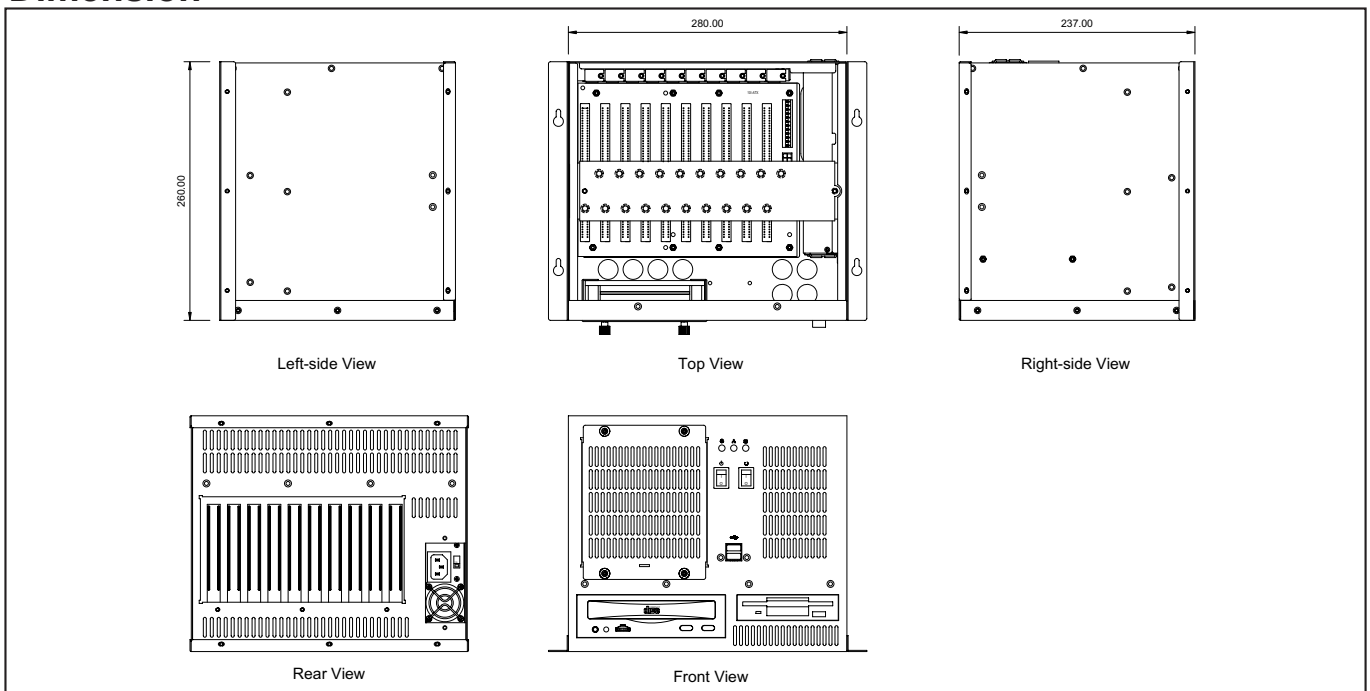

GHB-120ATXR/120SR

Micro Box Chassis

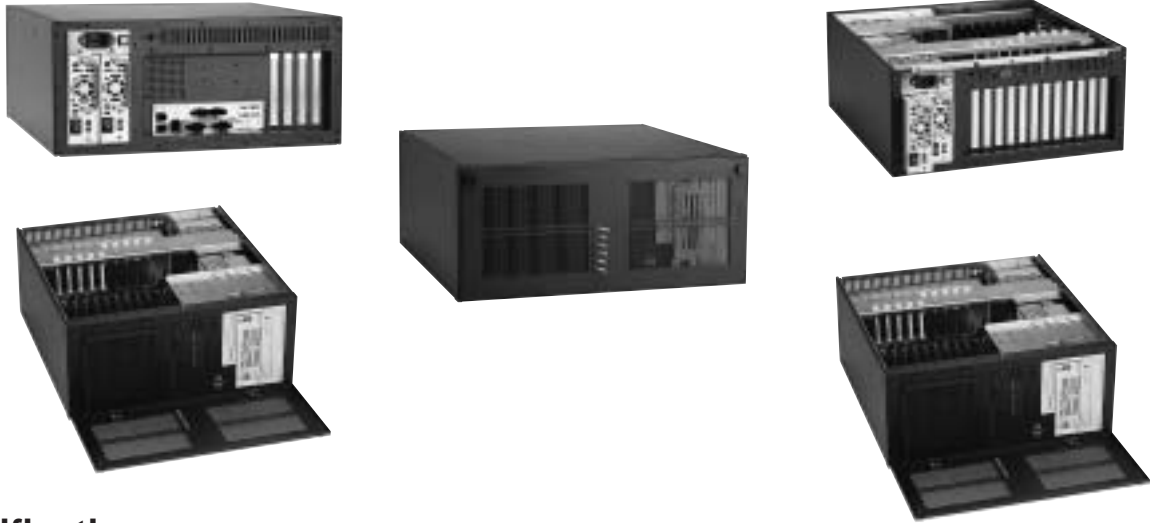

Specifications

- **Mounting:** Desktop or Wall Mount
- **Construction:** Heavy Duty Cold Rolled Electroplated Steel
- **Color:** Black (Standard), Beige or Custom
- **Support Flex ATX M/B and Micro ATX M/B(120ATXR)**
- **Support 10/12-slot Passive Backplane(9 Full Length Card)(120SR)**
- **Drive Capacity:** 2x5.25" & 2x3.5" & 1x3.5"HDD
- **Power Supply(Optional):** PS/2 Size Single up to 400W or Redundant up to 300W ATX P/S (Rear Installation) Max. Depth 225mm
- **Cooling:** 1x(12cm) Fan(90CFM) with Removable Air Filter
- **Front Door:** Single Door with 2 Thumbscrews
- **Air Filter:** Inside Front Panel (Washable)
- **Thermal Management Card:** GHA-CO01
- **Indicators:** LEDs for Power ON/OFF, HDD Activity, Fan, Temperature
- **Flexible Hold Down Bar Designed**
- **Switch:** Power ON/OFF, System Reset, Buzzer Reset
- **Dimensions (WxHxD):** 400x177x420mm(15.7"x7.0"x16.5")
- **Cuft:** 3.6
- **GW:** 15.0kgs / 33.1lbs
- **Carton Size(cm):** 56.1 x 33.0 x 54.8(22.1" x 13.0" x 21.6")
- **Humidity:** 5% - 95% Non-condensing

Dimension

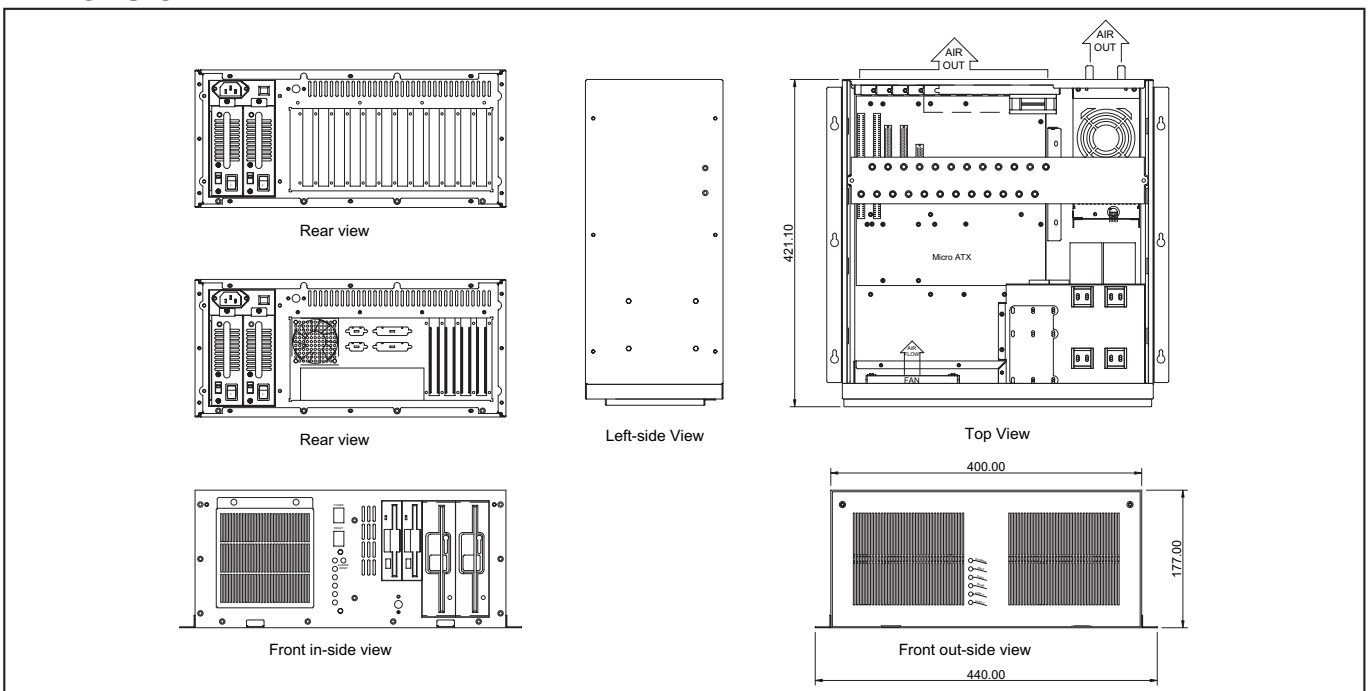

GH-M15/M17

Monitor Enclosure

19" Rackmount



Specifications

- EIA RS-310C 19" Rackmount Standard
- Universal Solution for Mounting 15" (M15) or 17" (M17) Monitor
- Form Factor: GH-M15 = 8U, GH-M17 = 10U
- Color: Black (Standard), Beige or Custom
- Screen Size: 305x299mm(M15), 345x260mm(M17)
- Dimensions(WxHxD):
 - 483x355x460mm(19"x14.0"x18.1")(M15)
 - 483x444x460mm(19"x17.5"x18.1")(M17)
- Cuf: 2.2
- GW: 12.0kgs / 26.5 lb(M15), 13.0kgs / 28.6lbs(M17)
- Carton Size(cm): 65.4 x 15.2 x 62.4(25.8" x 6.0" x 24.6")

Dimension

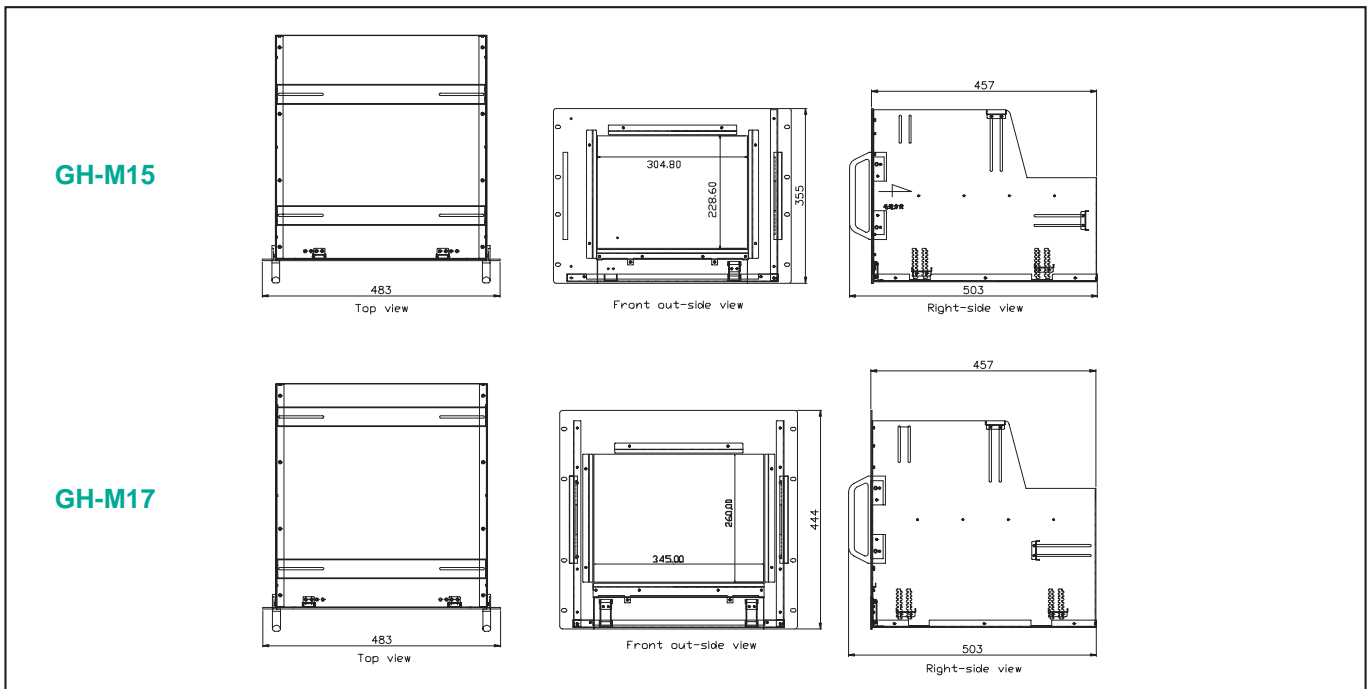

GHK-M01

1U 15" LCD Monitor

19" Rackmount



Specifications

- **EIA RS-310C 19" Rackmount Standard**
- **Construction:** Heavy Duty Cold Rolled Electroplated Steel
- **Color:** Black (Standard) or Beige
- **LCD Size:** 15" TFT with 1024x768 Resolution
- **LCD Quality:** Luminance(250 cd/m²)
- **Keyboard:** 83/84 Key with Integrated Track Ball + 2 Mouse Buttons
- **Power Supply:** 12V/48W, 100~240V Auto Ranging PSU
- **Key Lock:** Yes
- **Indicators:** LED for Power
- **Switch:** Power ON/OFF, Brightness, Contrast, Menu
- **Dimensions(WxHxD):** 483x44x520mm(19"x1.7"x20.2")
- **Cuft:** 4.1
- **GW:** 20.0kgs / 44.1lbs
- **Carton Size(cm):** 75.1x23.3x67.0(29.6"x9.2"x26.4")
- **Humidity:** 5% - 95% Non-condensing

Dimension

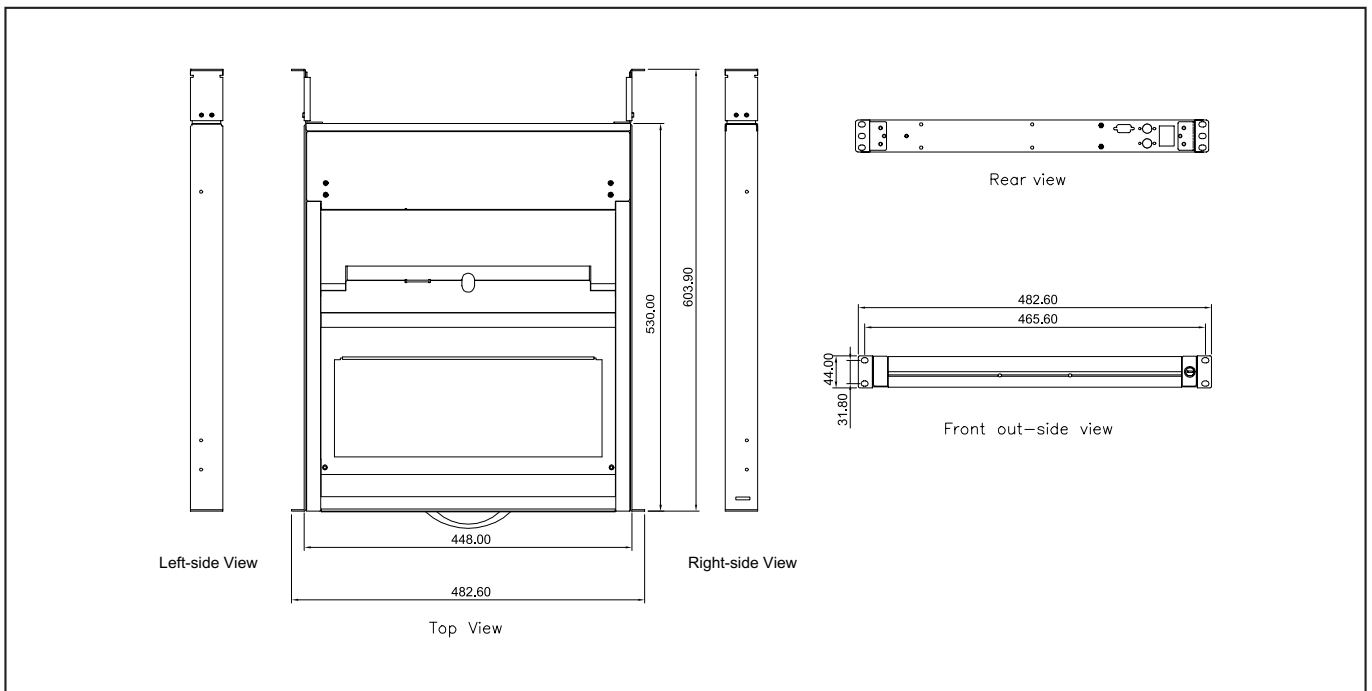

GHK-M02

1U 15" LCD Monitor with 8-ports KVM



19" Rackmount

Specifications

- **EIA RS-310C 19" Rackmount Standard**
- **Construction:** Heavy Duty Cold Rolled Electroplated Steel
- **Color:** Black (Standard), Beige or Custom
- **LCD Size:** 15" TFT with 1024x768 Resolution
- **LCD Quality:** Luminance(250 cd/m²)
- **Keyboard:** 83/84 Key with Integrated Track Ball + 2 Mouse Buttons
- **Power Supply:** 12V/48W, 100~240V Auto Ranging PSU
- **Key Lock:** Yes
- **Indicators:** LED for Power
- **Switch:** Power ON/OFF, Brightness, Contrast, Menu
- **KVM:** 8 Ports
- **Dimensions(WxHxD):** 483x44x520mm(19"x1.7"x20.2")
- **Cuft:** 4.1
- **GW:** 22.0kgs / 48.5lbs
- **Carton Size(cm):** 75.1x23.3x67.0(29.6"x9.2"x26.4")
- **Humidity:** 5% - 95% Non-condensing

Dimension

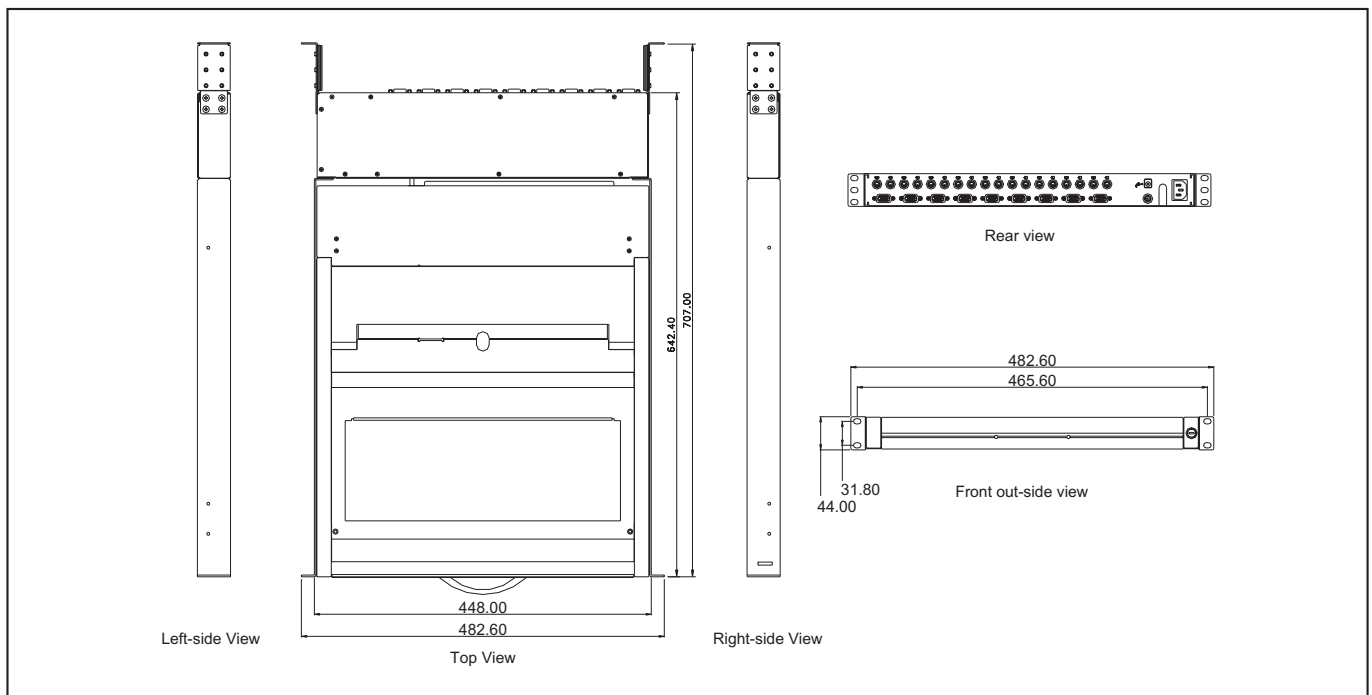

GH-K02



Specifications

- EIA RS-310C 19" 1U Rackmount Keyboard Drawer
- 104 Keys PS2 Keyboard
- Color: Beige or Black
- Rugged Sliding Rails with Handles & Key Lock
- Mouse Pad & Storage compartment
- Dimensions: 483(W)x44(H)x460(D)mm (19"x1.7"x18.1")
- Cuft: 1.3
- GW: 8.5kgs / 18.7lbs
- Carton Size(cm): 57.3x11.0x59.4 (22.6"x4.3"x23.4")

GH-KD1



Specifications

- EIA RS-310C 19" 1U Rackmount Keyboard Drawer
- Special Design for Cherry "G80-11900" Keyboard (Optional)
- Color: Beige or Black
- Rugged Sliding Rails with Handles & Key Lock
- Dimensions: 483(W)x44(H)x460(D)mm (19"x1.7"x18.1")
- Cuft: 1.3
- GW: 6.0kgs / 13.2lbs
- Carton Size(cm): 57.3x11.0x59.4 (22.6"x4.3"x23.4")

GH-KD4



Specifications

- EIA RS-310C 19" 1U Rackmount Keyboard Drawer
- Special Design for Cherry "G84-4400" Keyboard (Optional)
- Color: Beige or Black
- Rugged Sliding Rails with Handles & Key Lock
- Dimensions: 483(W)x44(H)x460(D)mm (19"x1.7"x18.1")
- Cuft: 1.3
- GW: 8.0kgs / 17.6lbs
- Carton Size(cm): 57.3x11.0x59.4 (22.6"x4.3"x23.4")

GHC-C01

1U Compact PCI



Specifications

- **EIA RS-310C 19" Rack-mount Standard**
- **Construction:** Rittal System & Heavy Duty Cold Rolled Electroplated Steel
- **Color:** Black (Standard), Beige or Custom
- **Support:** 2-slot 64bit 6U cPCI Backplane with H.110 Compatible Pin Assignments on Peripheral Slot
- **Power Supply(Optional):** 1U Single up to 400W ATX P/S (Rear Installation) Max. Depth 250mm
- **Cooling:** 4x(4cm) Fans(10.8CFM ea.)
- **Indicators:** LEDs for Power ON/OFF
- **Switch:** Power ON/OFF, System Reset
- **Dimensions (W x H x D):** 483x44x323mm(19"x1.7"x12.7")
- **Cuft:** 1.7
- **GW:** 7.7kgs / 17.0 lbs
- **Carton Size(cm):** 593x445x181(23.4"x17.5"x7.1")
- **Product Applications:** High end Firewall , VPN ,IDS ,Traffic Management

Dimension

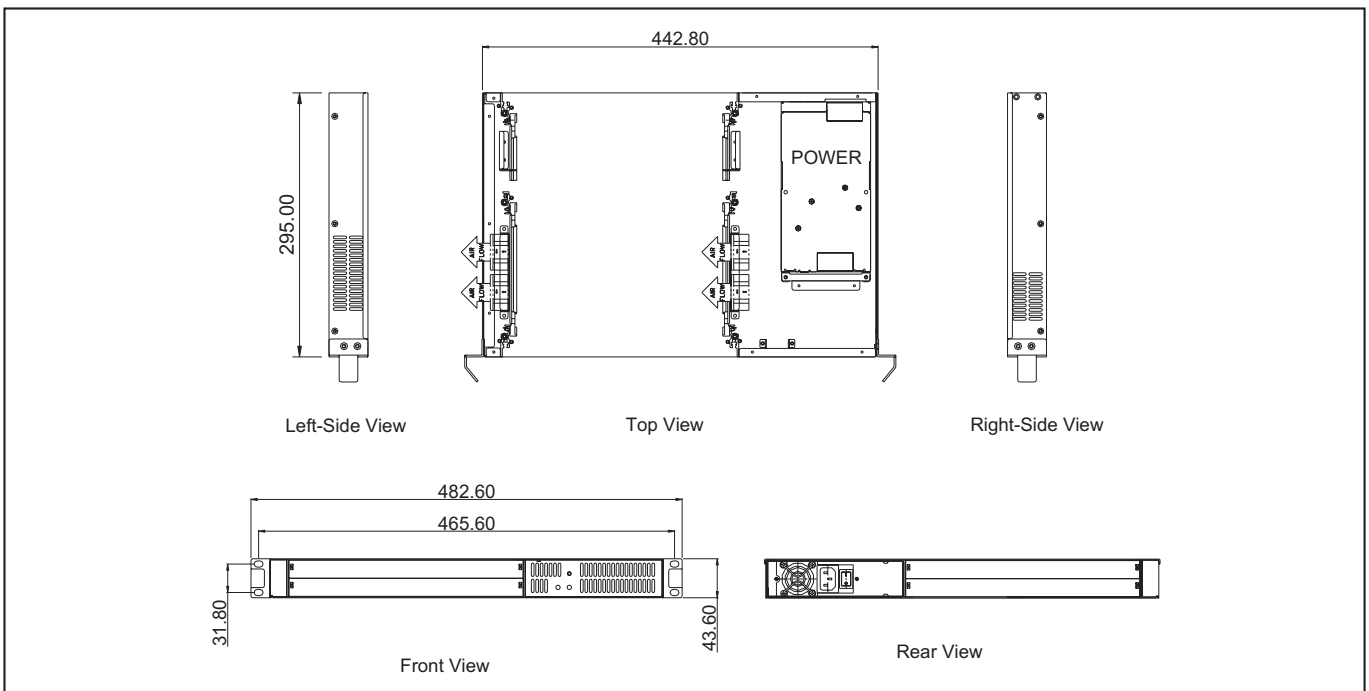

GHC-C02

2U Compact PCI



Specifications

- **EIA RS-310C 19" Rack-mount Standard**
- **Construction:** Rittal System & Heavy Duty Cold Rolled Electroplated Steel
- **Color:** Black (Standard), Beige or Custom
- **Support:** 4-Slot 64 bit 6U cPCI Backplane with H.110 Compatible pin Assignment on Peripheral Slot
- **Drive Capacity:** 1x3.5" Swappable Trays
- **Power Supply(Optional):** 1U Single up to 400W ATX P/S (Rear Installation) Max. Depth 250mm
- **Cooling:** 2x(8cm) Fans(42.5CFM ea.)
- **Indicators:** LEDs for Power ON/OFF
- **Switch:** Power ON/OFF, System Reset
- **Dimensions (W x H x D):** 483x88x295mm(19"x3.5"x11.6")
- **Cuft:** 2.1
- **GW:** 10.1kgs / 22.3 lbs
- **Carton Size(cm):** 593x445x226(23.4"x17.5"x8.9")
- **Product Applications:** High end Firewall , VPN ,IDS ,Traffic Management, Telecom

Dimension

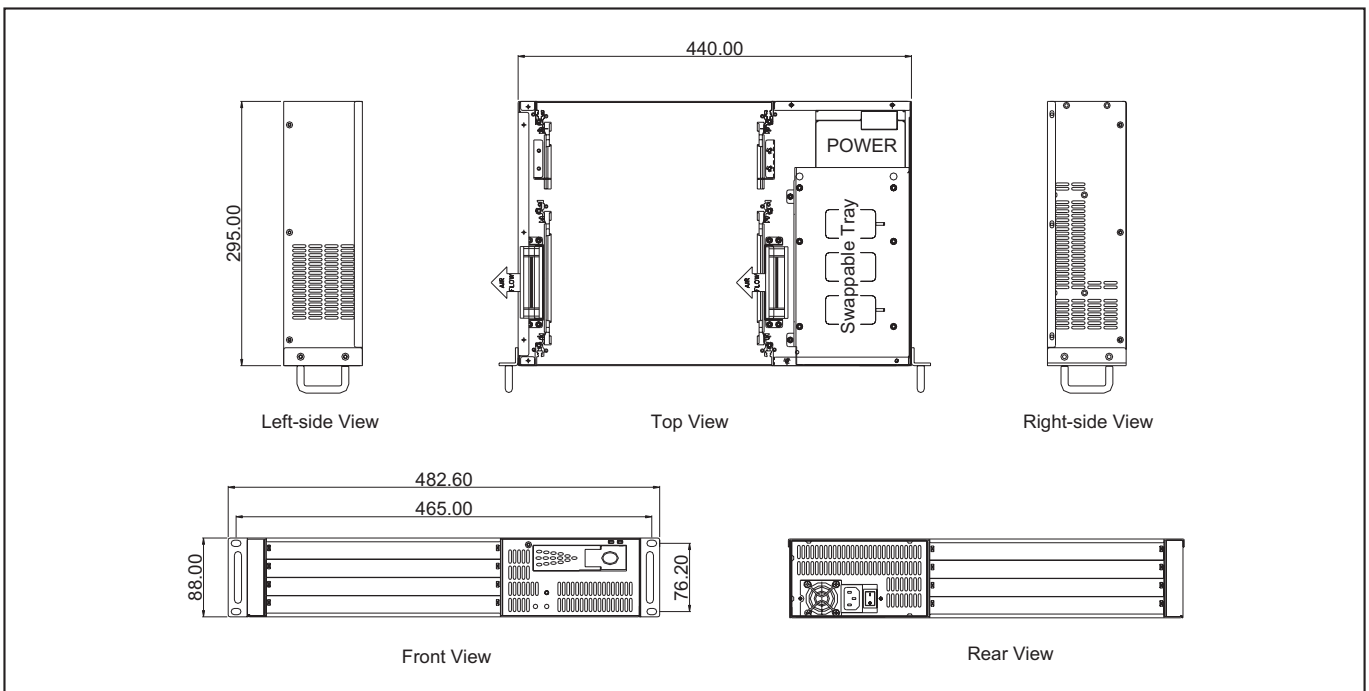

GHC-C03

3U Compact PCI



Specifications

- **EIA RS-310C 19" Rack-mount Standard**
- **Construction:** Rittal System & Heavy Duty Cold Rolled Electroplated Steel
- **Color:** Black (Standard), Beige or Custom
- **Support:** 5-slot 32/64 bit 6U cPCI H.110 Bus Backplane
- **Drive Capacity:** 1xSlim CD-ROM & 1xSlim FDD & 1x3.5" Swappable Trays
- **Power Supply(Optional):** 2U Single 300W~320W ATX P/S
- **Cooling:** 1x(8cm) (42.5CFM) & 1x(9cm) (51CFM) Fans
- **Indicators:** LEDs for Power ON/OFF
- **Switch:** Power ON/OFF, System Reset
- **Dimensions(WxHxD):**483x133x296.2mm(19"x5.2"x11.7")
- **Cuft:** 2.5
- **GW:** 12.4kgs / 27.3 lbs
- **Carton Size(cm):** 593x445x269(23.4"x17.5"x10.6")
- **Product Applications:** High end Firewall , VPN ,IDS ,Traffic Management, Telecom

Dimension

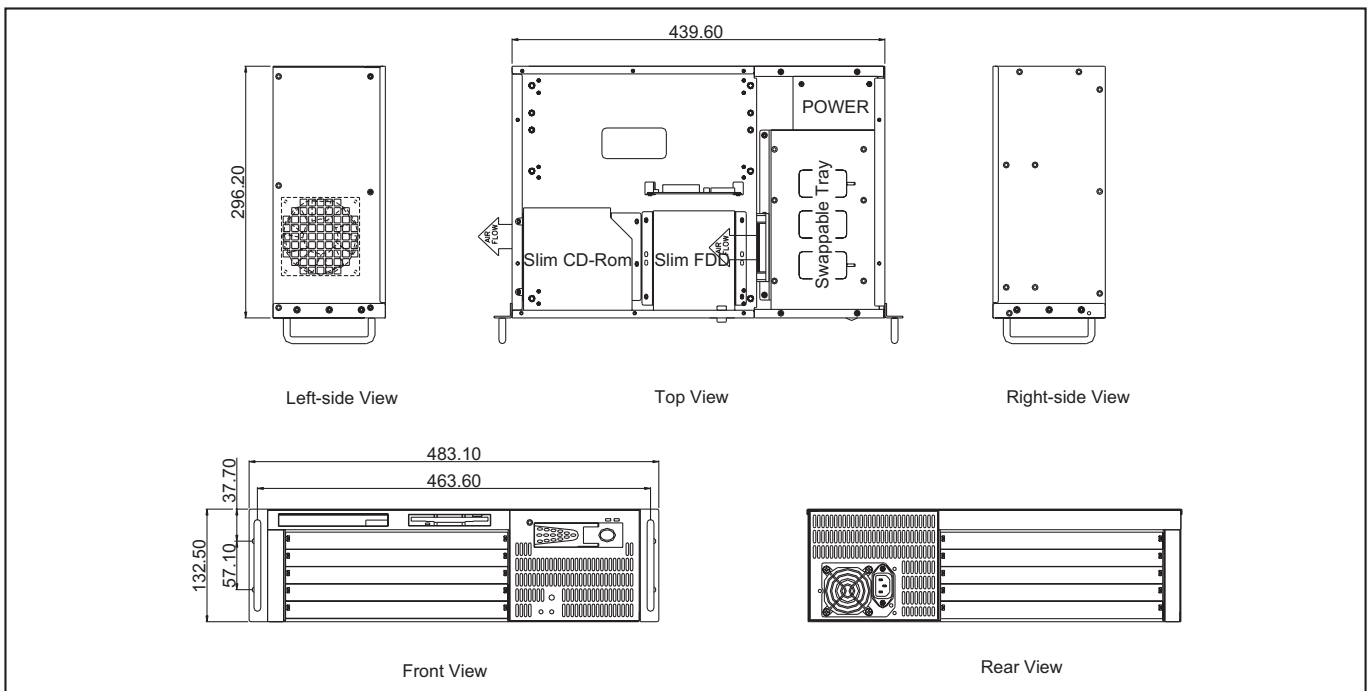

GHC-C04

4U Compact PCI



Specifications

- **EIA RS-310C 19" Rack-mount Standard**
- **Construction:** Rittal System & Heavy Duty Cold Rolled Electroplated Steel
- **Color:** Black (Standard), Beige or Custom
- **Support:** 7-slot 32/64 bit 6U cPCI H.110 Bus Backplane
- **Drive Capacity:** 1xSlim CD-ROM & 1xSlim FDD & 2x3.5" Swappable Trays
- **Power Supply(Optional):** 2U Single 300W~320W ATX P/S
- **Cooling:** 1x(8cm) (42.5CFM) & 2x(9cm) (51CFM ea.) Fans
- **Indicators:** LEDs for Power ON/OFF
- **Switch:** Power ON/OFF, System Reset
- **Drive Capacity:** 483x177x296mm(19"x7.0"x11.7")
- **Cuft:**2.9
- **GW:** 14.7kgs / 32.4 lbs
- **Carton Size(cm):** 593x445x314(23.4"x17.5"x12.4")
- **Product Applications:** High end Firewall , VPN ,IDS ,Traffic Management, Telecom

Dimension

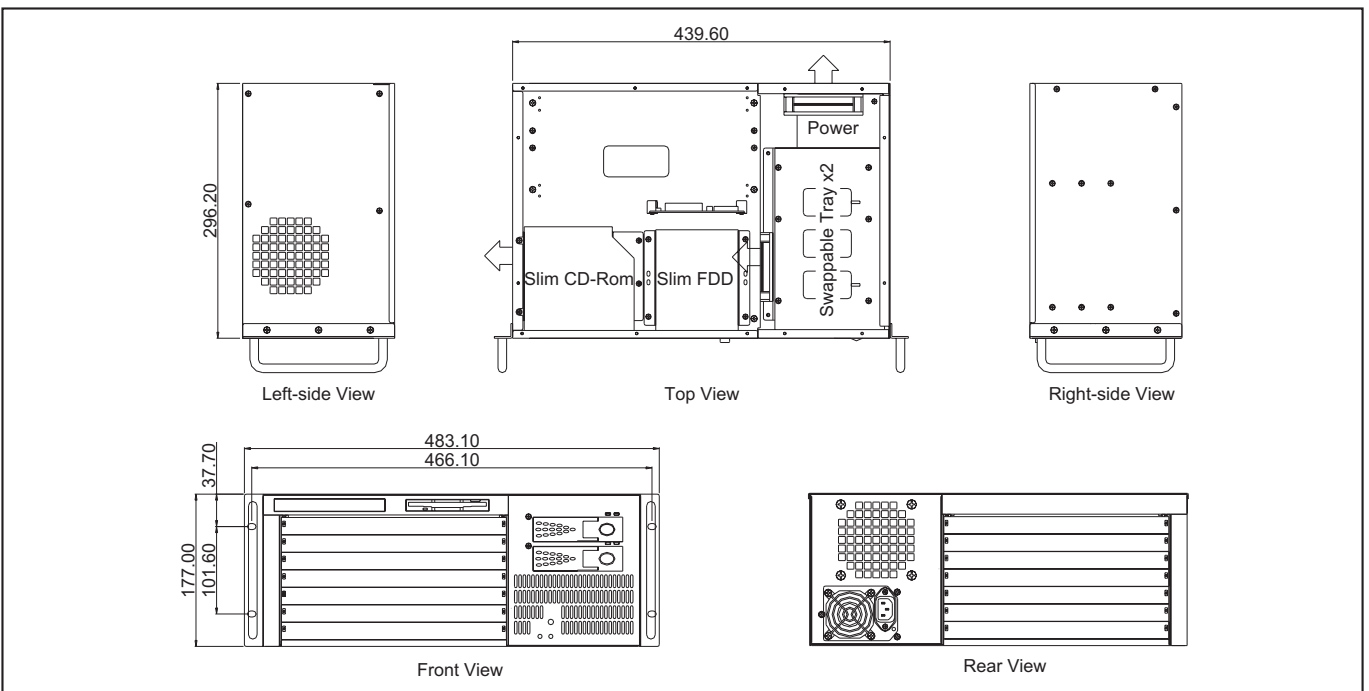

GHC-P03

8U Compact PCI



Specifications

- **EIA RS-310C 19" Rack-mount Standard**
- **Construction:** Rittal System & Heavy Duty Cold Rolled Electroplated Steel
- **Color:** Black (Standard), Beige or Custom
- **Support:** 9-slot High Density Server 6U cPCI Backplane
- **Drive Capacity:** 3x5.25" & 1x3.5"
- **Power Supply(Optional):** PS/2 Size Single 300~460W or Redundant 300~430W P/S
- **Cooling:** 2x(12cm) Blower(32.5CFM ea.) & 2x(9cm) (51CFM ea.) & 1x(12cm) (90CFM) Fans with Removable Air Filter
- **Thermal Management Card:** GHA-CO02
- **Indicators:** LEDs for Power ON/OFF
- **Switch:** Power ON/OFF, System Reset, Buzzer Reset
- **Dimensions (WxHxD):** 483x355x365mm(19"x14.0"x14.4")
- **Cuft:** 6.6
- **GW:** 21.0kgs / 46.3lbs
- **Carton Size(cm):** 63.5x50.2x58.5(25.0"x19.8"x23.0")

Dimension

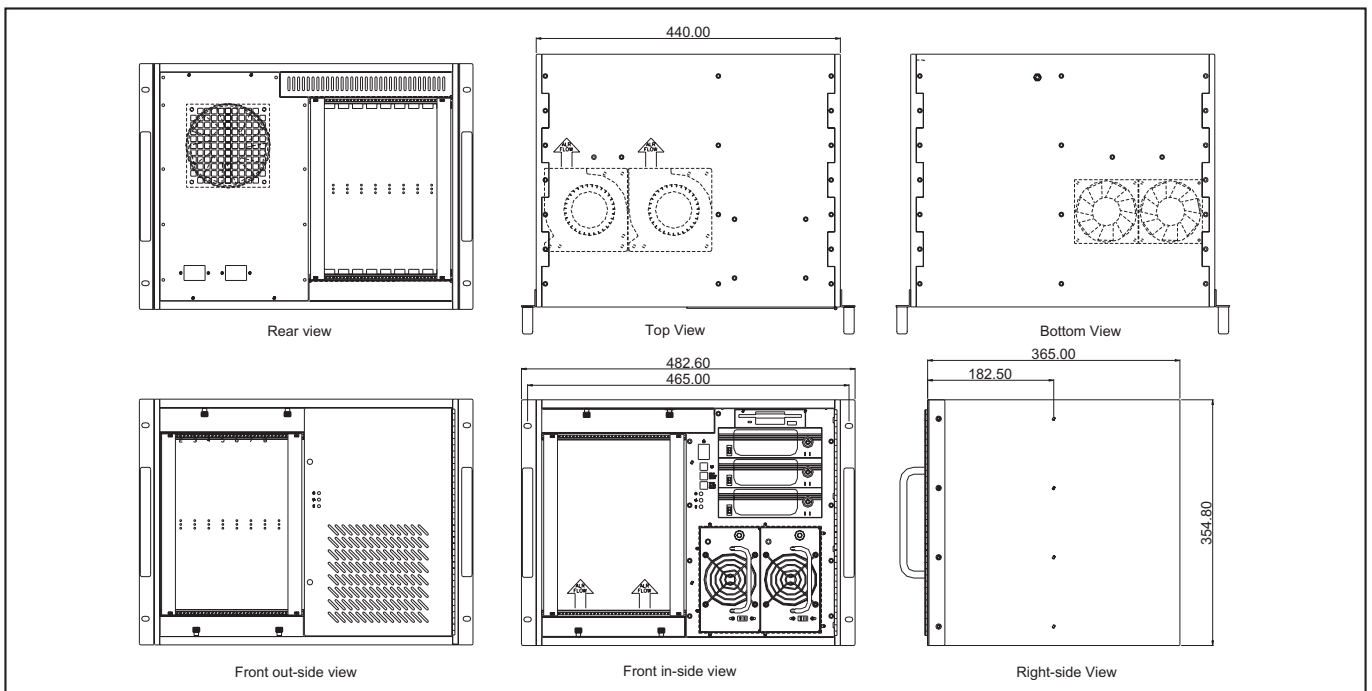

OEM PROJECTS

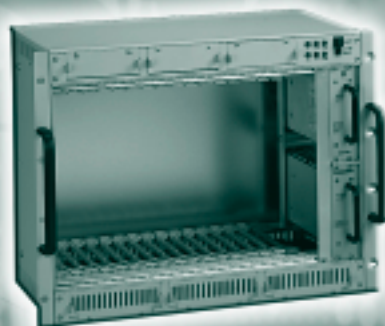

Compact PCI



GHR-219

2U Rackmount Storage Chassis



Specifications

- **EIA RS-310C 19" Rackmount Standard**
- **Construction:** Heavy Duty Cold Rolled Electroplated Steel
- **Color:** Black (Standard), Beige or Custom
- **Drive Interface:** SCSI 320
- **Drive Capacity:** 9xHot Swappable SCSI Trays
- **Power Supply(Optional):** PS/2 Size Single 250~400W P/S or Redundant 300~400W P/S
- **Cooling:** 4x(8cm) Fans(42.5CFM ea.)
- **Thermal Management Card:** GHA-CO02
- **Indicators:** LEDs for Power ON/OFF, HDD Activity, Fan, Temperature
- **Switch:** Power ON/OFF, System Reset
- **Dimensions(WxHxD):** 483x88x450mm(19"x3.5"x17.7")
- **Cuft:** 3.2
- **GW:** 14kgs / 30.9lbs
- **Carton Size(cm):** 63.0x24.8x57.4(24.8"x9.8"x22.6")

Dimension

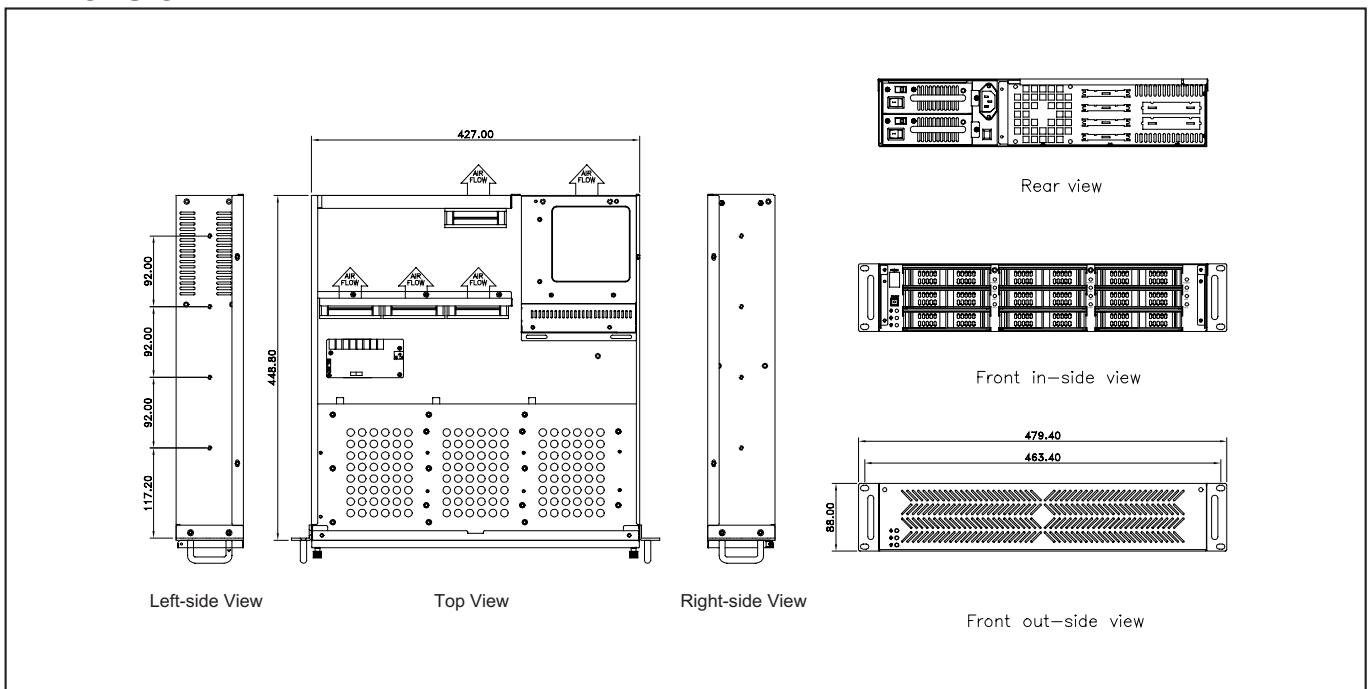

GHR-390

3U Rackmount Storage Chassis



Specifications

- **EIA RS-310C 19" Rackmount Standard**
- **Construction:** Heavy Duty Cold Rolled Electroplated Steel
- **Color:** Black (Standard), Beige or Custom
- **Drive Capacity:** 16x 3.5" Swappable Trays
- **Drive Interface:** SATA, SCSI320 or SAS
- **Power Supply (Optional):** PS/2 Single up to 700W or Mini Redundant up to 500W P/S (Rear Installation) Max. Depth 220mm
- **Cooling:** 4x (92mm = 51CFM ea.) Fans
- **Connector Port (Front):** 2x USB Ports
- **Indicators:** LEDs for Power ON/OFF, HDD Activity, Fan, Temperature, LAN
- **Switch:** Power ON/OFF , System Reset
- **Dimensions (W x H x D):** 483 x 133 x 507mm (19" x 5.2" x 20")
- **Cuft:** 4.2
- **GW:** 18.5 kgs / 40.8 lbs
- **Carton Size(cm):** 58.8 x 28.5 x 70.3 (23.1" x 11.2" x 27.7")
- **Humidity:** 5% - 95% Non-condensing

Dimension

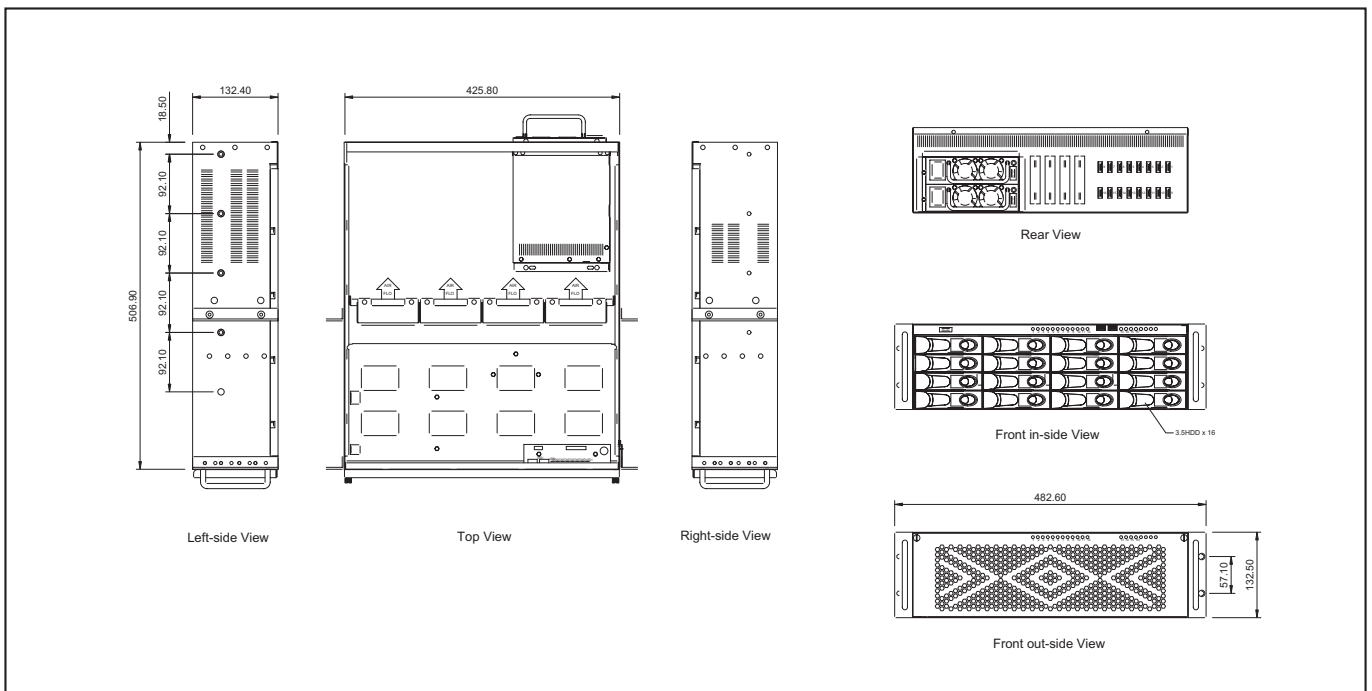

GHR-420

4U Rackmount Storage Chassis



Specifications

- **EIA RS-310C 19" Rackmount Standard**
- **Construction:** Heavy Duty Cold Rolled Electroplated Steel
- **Color:** Black (Standard), Beige or Custom
- **Drive Capacity:** 6x5.25" & 2x3.5"
- **Power Supply(Optional):** PS/2 Size Single 250~400W P/S or Redundant 300~400W P/S
- **Cooling:** 4x(9cm) Fans(51CFM ea.)
- **Front Door:** Single Door With Keylock
- **Air Filter:** Inside Front Door (Washable)
- **Indicators:** LEDs for Power ON/OFF, HDD Activity
- **Switch:** Power ON/OFF, System Reset
- **Dimensions(WxHxD):** 483x177x510mm(19"x7.0"x20.1")
- **Cuft:** 4.9
- **GW:** 18kgs / 39.7lbs
- **Carton Size(cm):** 59.1x34x68.8(23.3"x13.4"x27.1")

Dimension

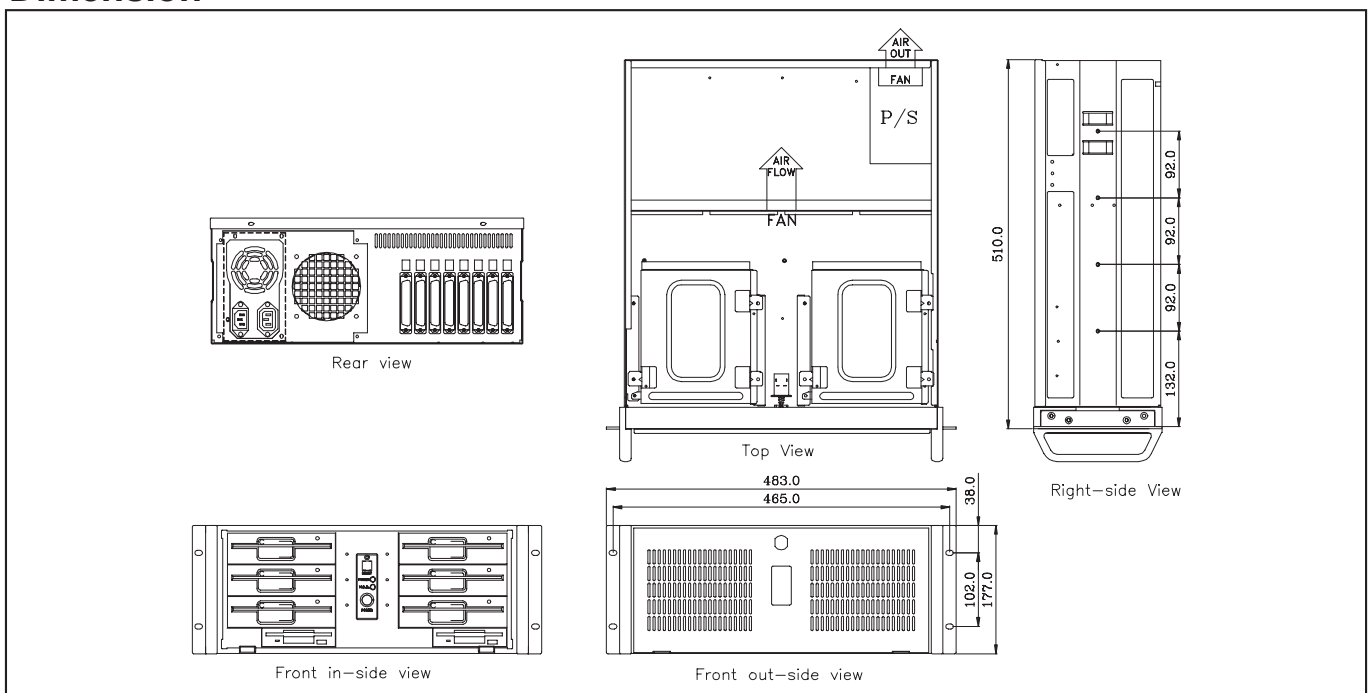

GHR-421

4U Rackmount Storage Chassis



Specifications

- **EIA RS-310C 19" Rackmount Standard**
- **Construction:** Heavy Duty Cold Rolled Electroplated Steel
- **Color:** Black (Standard), Beige or Custom
- **Drive Capacity:** 8x5.25"(Vertical)
- **Power Supply(Optional):** PS/2 Size Single 250~400W P/S or Redundant 300~400W P/S
- **Cooling:** 4x(9cm) Fans(51CFM ea.)
- **Front Door:** Single Door With Keylock
- **Air Filter:** Inside Front Door (Washable)
- **Indicators:** LEDs for Power ON/OFF, HDD Activity
- **Switch:** Power ON/OFF, System Reset
- **Dimensions(WxHxD):** 483x177x510mm(19"x7.0"x20.1")
- **Cuft:** 4.9
- **GW:** 18kgs / 39.7lbs
- **Carton Size(cm):** 59.1x34x68.8(23.3"x13.4"x27.1")

Dimension

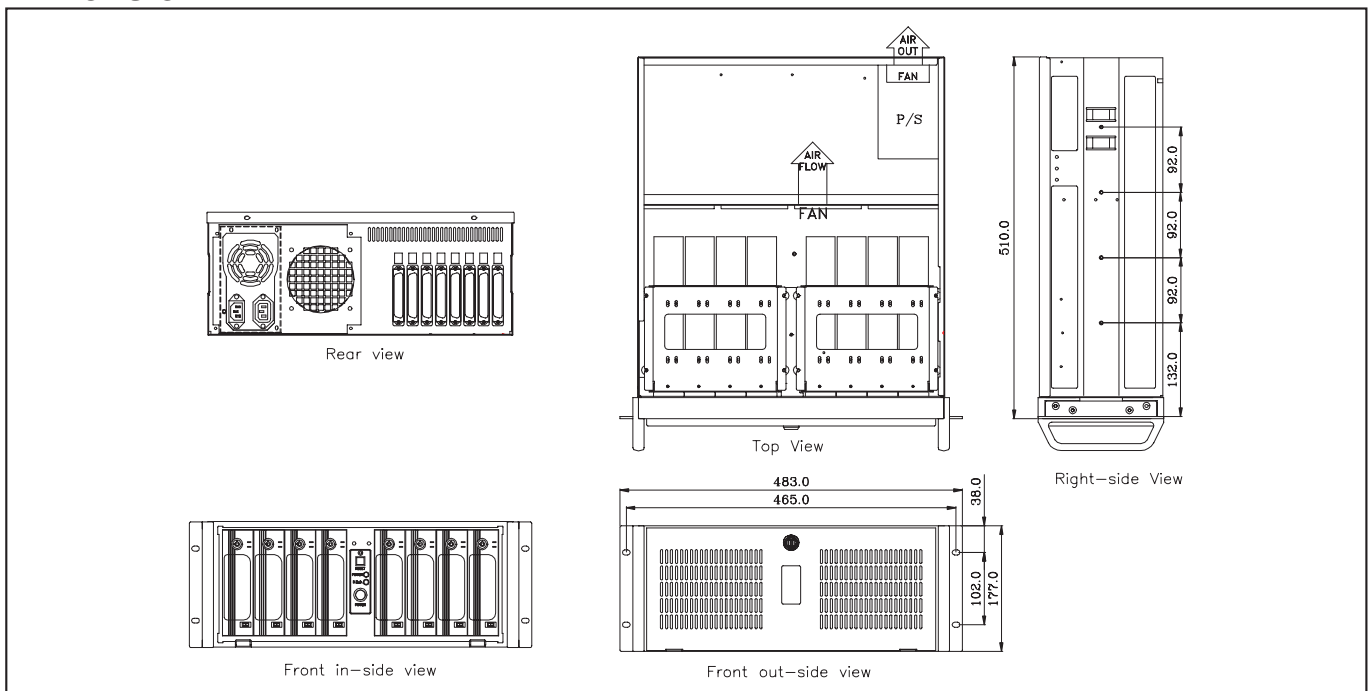

GHR-422

4U Rackmount Storage Chassis



Specifications

- **EIA RS-310C 19" Rackmount Standard**
- **Construction:** Heavy Duty Cold Rolled Electroplated Steel
- **Color:** Black (Standard), Beige or Custom
- **Drive Capacity:** 9x5.25"(Vertical)
- **Power Supply(Optional):** PS/2 Size Single 230~460W P/S or Redundant 300~400W P/S
- **Cooling:** 2x(9cm) Fans(51CFM ea.) & 1x(9cm) Fan(51CFM ea.)(Optional)
- **Thermal Management Card:** CHA-CO04
- **Indicators:** LEDs for Power ON/OFF, HDD Activity, Fan, Temperature
- **Switch:** Power ON/OFF, System Reset, Buzzer Reset
- **Dimensions(WxHxD):** 483x177x510mm(19"x7.0"x20.1")
- **Cuft:** 4.9
- **GW:** 24.3kgs / 53.6lbs
- **Carton Size(cm):** 59.1x34x68.8(23.3"x13.4"x27.1")

Dimension

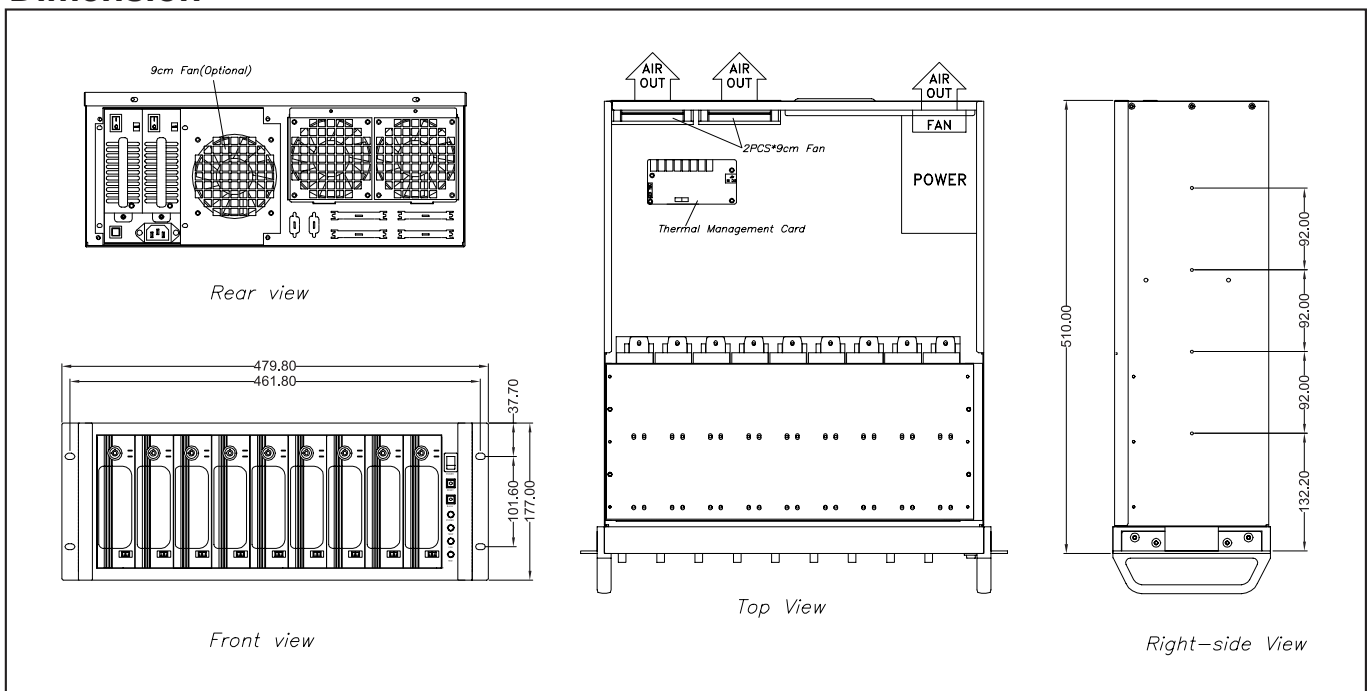

GHR-2104

Disk Array Chassis



Specifications

- **Construction:** Heavy Duty Cold Rolled Electroplated Steel
- **Color:** Beige (Standard), Black or Custom
- **Drive Capacity:** 12x5.25"
- **Power Supply(Optional):** Redundant 300~400W P/S
- **Cooling:** 2x(9cm) Fans(51CFM ea.)
- **Indicators:** LEDs for Power, HDD Activity
- **Switch:** Power ON/OFF, System Reset
- **Four Adjustable Circular Pedestals**
- **Dimensions(WxHxD):** 200x608x435mm(7.9"x24.0"x17.1")
- **Cuft:** 4.5
- **GW:** 17.5kgs / 38.6lbs
- **Carton Size(cm):** 32.5x70.5x55.4(12.8"x27.8"x21.8")

Dimension

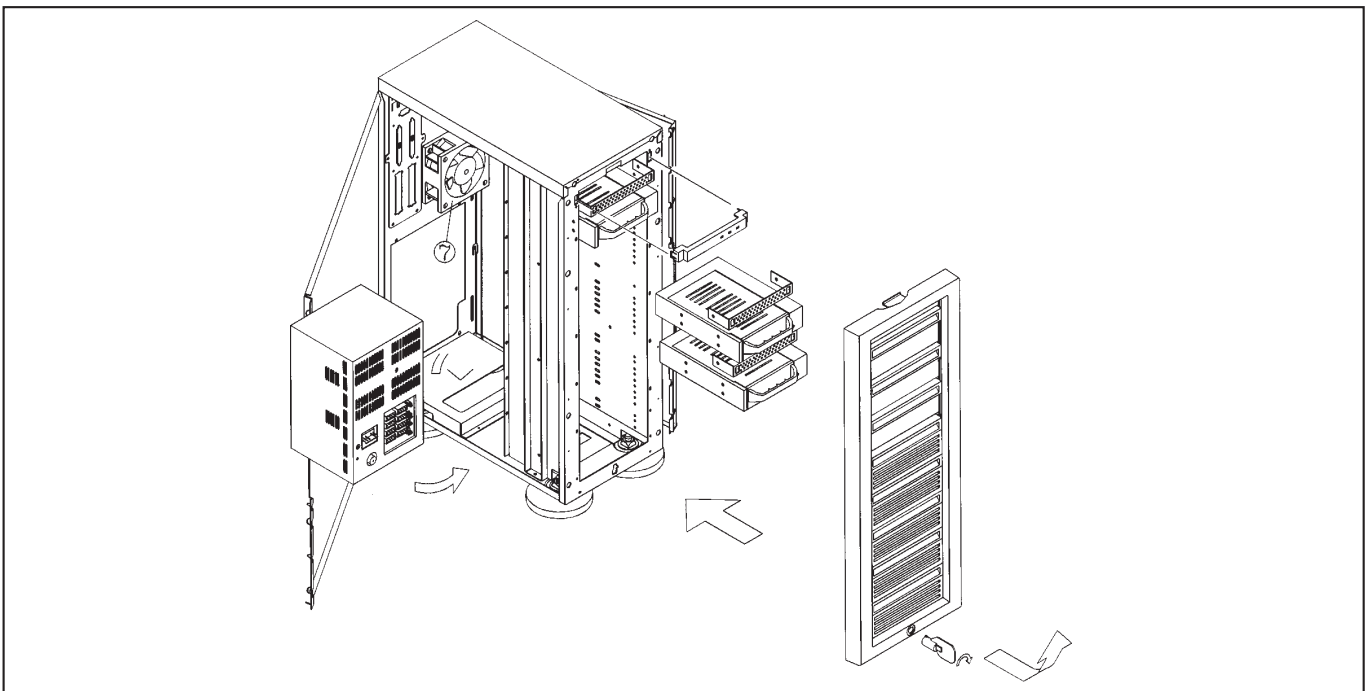

GHS-1500

Server Case



Specifications

- **Server / RAID case or 19" Rack Mounted**
- **Construction:** Heavy Duty Cold Rolled Electroplated Steel
- **Color:** Black or Custom Design
- **Support ATX M/B(Max. to 12"x13")**
- **Support 14-slot Passive Backplane**
- **Drive Capacity: 15x5.25"**
- **Power Supply(Optional):** PS/2 Size Single 250~400W P/S or Redundant 300~400W P/S or Triple Redundant 800+400W P/S
- **Cooling:** 5x(9cm) Fans(51CFM ea.)
- **Indicators:** LEDs for Power ON/OFF, HDD Activity, Fan, Temperature
- **Switch:** Power ON/OFF, System Reset, Buzzer Reset
- **Lockable Security Access and Lockable Casters**
- **Dimensions(WxHxD):** 410x416x710mm(16.2"x16.4"x28.0")
- **Cuft:** 9.3
- **GW:** 34kgs / 75lbs
- **Carton Size(cm):** 54.8x55.8x85.7(21.6"x22.0"x33.7")



GHA-1520

- **GHS-1500,GHS-2000 Rackmount Tray (Optional)**

GHS-2000

Server Case



Specifications

- **Server / RAID case or 19" Rack Mounted**
- **Construction:** Heavy Duty Cold Rolled Electroplated Steel
- **Color:** Black or Custom Design
- **Support ATX M/B(Max. to 16"x13")**
- **Support 20-slot Passive Backplane**
- **Drive Capacity:** 23x5.25"
- **Power Supply(Optional):** PS/2 Size Single 250~400W P/S or Redundant 300~600W P/S or Triple Redundant 800+400W P/S
- **Cooling:** 8x(9cm) Fans(51CFM ea.) & 2x(12cm) Fans(108CFM ea.)
- **Indicators:** LEDs for Power ON/OFF, HDD Activity, Fan, Temperature
- **Switch:** Power ON/OFF, System Reset, Buzzer Reset
- **Thermal Management Card Installed**
- **Lockable Security Access and Lockable Casters**
- **Dimensions(WxHxD):** 410x600x710mm(16.2"x23.6"x28.0")
- **Cuft:** 12.2
- **GW:** 44kgs / 97lbs
- **Carton Size(cm):** 54.8x73.6x85.7(21.6"x29.0"x33.7")



GHA-1520

- **GHS-1500,GHS-2000 Rackmount Tray (Optional)**

SG-1200

Server Case



Specifications

- **Pedestal Server Chassis**
- **Construction:** Heavy Duty Cold Rolled Electroplated Steel
- **Color:** Beige (Standard), Black or Custom
- **Support:** 10 Slot Passive Backplane
- **Drive Capacity:** 12 x 5.25" CD-ROM
- **Power Supply (Optional):** PS2 up to 700W or Mini Redundant 500W AT or ATX P/S (Rear Installation) Max. Depth 220mm
- **Cooling:** 2x (92mm) Fans
- **Extra Features:** 4 x Height Adjustable Circular Pedestals
- **Thermal Management Card:** GHA-CO04
- **Indicators:** LEDs for Power ON/OFF & HDD Activity
- **Switch:** Power ON/OFF Momentary (Rocker), System Reset, Buzzer Reset
- **Dimensions (W x H x D):** 210 x 608 x 650mm (8.3" x 24" x 25.6")
- **Cuft:** 8
- **GW:** 21.5kgs / 47.4lbs
- **Carton Size(cm):** 85.5 x 34.0 x 59.1(33.7" x 13.4" x 23.3")
- **Humidity:** 5% - 95% Non-condensing

SG-4002XC

Server Case



Specifications

- **Construction:** Heavy Duty Cold Rolled Electroplated Steel
- **Color:** Beige (Standard) or Custom Design
- **Support EATX M/B(Max. to 12"x13")**
- **Support 14-slot Passive Backplane**
- **Drive Capacity:** 16x5.25"
- **Power Supply(Optional):** PS/2 Size Single 300~400W P/S or Redundant 300~400W P/S
- **Cooling:** 4x(9cm) Fans(51CFM ea.) & 4x(9cm) Fans (51CFM ea.)(Optional)
- **Indicators:** LEDs for Power ON/OFF & HDD Activity
- **Switch:** Power ON/OFF, Sleep, System Reset
- **Convenient SCSI ID Switches for Individual Drive(Optional)**
- **Multiple Sub-System Combination**
- **Link Panel:** SCSI 50/68 Pin Connector
- **Detachable Swing-Option Side Doors**
- **Lockable Security Access and Lockable Casters**
- **Dimensions(W x H x D):** 424 x 605 x 435mm (16.7" x 23.8" x 17.1")
- **Cuft:** 8.0
- **GW:** 26.5kgs / 58.3lbs
- **Carton Size(cm):** 52.4x76.1x57.0(20.6"x30.0"x22.4")



GHK-425

Hot-Swappable Disk Array



Specifications

- **Mounted into a 5.25" Drive Space**
- **Construction:** Heavy Duty Cold Rolled Electroplated Steel
- **Color:** Black (Standard), Beige or Custom
- **Drive Capacity:** 4x 2.5" Hot Swappable Drive Trays
- **Drive Interface:** SATA, SCSI320 or SAS
- **Powered by 4pin Connector from the P/S**
- **Cooling:** 1x (40mm) Internal Fan
- **Thermal Management Function Installed**
- **Indicators:** LEDs for Power ON/OFF, Individual HDD Activity, Temperature
- **Switch:** Buzzer Reset
- **Dimensions (W x H x D):** 146 x 40.8 x 198mm (5.8" x 1.6" x 7.8")
- **Cuft:** 0.3
- **GW:** 0.9 kgs / 2.0 lbs
- **Carton Size(cm):** 22 x 12.5 x 27 (8.7" x 4.9" x 10.6")
- **Humidity:** 5% - 95% Non-condensing

GHK-431

Hot-Swappable Disk Array



Specifications

- **Mounted into a 3x 5.2" Drive Space**
- **Construction:** Heavy Duty Cold Rolled Electroplated Steel
- **Color:** Black (Standard), Beige or Custom
- **Drive Capacity:** 4x 3.5" Hot Swappable Drive Trays
- **Drive Interface:** SATA, SCSI320 or SAS
- **Powered by 4pin Connector from the P/S**
- **Cooling:** 2x (60mm) Internal Blower Fans
- **Indicators:** LEDs for Power ON/OFF, Individual HDD Activity
- **Dimensions (W x H x D):** 146 x 128 x 187mm (5.8" x 5.0" x 7.4")
- **Cuft:** 0.7
- **GW:** 5.5kgs / 12.1lbs
- **Carton Size(cm):** 26 x 24 x 31 (10.3" x 9.5" x 12.2")
- **Humidity:** 5% - 95% Non-condensing

GHK-541

Hot-Swappable Disk Array



Specifications

- **Mounted into a 4x 5.25" Drive Space**
- **Construction:** Heavy Duty Cold Rolled Electroplated Steel
- **Color:** Black (Standard), Beige or Custom
- **Drive Capacity:** 5x 3.5" Hot Swappable Drive Trays
- **Drive Interface:** SATA, SCSI320 or SAS
- **Powered by 4pin Connector from the P/S**
- **Cooling:** 2x (60mm) Internal Blower Fans
- **Indicators:** LEDs for Power ON/OFF, Individual HDD Activity
- **Dimensions (W x H x D):** 146 x 171.5 x 187mm (5.8" x 6.8" x 7.4")
- **Cuft:** 0.8
- **GW:** 6kgs / 13.2lbs
- **Carton Size(cm):** 26 x 28 x 31 (10.3" x 11" x 12.2")
- **Humidity:** 5% - 95% Non-condensing

Accessories



GHA-CO01

- Two Sets of Temperature Sensor
- Three Level Temperature Setting(40°C, 50°C, 60°C)
- Front Panel LEDs System Status Display
- External Alarm Connector And Internal Buzzer
- 2-Pin Fan Failure Detect and Control

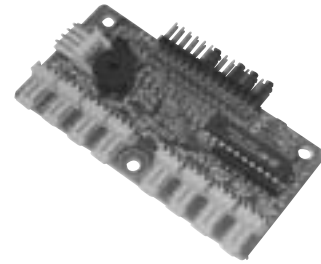

GHA-CO04

- Two Sets of Temperature Sensor
- Three Level Temperature Setting(40°C, 50°C, 60°C)
- Front Panel LEDs System Status Display
- Internal Buzzer
- 3-Pin Fan Failure Detect and Control



GHA-CO02

- Two Sets of Temperature Sensor
- Three Level Temperature Setting(40°C, 50°C, 60°C)
- Front Panel LEDs System Status Display
- Internal Buzzer
- 3-Pin Fan Failure Detect and Control



GHA-CO05

- Four Set of Temperature and Fan Dip Switch Setting and Connectors for Temperature Control
- LEDs System Status Display(Normal-Green,Abnormal-Red)
- 2 - Pin Fan Connectors for Fan Detect and Status Display
- 3 - Pin Temperature Connectors for Temperature Detect
- Three Connectors (CN) for DC Input, Power and HDD LED Input Respectively
- Four Temperature Limit Adjust Connectors/Settings

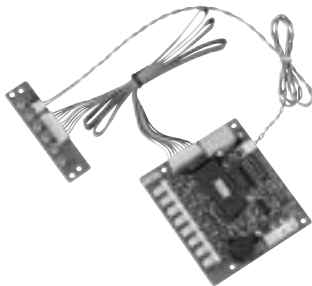

GHA-CO03

- Two Sets of Temperature Sensor
- Three Level Temperature Setting(40°C, 50°C, 60°C)
- Front Panel LEDs System Status Display
- Internal Buzzer
- 3-Pin Fan Failure Detect and Control



GHA-BRM1

- B04, B08 Rackmount Application

Accessories



GHA-SL20-1U/ SL24-1U

- Zinc Plated
- Mounting by Screw Application in General Frame
- Heavy Duty Metal Slide Rail
- GHA-SL20-1U: 20" Slide Rail for 19" 1U Chassis
- GHA-SL24-1U: 24" Slide Rail for 19" 1U Chassis



GHA-SL20/ SL24/ SL26

- Zinc Plated
- Mounting by Screw Application in General Frame
- Heavy Duty Metal Slide Rail
- GHA-SL20: 20" Slide Rail for 19" Chassis
- GHA-SL24: 24" Slide Rail for 19" Chassis
- GHA-SL26: 26" Slide Rail for 19" Chassis



RL-CC1001-99-0104/CC3001-00-0240/CC3001-00-0260

- Mounting by Screw Application in General Frame
- Heavy Duty Metal Slide Rail
- RL-CC1001-99-0104: 30" Full Extension Slide Rail for 19" Chassis(Supports up to 175 lbs)
- RL-CC3001-00-0240: 24" Slide Rail for 19" Chassis
- RL-CC3001-00-0260: 26" Slide Rail for 19" Chassis



GHA-H199

- "L" shape Bracket for 3.5" Drive



GHA-H211

- Holder Bracket for 3x3.5" Drives

Accessories

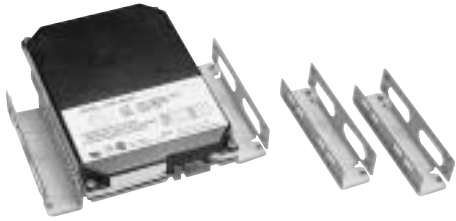

GHA-H300

- Holder Bracket for 3.5" Drive



GHA-H414

- Holder Bracket for 3.5" Drive

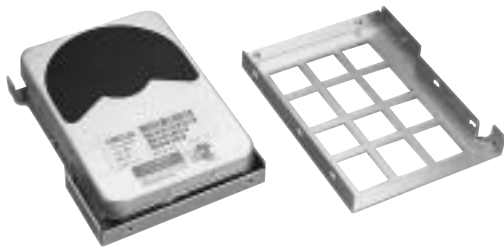

GHA-H431

- "L" Shape Bracket for 3.5" Drive

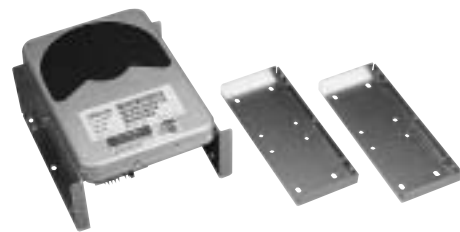

GHA-H432

- "L" Shape Bracket for 2x3.5" Drive



GHA-H280

- Holder Bracket for GHI-280/281/282/283 Extra Drive



GHA-H380

- Holder Bracket for GHI-380/381 Extra 1 or 2x3.5" Drives

Accessories



GHA-H480

- Holder Bracket for GHI-480/481 Extra 2x3.5" Drives



GHA-1520

- GHS-1500, GHS-2000 Rackmount Tray



GHA-4HL

- Handle with "L" shape Bracket for 4U Rackmount Chassis



GHA-4UL

- "L" Shape Bracket for 4U Rackmount Chassis



GHA-4UH

- Chromium-Plated Handle for 4U Chassis

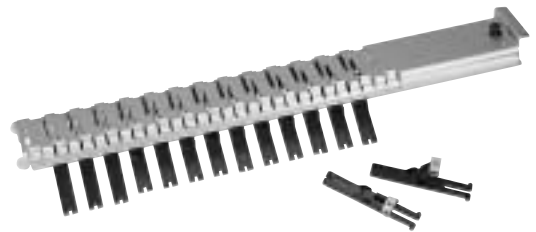

GHA-TE01

- Adjustable Trigger Type Hold Down Bar

Accessories

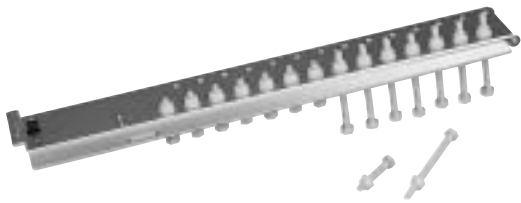

GHA-YT01

- Adjustable Screw Type Hold Down Bar



GHA-410

- Adjustable 2 Section Type Hold Down Bar



GHA-418

- Adjustable Flipper Type Hold Down Bar

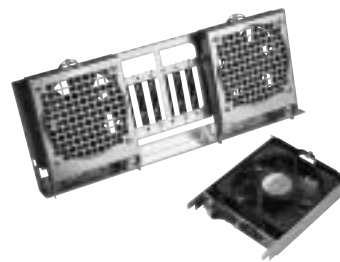

GHA-F123

- Hot-Swappable Ball Bearing Fan Set
- 3x(12cm) DC Fans, 90CFM ea.
- 5U Chassis Application



GHA-F418

- Extra Cooler for GH-418 Model
- 3 Sets of 12V DC Blower, 32CFM ea.
- Dimension: 108x306x28mm



GHA-F520

- Extra Cooler for GH-5U Chassis
- 3 Sets of 12V DC Blower, 32CFM ea.
- Dimension: 108x372x28

Accessories

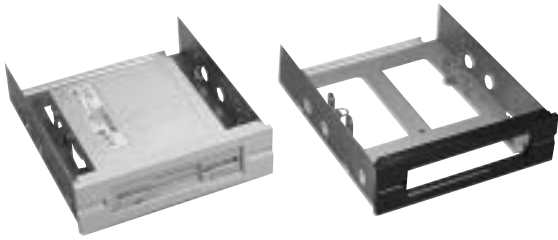

GHA-FM01

- Drive Adapters
To mount a 3.5" drive into one 5.25" drive bay



GHA-FM03/FH03

- Drive Loading Enclosure
- Concise in 5.25" Drive Bay
- FM03:1xSlim CD-ROM & 1x3.5" FDD Drive Bay
- FH03:1xSlim CD-ROM & 1xSlim FDD & 1x2.5" Drive Bay



GHA-FM04/FH04

- Drive Loading Enclosure
- Concise in 5.25" Drive Bay
- FM04:1xSlim CD-ROM & 1xSlim FDD & 1x2.5" Drive Bay
- FH04:1xSlim CD-ROM & 1x3.5" HDD Drive Bay



GHA-FM05/FH05

- Drive Loading Enclosure
- Concise in 5.25" Drive Bay
- FM05:1xSlim CD-ROM & 1xSlim FDD Drive Bay
- FH05:1xSlim CD-ROM & 1x2.5" HDD Drive Bay



GHA-FM06

- Drive Loading Enclosure
- Concise in 5.25" Drive Bay
- 3.5" Drive Space with IDE/SATA/SCSI320/SAS Backplane (Optional)



GHA-FM07

- Drive Loading Enclosure
- Concise in 5.25" Drive Bay
- 2xSlim CD-ROM Drive Bay

Accessories



GHA-FM801

- Drive Loading Enclosure
- Concise in 3.5" Drive Bay
- Support one 3.5" Drive

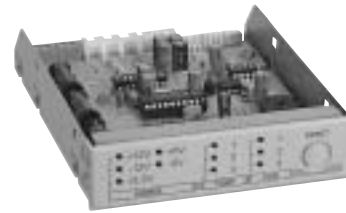

GHA-ED01X

- Power & Voltage Detect
- Fan Performance Audit
- Thermal Management Control
- Remote Warning Applicable
- Concise in 3.5" Drive Bay
- AT/ATX Interchangeable



SDR-083

- Slim DVD-ROM With IDE Adaptor
- Support any OS system including Linux, Win2000, WinXP, Solaris.
- DVD 8X/ CD 24X, 12.7mm Drawer, DVD-Multi R, SMART-X, DFS mechanism.
- Master/ Slave adjustable (default is master).
- Only Black color available.



SDW-082S

- Slim DVD Rewritable Drive With IDE Adaptor
- Support any OS systems including Linux, Win2000, WinXP, Solaris.
- 8X DVD+R, 4X DVD-R, 4X DVD+RW, 4X DVD-RW, 24X CD-R, 10X CD-RW.
- 8X DVD/ 24X CDR as reading speed.
- Master/ Slave adjustable (default is master).
- Only Black color available.



GHA-SR242

- Brand: Mitsumi
- Model: SR242(24xslim CD-ROM)



GHA-D353

- Brand: Mitsumi
- Model: D353F3 (Slim FDD, 1.44MB, 3 Mode)

Accessories



GHA-K002

- Adapter For Slim CD-ROM & Slim FDD

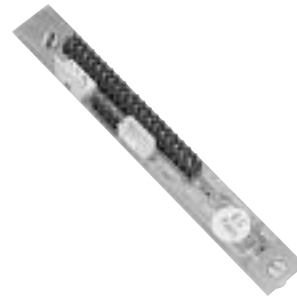

GHA-K003

- Adapter For Slim CD-ROM



GHA-K004

- Adapter For Slim FDD

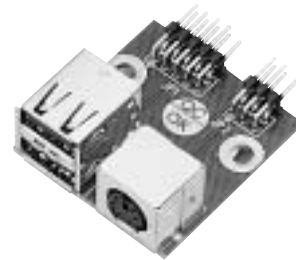

GHA-K005

- Adapter For USB & PS2



GHA-K006

- Adapter For 2 USB



GHA-181WV2/280WV2

- Special Design for High Performance Intel Server Board Model No:7500WV2
- for 1U Chassis(GHA-181WV2)
- for 2U Chassis(GHA-280WV2)

Accessories

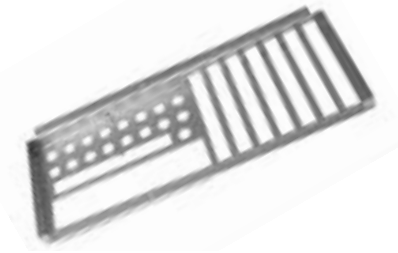

GHA-DVR-17H

- For 4U up to 8U Chassis
- Support 17 BNC Connectors



GHA-BW205

- for 2U Chassis
- Support 2 Horizontal Expansion Slots for fitting on the 5th M/B Slot



GHA-BW206

- for 2U Chassis
- Support 2 Horizontal Expansion Slots for fitting on the 6th M/B Slot



GHA-BW256

- for 2U Chassis
- Support 2 Horizontal Expansion Slots for fitting on the 5th & 6th M/B Slot



GHA-BW305

- for 2U Chassis
- Support 3 Horizontal Expansion Slots for fitting on the 5th M/B Slot



GHA-BW306

- for 2U Chassis
- Support 3 Horizontal Expansion Slots for fitting on the 6th M/B Slot

Accessories



GHA-690-A

- Extra Bracket for GHI-690/691 Chassis
- Cooling: 4 x (40 x 28mm = 15.3CFM ea.) Fans



GHA-690-B

- Extra Bracket for GHI-690/691 Chassis
- Drive Capacity: 2x 5.25" CD-ROM



GHA-690-C

- Extra Bracket for GHI-690/691 Chassis
- Drive Capacity: 1x 5.25" CD-ROM & 2x 3.5"HDD
- Cooling: 2x (92mm = 30.5 CFM ea.) Blowers



GHA-690-D

- Extra Bracket for GHI-690/691 Chassis
- Drive Capacity: 4x 3.5" Swappable Trays
- Drive Interface: SATA, SCSI 320 or SAS

Passive Backplane & Riser Card

Model	Riser Card				Goden Finger Interface	Chassis	
	ISA.	AGP	AGP PRO	PCI			
GHP-100				1	(32bit)	GH-188ATX	
GHP-R0101				1	(32bit)	GHI-104/105/106/110/112/113/114/130/180/181	
GHP-R0102				1	(64bit 5.0V)	GHI-104/105/106/110/112/113/114/130/180/181	
GHP-R0103				1	(64bit 3.3V)	GHI-104/105/106/110/112/113/114/130/180/181	
GHP-R0110(GHP-141)				1	(32bit)	GHI-142	
GHP-R0119				1	(64bit 3.3V)	GHI-181WV2	
GHP-R0104				1	(64bit 3.3V)	GH-212ATX/231ATX/232ATX/241ATX/242ATXR/ 244ATXR/245ATX/GHI-210/213/230/252H/280/280WV2/ 281/281WV2/282/283/283WV2	
GHP-200	1			2	(16&32bit)		
GHP-205				1	(32bit)		
GHP-206				1	(32bit)		
GHP-R0301				3	(32bit)		
GHP-R0302				3	(64bit 5.0V)		
GHP-R0303				3	(64bit 3.3V)		
GHP-R0304				3	(64bit 3.3V)		
GHP-R0305				3	(64bit 5.0V)		
GHP-R0308				3	(32bit)		
GHP-R0309				1	(64bit 3.3V)		
GHP-AGP01		1		2	(32bit)		
GHP-AGP02		1		2	(32bit)		
GHP-AGP03			1	2	(32bit)		
GHP-AGP04			1	2	(64bit 3.3V)		
GHP-AGP05			1	2	(64bit 5.0V)		
GHP-AGP06			1	2	(64bit 3.3V)		
GHP-AGP07			1	2	(64bit 5.0V)		
GHP-PCI106H				1	(32bit 5.0V)		GHB-B05 , 1U Chassis
GHP-08X16					1 PCI Express x 16		1U Chassis
GHP-09X16					1 PCI Express x 16	1U Chassis	
GHP-U642-C7				1 (32bit)	2 PCI-X (64bit)	2U Chassis	
GHP-U656-C5					3 PCI-X (64bit)	2U Chassis	
GHP-U740				2 (32bit)	1 PCI Express x 16	2U Chassis	
GHP-U746-C9					2 PCI-X & 1 PCI Express x 16	2U Chassis	
GHP-U790				2	1 PCI Express x 16	2U Chassis	

Passive Backplane & Riser Card

Model	Slot of Backplane			Power Connector			Chassis
	Sys.	AGP	AGP PRO	PCI	AT	ATX	
GHP-B2SD	1		1	1	X		GH-199B
GHP-G1UG1	1	1	1	1		X	GHI-100
GHP-AD3S2	1		1	2		X	GHI-100
GHP-B5SD	1	2	1	2	X		GH-288SR
GHP-B4PS1	1		1	4	X		GH-288SR
GHP-AD6S4	1	1	1	4	X	X	GHI-200/GH-288SR
GHP-B6SD	1	3	1	2	X		GH-288SR
GHP-P2UP4	1		2	4	X	X	GHI-200/GH-288SR
GHP-2004	1	4			X	X	GHB-B04
GHP-2204	1		2	3	X	X	GHB-B04
GHP-2006	1	6			X	X	GHB-060
GHP-2206	1	1	2	4	X	X	GHB-060
GHP-2308	1	4	1	3	X		GHB-B08
GHP-2008	1	8			X	X	GH-400S/402SR/403SR/410SR/411SR/414SR
GHP-2208	1	3	2	4	X	X	/416SR/418SR/419SR/431SR/GHB-080
GHP-2014	1	14			X	X	GH-400SR/402SR/403SR/410SR/411SR/414SR/416SR /418SR/419SR/431SR/GHS-1500/SG-4002XC
GHP-2214	1	8	2	4	X	X	
GHP-P14P4	1	8	2	4	X	X	
GHP-2214D	2	2	4	8	X	X	
GHP-2020	1	20			X		GH-430SR/432SR/520SR/620SR/820SR/GHI-611/GHS-2000
GHP-2020S	1/2/3/4	20			X		
GHP-2220	1	13	3	4	X	X	
GHP-2220G	1	6	2	12	X	X	
GHP-2220Q	4		8	12	X	X	
MBP-PCI-10-ATX	1	4	2	4	X	X	GHB-120
MBP-206B	1	4			X		GHB-083
MBP-PCI6R-ATX	1	2	2	3	X	X	GHB-060/062
PCI-08P4	1	2	2	4	X	X	GHB-080/082
10I-ATX	1	10			X	X	GHB-120
PCI-10P7-E1	1	2	2	7	X	X	GHB-120
PCI4-ATX	1			5	X	X	GHB-042
PCI-06P3	1	1	2	3	X	X	GHB-060/062
GHP-N2UP5	1		2 PCIe	2		X	GHI-200/GH-288SR

Riser Card Series



GHP-100

Independent 32 Bit PCI Slot only for GH-188 ATX model



GHP-R0104

Independent 64Bit 3.3V PCI Slot For 2U Rackmount Chassis



GHP-R0101

Independent 32Bit PCI Slot For 1U Rackmount Chassis



GHP-R0110(GHP-141)

Independent 32 Bit PCI Slot For 1U Rackmount Chassis



GHP-R0102

Independent 64Bit 5.0V PCI Slot For 1U Rackmount Chassis



GHP-R0119

Independent 64Bit 3.3V PCI Slot For 1U Rackmount Chassis



GHP-R0103

Independent 64Bit 3.3V PCI Slot For 1U Rackmount Chassis



GHP-200

2 PCI or 1*PCI&1 ISA Expansion Slot For 2U Rackmount Chassis

Riser Card Series



GHP-PCI106H

1 PCI 32Bit 5.0V For GHB-B05 or 1U Rackmount Chassis



GHP-08X16

1 PCI Express For 1U Rackmount Chassis



GHP-19X16

1 PCI Express X16 For 1U Rackmount Chassis

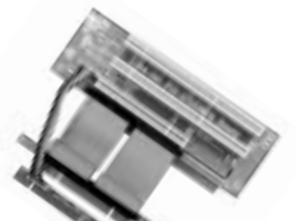

GHP-U642-C7

2 PCI-X 64Bit + 1 PCI 32Bit For 2U Rackmount Chassis



GHP-U656-C5

3 PCI-X 64Bit For 2U Rackmount Chassis



GHP-U740

2 PCI 5.0V 32Bit + 1 PCI Express X16 For 2U Rackmount Chassis

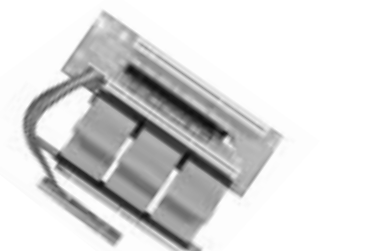

GHP-U746-C9

2 PCI-X 3.3V 64Bit + 1 PCI Express X16 For 2U Rackmount Chassis

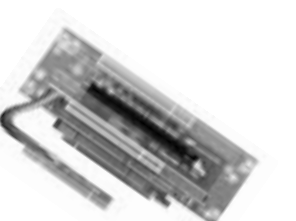

GHP-U790

2 PCI 5.0V 32Bit + 1 PCI Express X16 For 2U Rackmount Chassis

Riser Card Series



GHP-205

Independent 1-32Bit PCI Slot For 2U Rackmount Chassis



GHP-R0303

3-64Bit 3.3V PCI Slot For 2U Rackmount Chassis



GHP-206

Independent 1-32Bit PCI Slot For 2U Rackmount Chassis



GHP-R0304

3-64Bit 3.3V PCI Slot For 2U Rackmount Chassis



GHP-R0301

3-32Bit PCI Slot For 2U Rackmount Chassis



GHP-R0305

3-64Bit 5.0V PCI Slot For 2U Rackmount Chassis



GHP-R0302

3-64Bit 5.0V PCI Slot For 2U Rackmount Chassis



GHP-R0309

Independent 64Bit 5.0V PCI Slot For 1U Rackmount Chassis

Riser Card Series



GHP-R0308

3-32Bit PCI Slot For 2U Rackmount Chassis



GHP-AGP04

2-64Bit 3.3V PCI Slot + 1 AGP PRO Slot For 2U Rackmount Chassis



GHP-AGP01

2-32Bit PCI Slot + 1 AGP Slot For 2U Rackmount Chassis



GHP-AGP05

2-64Bit 5.0V PCI Slot + 1 AGP PRO Slot For 2U Rackmount Chassis



GHP-AGP02

2 -32Bit PCI Slot + 1 AGP Slot For 2U Rackmount Chassis



GHP-AGP06

2 -64Bit 3.3V PCI Slot + 1 AGP PRO Slot For 2U Rackmount Chassis



GHP-AGP03

2-32Bit Slot + 1 AGP PRO Slot For 2U Rackmount Chassis



GHP-AGP07

2 -64Bit 5.0V PCI Slot + 1 AGP PRO Slot For 2U Rackmount Chassis

Passive Backplane



Right side



Left side

GHP-B2SD

1xPCI & 1xPICMG CPU Slot



Right side



Left side

GHP-G1UG1

1xISA & 1xPCI & 1xPICMG CPU Slot



Right side



Left side

GHP-AD3S2

2xPCI & 1xPICMG CPU Slot

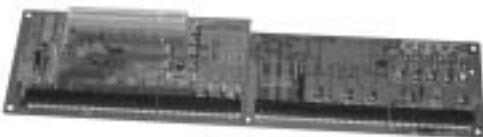

Right side



Left side

GHP-N2UP5

2xPCI & 2xPCI Express & 1xPICMG 1.3CPU Slot

Passive Backplane



Right side



Left side

GHP-B4PS1

4xPCI & 1xPICMG CPU Slot

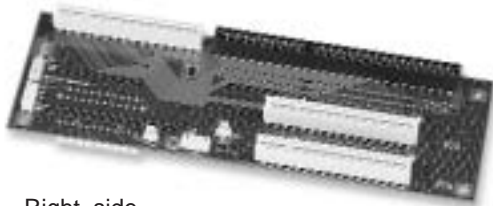

Right side

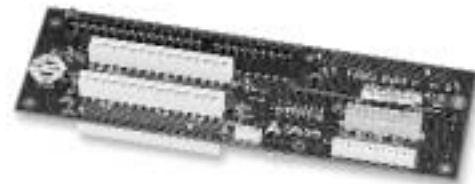

Left side

GHP-AD6S4

1xISA & 4xPCI & 1xPICMG CPU Slot



Right side



Left side

GHP-B6SD

3xISA & 2xPCI & 1xPICMG CPU Slot

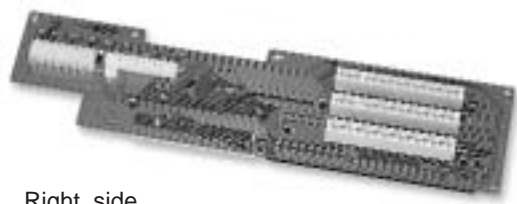

Right side



Left side

GHP-P2UP4

4xPCI & 2xPICMG CPU Slot

Passive Backplane

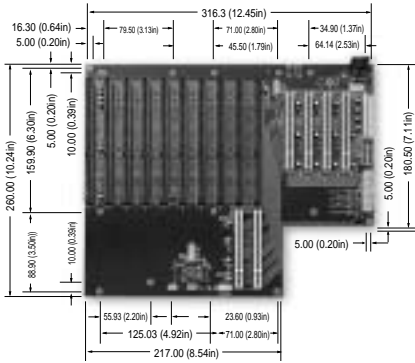

GHP-2214
8xISA & 4xPCI & 2xPICMG CPU Slot(Single System)

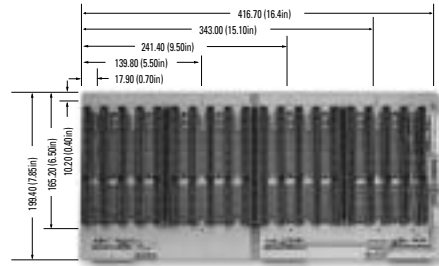

GHP-2020S
20xISA Slot(Quad System)

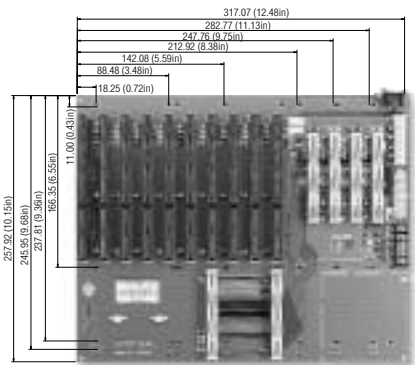

GHP-P14P4
8xISA & 4xPCI & 2xPICMG CPU Slot(Single System)

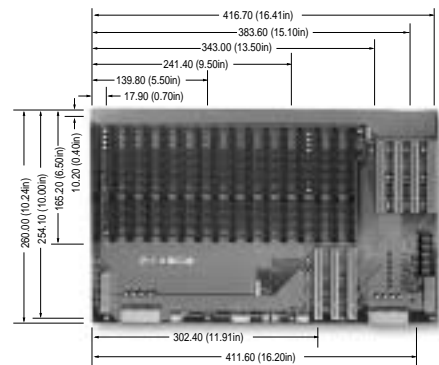

GHP-2220
13xISA & 4xPCI & 3xPICMG CPU Slot(Single System)

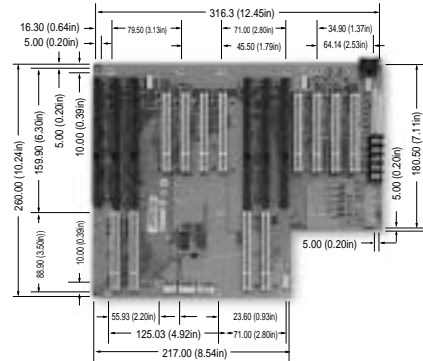

GHP-2214D
2xISA & 8xPCI & 4xPICMG CPU Slot(Dual System)

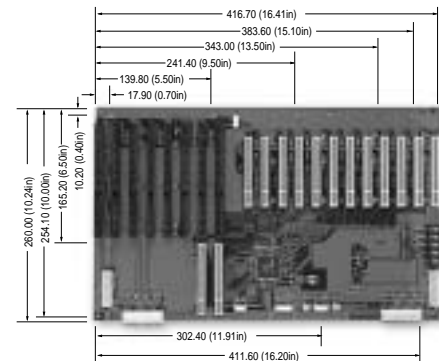

GHP-2220G
6xISA & 12xPCI & 2xPICMG CPU Slot(Single System)

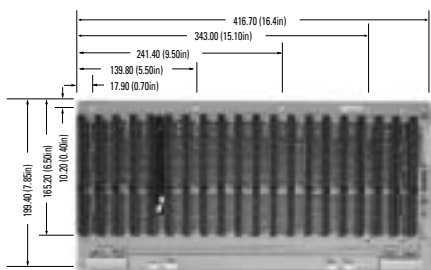

GHP-2020
20xISA Slot

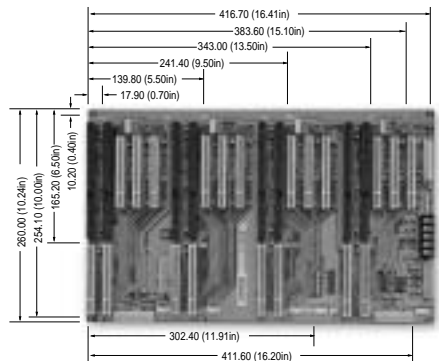

GHP-2220Q
12xPCI & 8xPICMG CPU Slot(Quad System)

Passive Backplane

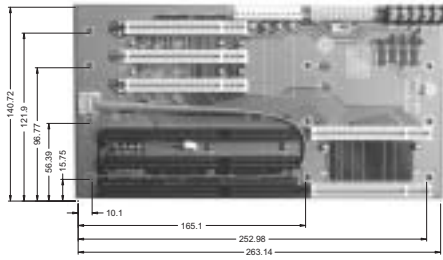

GHP-06P3

1xISA & 3xPCI & 2xPICMG CPU Slot (Single System)

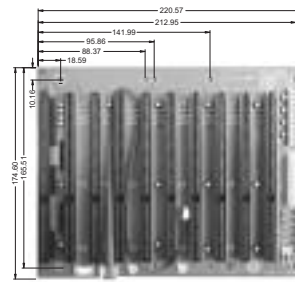

GHP-101-ATX

10xISA Slot (Single System)

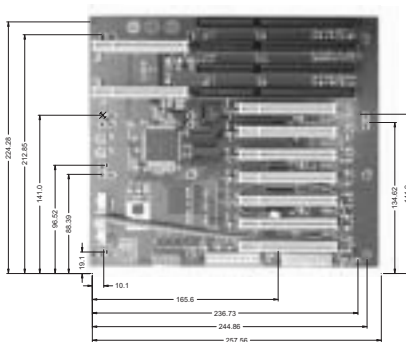

GHP-10P7-EI

2xISA & 7xPCI & 2xPICMG CPU Slot (Single System)



GHP-206B-AT

6xISA Slot (Single System)

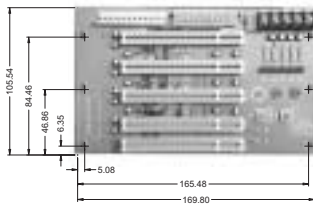

GHP-PCI4-ATX

5xPCI Slot (Single System)

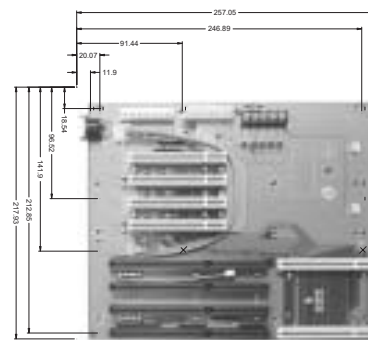

GHP-PCI-08P4

2xISA & 4xPCI & 2xPICMG CPU Slot (Single System)

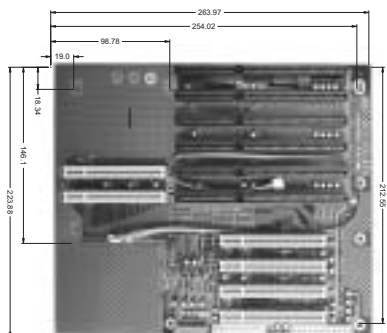

GHP-PCI10-ATX

4xISA & 4xPCI & 2xPICMG CPU Slot (Single System)

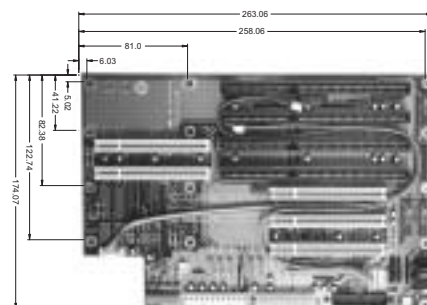

GHP-PCI6R-ATX

2xISA & 3xPCI & 2xPICMG CPU Slot (Single System)

19" Open Rack Series

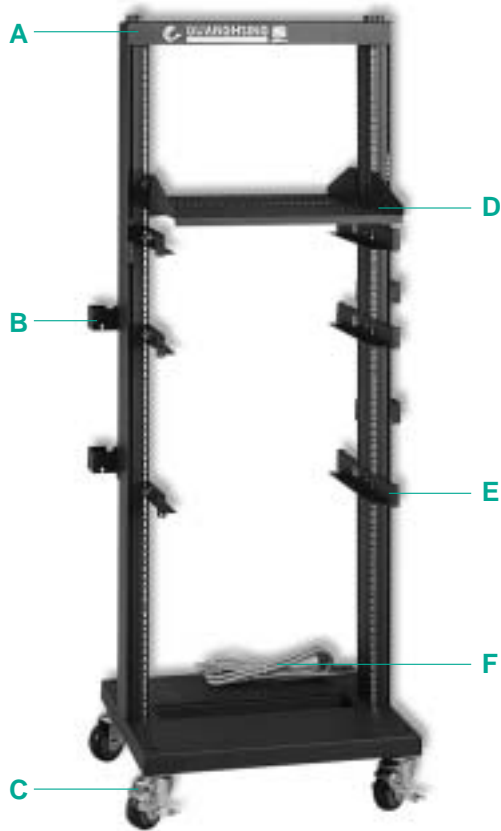

Specifications

- **Construction:** Aluminum Alloy
- **Color:** Beige or Black
- **Meet MIL-STD-167 & MIL-STD-810E Vibration Tests**
- **Applicable ANSI/EIA RS-310-C Standards**
- **Flexible & Easy Maintenance**
- **Standard Parts:** Main Frame(A) & 4xWheel(C) & 50xMounting Screws
- **Dimensions:**
 GHO-020: 540(W0)x1100(H0)x933(H1)x889(H2)x500(D0)mm
 21.3"(W0)x43.3"(H0)x36.7"(H1)x35.0"(H2)x19.7"(D0)
 GHO-035: 540(W0)x1767(H0)x1660(H1)x1556(H2)x500(D0)mm
 21.3"(W0)x69.6"(H0)x65.4"(H1)x61.3"(H2)x19.7"(D0)

Dimension

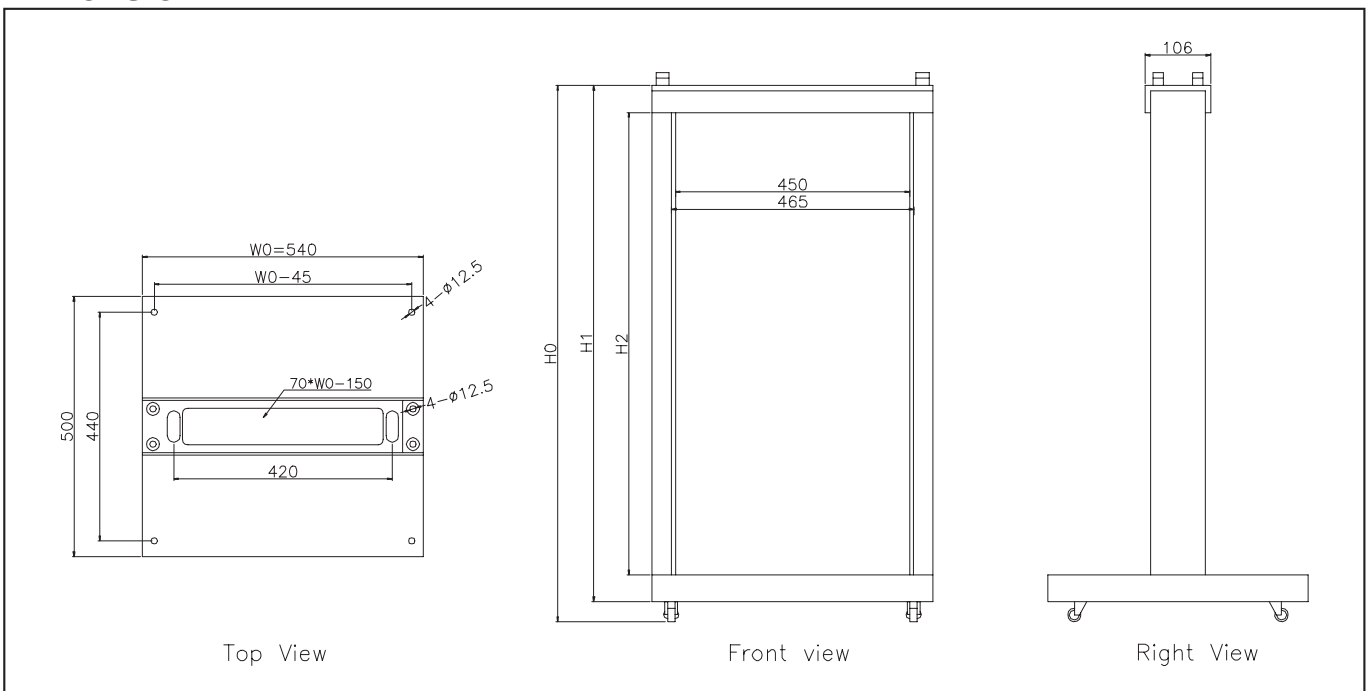

19" Open Rack Series

Optional Auxiliary Parts in Application

B



Cable Holder

- Used with Open Rack and to Keep any Cable line Tidy
- Model No.: GHO-H001
- Dimensions: 60(W)x80(H)x44(D)mm(2.4"x3.1"x1.7")

E



Mounting Support Bracket

- 1U High Bracket to mount Chassis
- Model No.: GHO-B400 (For Open Rack)
- Dimensions: 44(H)x500(D)mm(1.7"x19.7")

F



Mounting Support Bracket

- 1U High Bracket to mount Chassis
- Model No.: GHO-B500 (For 600mm Depth Cabinet)
- Dimensions: 44(H)x500(D)mm(1.7"x19.7")

D



Full Size Support Tray

- To mount Open Rack, 2U High, suitable for non-standard and heavy weight application, can supporting for 60kg
- Model No.: GHO-T2200
- Dimensions: 483(W)x44(H)x500(D)mm(19"x1.7"x19.7")

D



Half Size Support Tray

- To mount Open Rack, 2U High, suitable for non-standard and heavy weight application, can supporting for 25kg
- Model No.: GHO-T280
- Dimensions: 483(W)x88(H)x280(D)mm(19"x3.5"x11.0")
- Model No.: GHO-T400
- Dimensions: 483(W)x88(H)x400(D)mm(19"x3.5"x15.7")



Open Rack Application





Premier Computer Handels GmbH
Wöhlerstraße 6
22113 Hamburg (Germany)
Tel: +49(0)40 / 736161-0
Fax: +49(0)40 / 736161-33

e-mail: office@premiercomputer.de
HOME PAGE www.premiercomputer.de

January, 2006